

webMethods EntireX

Software AG IDL Editor

Version 9.10

April 2016

This document applies to webMethods EntireX Version 9.10 and all subsequent releases.

Specifications contained herein are subject to change and these changes will be reported in subsequent release notes or new editions.

Copyright © 1997-2016 Software AG, Darmstadt, Germany and/or Software AG USA, Inc., Reston, VA, USA, and/or its subsidiaries and/or its affiliates and/or their licensors.

The name Software AG and all Software AG product names are either trademarks or registered trademarks of Software AG and/or Software AG USA, Inc. and/or its subsidiaries and/or its affiliates and/or their licensors. Other company and product names mentioned herein may be trademarks of their respective owners.

Detailed information on trademarks and patents owned by Software AG and/or its subsidiaries is located at <http://softwareag.com/licenses>.

Use of this software is subject to adherence to Software AG's licensing conditions and terms. These terms are part of the product documentation, located at <http://softwareag.com/licenses/> and/or in the root installation directory of the licensed product(s).

This software may include portions of third-party products. For third-party copyright notices, license terms, additional rights or restrictions, please refer to "License Texts, Copyright Notices and Disclaimers of Third-Party Products". For certain specific third-party license restrictions, please refer to section E of the Legal Notices available under "License Terms and Conditions for Use of Software AG Products / Copyright and Trademark Notices of Software AG Products". These documents are part of the product documentation, located at <http://softwareag.com/licenses> and/or in the root installation directory of the licensed product(s).

Use, reproduction, transfer, publication or disclosure is prohibited except as specifically provided for in your License Agreement with Software AG.

Document ID: EXX-EEXXIDLEEDITOR-910-20181116

Table of Contents

Software AG IDL Editor	vii
1 About this Documentation	1
Document Conventions	2
Online Information and Support	2
Data Protection	3
2 Introduction to the Software AG IDL Editor	5
Introduction	6
Features of the IDL Editor	6
3 Using the Software AG IDL Editor	9
Starting the IDL Editor	10
IDL Editor Views	13
Context Menu of the IDL Editor	19
Editing an IDL File from the Outline View	20
4 Software AG IDL File	27
Introduction to the IDL File	28
IDL Data Types	29
Fixed and Unbounded Arrays	32
Rules for Coding IDL Files	32
Rules for Coding Group and Parameter Names	33
Rules for Coding Library, Library Alias, Program, Program Alias and Structure Names	34
Context Menu	34
5 Software AG IDL Grammar	37
Meta Definitions	38
Syntax of the IDL File	39
library-definition	39
program-definition	41
structure-definition	42
parameter-data-definition	43
simple-parameter-definition	45
group-parameter-definition	46
structure-parameter-definition (IDL)	47
array-definition	48
attribute-list	53
6 The Software AG IDL Compiler	57
Introduction	58
Starting the IDL Compiler	58
IDL Compiler Usage Examples	60
Writing your own Wrappers and Stubs	60
7 Writing Template Files for Software AG IDL Compiler	61
Coding Template Files	62
Using Output Statements in the Template File	63
Inserting Comments in the Template File	65

Using Verbatim Mode	66
Using Options	66
Specifying the Name of the Output File	66
Redirecting the Output to Standard Out	67
Using Template #if Preprocessing Statements	68
Using Template #include Preprocessing Statements	70
Using Template #trace Statement	70
8 Grammar for IDL Template Files	73
Software AG Template File Grammar	75
assign_statement	75
assign_integer_statement	76
assign_string_statement	76
block	77
compare_expression	77
compare_strings	78
compare_operator	78
control_statement	79
definition-statement	80
definition-of-base-type-template	81
definition-of-base-type	82
definition-of-direction-template	83
definition-of-group-template	83
definition-of-index-template	84
definition-of-line-number-format-template	84
definition-of-member-separator-template	85
definition-of-names-format-template	85
definition-of-OutBlank-template	86
definition-of-nest-level-format-template	86
definition-of-parent-identifier-template	87
definition-of-parent-index-template	87
definition-of-structure-template	88
definition-of-UnboundedArray-template	88
error_statement	89
execute_statement	90
file_handling_statement	91
if_statement	92
if_elif_extension	92
logical_compare_operator	93
loop_statement	93
loop_over_libraries	94
loop_over_parameters	95
loop_over_programs	95
loop_over_structures	96
loop_of_while	96
message_statement	97

output	97
output_character_sequence	98
output_control_ims	99
output_control_imsonly	99
output_control_lower_upper	100
output_control_sanitize	101
output_control_statement	103
output_control_verbose	104
output_escape_sequence	104
output_formatting_sequence	105
output_of_variable	106
output_statement	106
output_substitution_sequence	107
parameter_list	111
return_list	111
return_statement	112
statement	112
string	113
string_with_expression_contents	113
substring_statement	114
UnsupportedProgram_statement	115
variable_index	116
variable_name	116
variable_of_type_indexed_string	117
variable_of_type_integer	117
variable_of_type_string	118

Software AG IDL Editor

Software AG IDL (Interface Definition Language) is a language that lets a program or object (the client) written in one language communicate with another program written in another language (the server). An interface definition language works by requiring a program's interfaces to be described in an interface object or slight extension of the program that is compiled into it.

Software AG IDL is used to define an interface between the client and the server. These definitions are contained in a Software AG IDL file. IDL compilers read IDL files and generate interface objects or descriptions from the definitions they contain.

The Software AG IDL Editor is a syntax-aware editor for Software AG IDL files. A content outline view enables operations on the IDL tree. Other features include syntax highlighting, content assist and a Problems view for resolving IDL syntax errors.

<i>Introduction</i>	This document gives an introduction and overview of features of the IDL Editor.
<i>Using the IDL Editor</i>	This document describes the usage of the IDL Editor; starting the editor; views and context menu.
IDL File	This document contains a descriptive introduction to IDL data files; IDL data types; rules for coding IDL files.
<i>IDL Grammar</i>	This document explains the syntax of IDL files in a formal notation.
<i>IDL Compiler</i>	Starting the IDL Compiler; usage examples; writing your own wrappers and stubs.
<i>Template Files</i>	Writing your own template files for Software AG IDL Compiler.
<i>Grammar for IDL Template Files</i>	Grammar for IDL template files.

1 About this Documentation

- Document Conventions 2
- Online Information and Support 2
- Data Protection 3

Document Conventions

Convention	Description
Bold	Identifies elements on a screen.
Monospace font	Identifies service names and locations in the format <i>folder.subfolder.service</i> , APIs, Java classes, methods, properties.
<i>Italic</i>	Identifies: Variables for which you must supply values specific to your own situation or environment. New terms the first time they occur in the text. References to other documentation sources.
Monospace font	Identifies: Text you must type in. Messages displayed by the system. Program code.
{ }	Indicates a set of choices from which you must choose one. Type only the information inside the curly braces. Do not type the { } symbols.
	Separates two mutually exclusive choices in a syntax line. Type one of these choices. Do not type the symbol.
[]	Indicates one or more options. Type only the information inside the square brackets. Do not type the [] symbols.
...	Indicates that you can type multiple options of the same type. Type only the information. Do not type the ellipsis (...).

Online Information and Support

Software AG Documentation Website

You can find documentation on the Software AG Documentation website at <http://documentation.softwareag.com>. The site requires credentials for Software AG's Product Support site Empower. If you do not have Empower credentials, you must use the TECHcommunity website.

Software AG Empower Product Support Website

If you do not yet have an account for Empower, send an email to empower@softwareag.com with your name, company, and company email address and request an account.

Once you have an account, you can open Support Incidents online via the eService section of Empower at <https://empower.softwareag.com/>.

You can find product information on the Software AG Empower Product Support website at <https://empower.softwareag.com>.

To submit feature/enhancement requests, get information about product availability, and download products, go to [Products](#).

To get information about fixes and to read early warnings, technical papers, and knowledge base articles, go to the [Knowledge Center](#).

If you have any questions, you can find a local or toll-free number for your country in our Global Support Contact Directory at https://empower.softwareag.com/public_directory.asp and give us a call.

Software AG TECHcommunity

You can find documentation and other technical information on the Software AG TECHcommunity website at <http://techcommunity.softwareag.com>. You can:

- Access product documentation, if you have TECHcommunity credentials. If you do not, you will need to register and specify "Documentation" as an area of interest.
- Access articles, code samples, demos, and tutorials.
- Use the online discussion forums, moderated by Software AG professionals, to ask questions, discuss best practices, and learn how other customers are using Software AG technology.
- Link to external websites that discuss open standards and web technology.

Data Protection

Software AG products provide functionality with respect to processing of personal data according to the EU General Data Protection Regulation (GDPR). Where applicable, appropriate steps are documented in the respective administration documentation.

2 Introduction to the Software AG IDL Editor

- Introduction 6
- Features of the IDL Editor 6

The Software AG IDL Editor is a syntax-aware editor for Software AG IDL files. A content outline view enables operations on the IDL tree. Other features include syntax highlighting, content assist and a Problems view for resolving IDL syntax errors.

Introduction

The IDL Editor is used for processing IDL files (files with extension “.idl”).

➤ To start the IDL Editor

- Select an existing IDL file and open this using the context menu, or double-click on the file.

Or:

Start the IDL Editor as any other Eclipse new wizard.

In addition to a Text view, the editor supports the following views:

Outline View

In the Outline view, the structure of the IDL file is displayed in a tree structure. The context menu of the Outline view provides a variety of commands for manipulating the structure of the IDL. See [IDL Editor Outline View](#).

Properties View

The Properties view displays various attributes of the element selected in the Text view or Outline view. You can also edit these attributes in this view. See [IDL Editor Properties View](#).

Problems View

The Problems view describes syntax errors in the IDL file. See [IDL Editor Problems View](#).

Features of the IDL Editor

Content Assist

Enables text-dependent completion when requested. Content assist offers a pop-up from which you can choose one of the suggestions.

Syntax Highlighting

Certain parts of the IDL document are displayed with a color coding:

- purple: IDL keywords
- brown: comments
- green: string constants.

3

Using the Software AG IDL Editor

- Starting the IDL Editor 10
- IDL Editor Views 13
- Context Menu of the IDL Editor 19
- Editing an IDL File from the Outline View 20

The Software AG IDL Editor is a syntax-aware editor for Software AG IDL files. A content outline view enables operations on the IDL tree. Other features include syntax highlighting, content assist and a Problems view for resolving IDL syntax errors.

Starting the IDL Editor

> To start the IDL Editor

- Select an existing IDL file and open this using the context menu, or double-click on the file.

Or:

Start the IDL Editor as any other Eclipse new wizard.

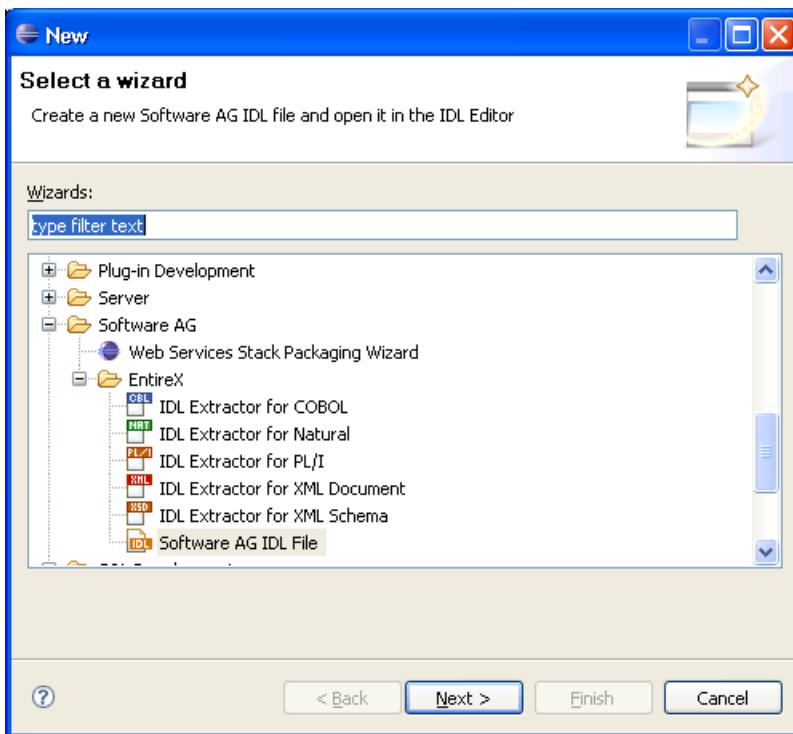

Specify the name and the container of the new IDL file you want to create. The container is a project or a folder in a project. If the container does not exist, it will be created interactively. Enter the names of a first library, a first program and a first parameter to get an initial IDL file. The names and the properties can be changed later. "myLibrary", "myProgram" and "myParameter" are provided as default values.

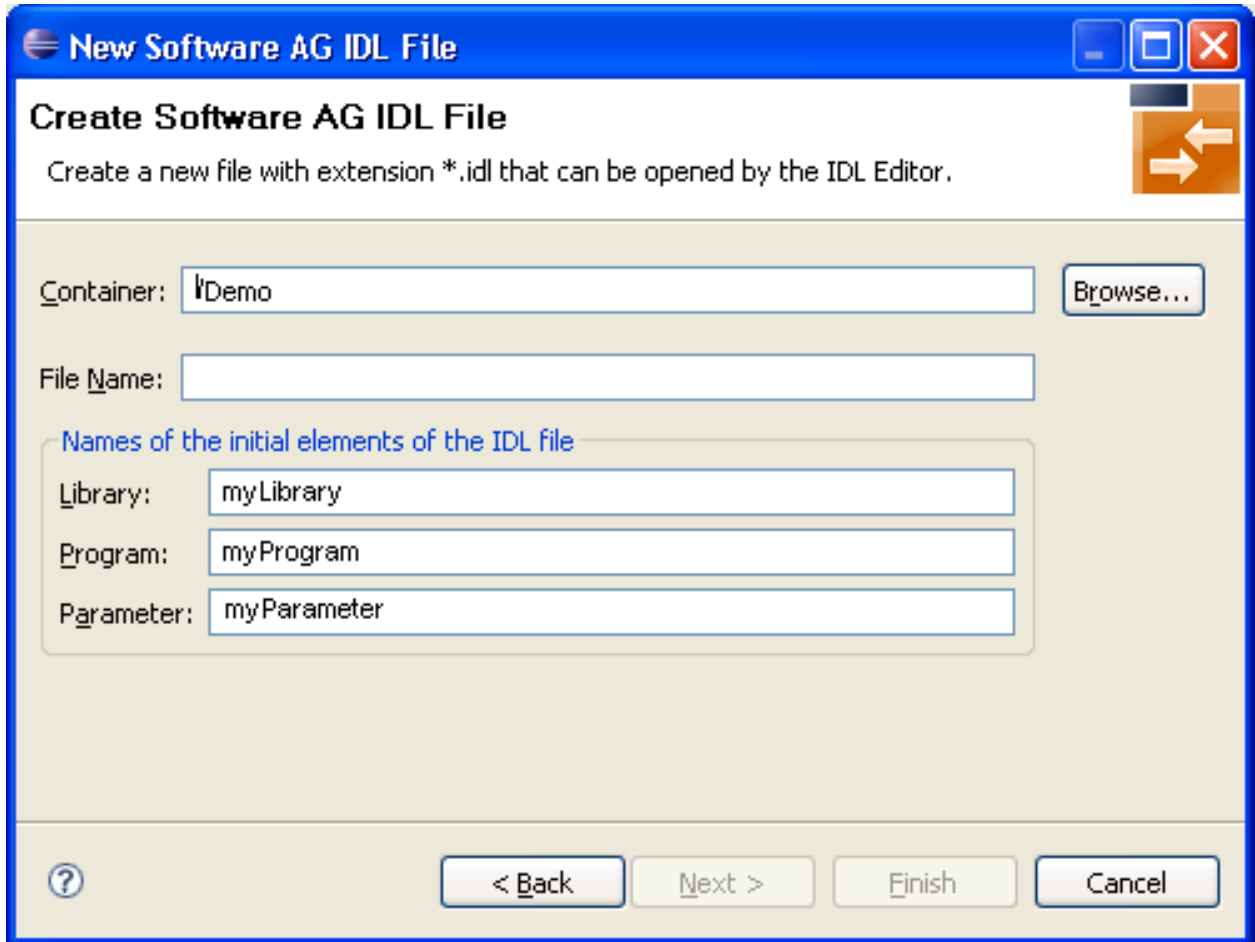

The IDL file is then displayed in the IDL Editor. In addition to a Text view, the editor supports the following views:

- *IDL Editor Outline View*
- *IDL Editor Properties View*
- *IDL Editor Problems View*

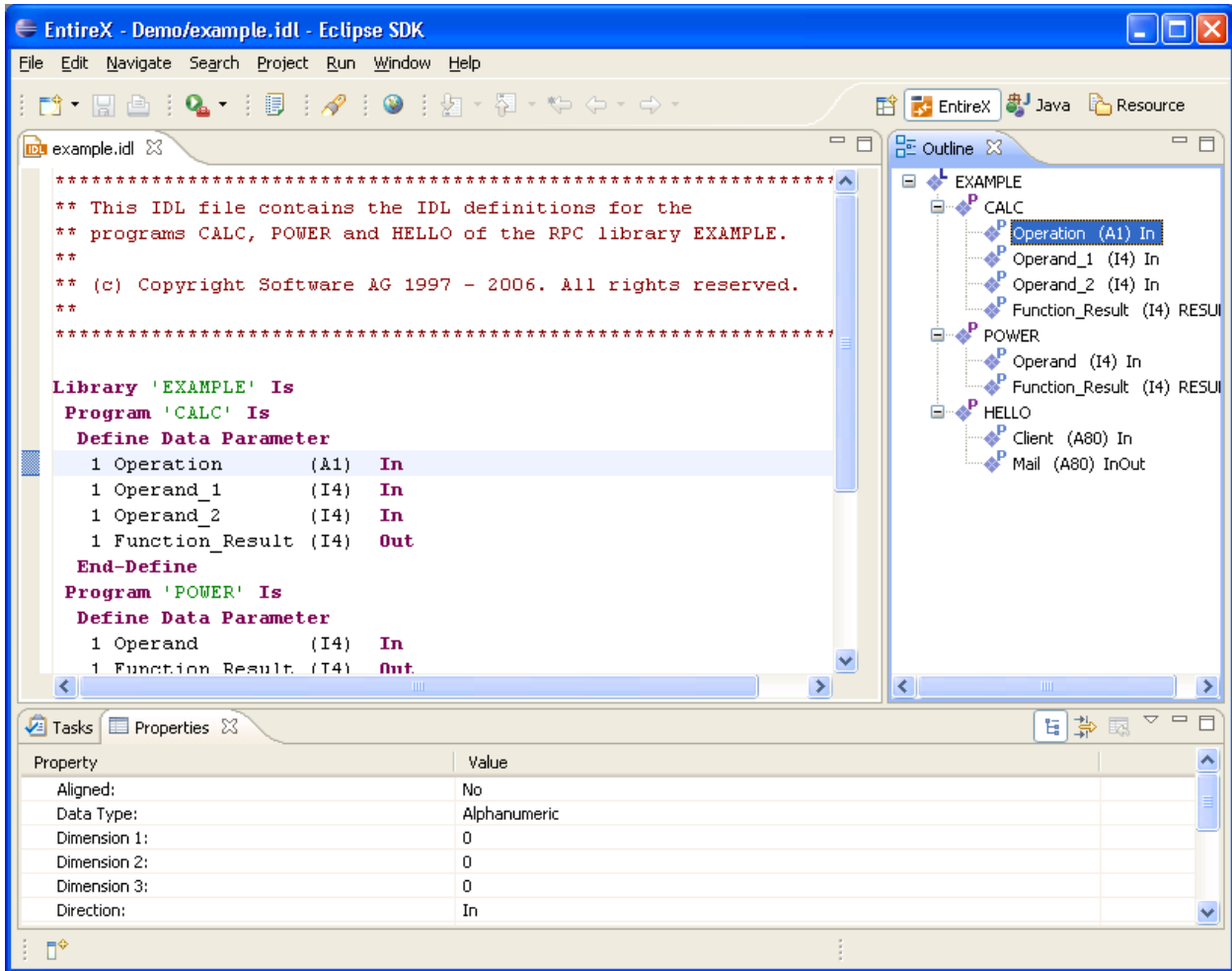

IDL Editor Views

- IDL Editor Outline View
- Context Menu of the Outline View
- Outline View Drag-and-Drop
- IDL Editor Properties View
- IDL Editor Problems View

IDL Editor Outline View

In the Outline view, the structure of the IDL file is displayed in a tree structure. The nodes are the elements of the IDL: libraries, programs, structures and parameters. The context menu of the Outline view provides a variety of commands for manipulating the structure of the IDL.

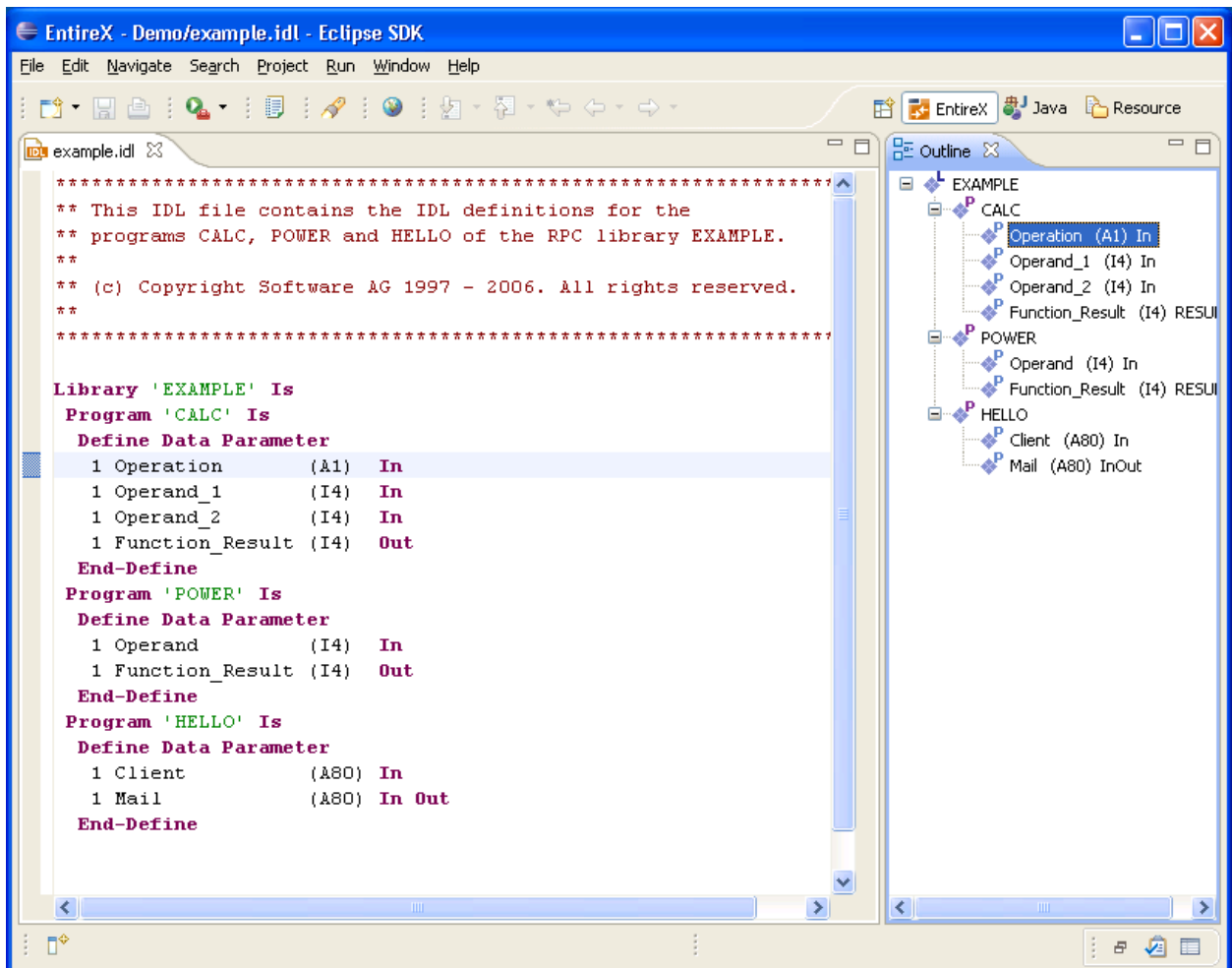

Context Menu of the Outline View

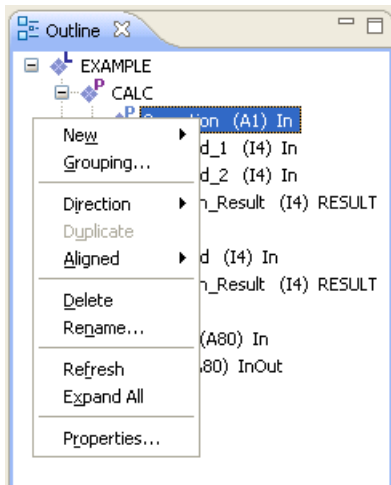

Command	Description
New	<ul style="list-style-type: none"> ■ Library Inserts a library before the selected library. Enabled only for libraries. ■ Program Inserts a program at the first position of the current library if a library is selected. If a program is selected, a new program is inserted before the selected program. The same applies if a structure is selected. If a parameter is selected, a new program is inserted before the program or structure containing the selected parameter. ■ Structure Inserts a structure at the first position of the current library if a library is selected. If a program is selected, the new structure is inserted before the selected program. The same applies if a structure is selected. If a parameter is selected, a new structure is inserted before the program or structure containing the selected parameter. ■ Parameter Inserts a new parameter at the first position of the current program or structure if a program or structure is selected. If a parameter is selected, the new parameter is inserted before the selected parameter. <p>The New command applies only to single selections.</p>
Grouping...	Inserts a group that contains the selected parameters.
Direction	<ul style="list-style-type: none"> ■ InOut Changes the direction to InOut. ■ In Changes the direction to In.

Command	Description
	<ul style="list-style-type: none"> ■ Out Changes the direction to Out. <p>If a program is selected, the direction of all parameters in this program is changed.</p>
Duplicate	Duplicates the selected program and creates a unique name for this program.
Aligned	<ul style="list-style-type: none"> ■ On Parameter is aligned. ■ Off Parameter is not aligned.
Delete	Deletes the node.
Rename	Renames the node.
Refresh	Refreshes the whole tree, that is, makes it synchronized with the text in the editor.
Expand All	Opens the nodes of the tree.
Properties...	Displays the properties of the selected node.

Outline View Drag-and-Drop

Drag-and-drop operation is enabled for the tree structure of the IDL file (represented in the Outline view). That is, you can drag an individual library, structure, program or parameter to a target element. You cannot drag more than one object at a time.

The table below describes the permitted drag-and-drop functions, where **Drag Source** is the element being dragged and the **Drop Target** is the element that receives the drag source.

Drop Target / Drag Source	Parameter, Group	Program	Structure	Library
Parameter, Group	x	x	x	
Program		x	x	x
Structure		x	x	x
Library				x

For example, a parameter can be dragged to a structure, but not to a library.

IDL Editor Properties View

The Properties view displays various attributes of the element selected in the Text view or Outline view. You can also edit these attributes in this view.

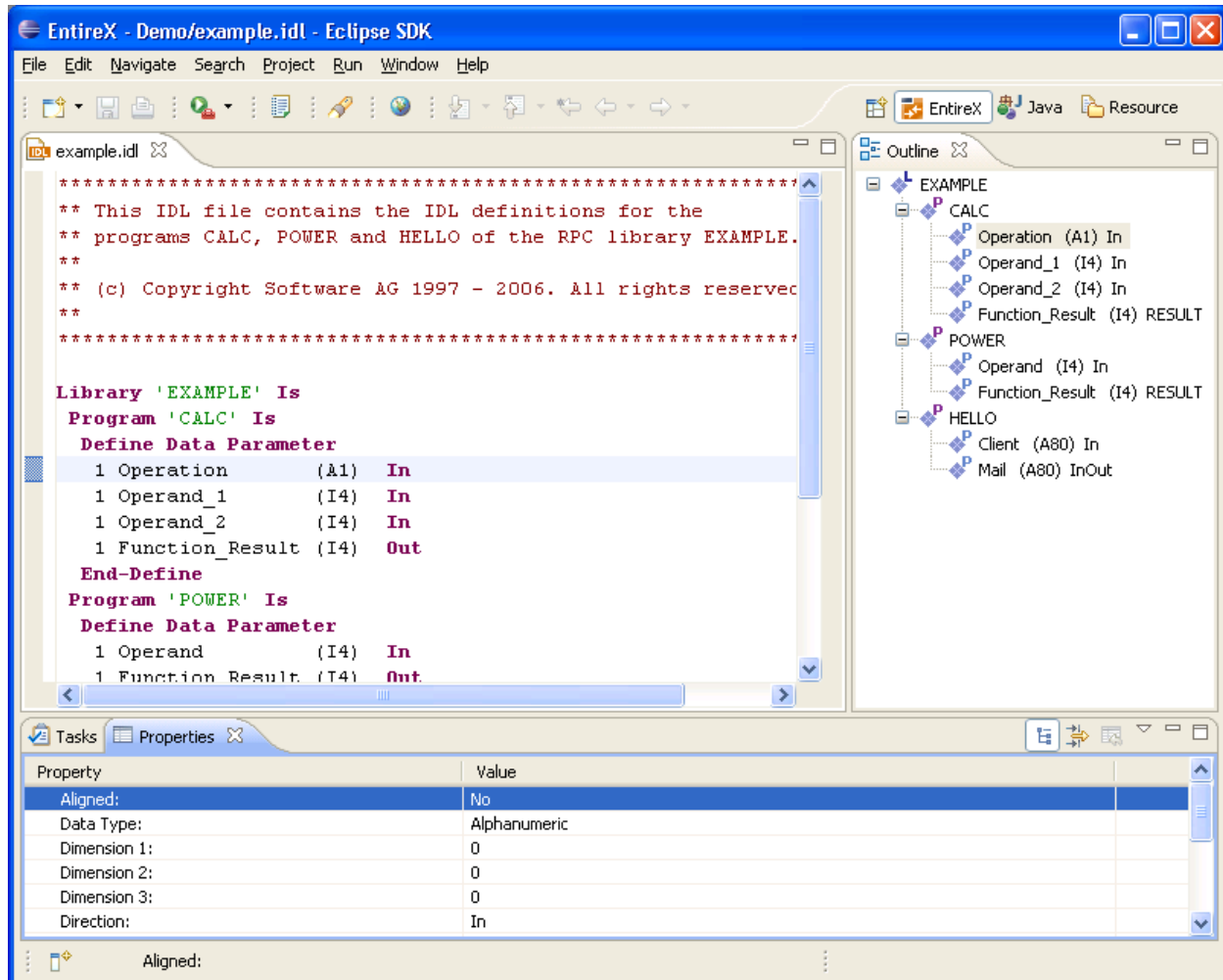

Library and Program

Property	Description
Alias	Alias of the library or program.
Name	Name of the library or program.
Preceding comment lines	Any comment in a preceding line or lines that applies to this line is displayed here. You can also add here a comment to this library or program in a definition line.
Same-line comment	Any comment in the current line is displayed here. You can also add a comment to the current line.

Structure

Property	Description
Name	Name of the library or program.
Preceding comment lines	Any comment in a preceding line or lines that applies to this line is displayed here. You can also add here a comment to this library or program in a definition line.
Same-line comment	Any comment in the current line is displayed here. You can also add a comment to the current line.

Parameter

Property	Description
Aligned	Specifies whether the current line contains an aligned statement.
Data Type	Here you can select data types from a drop-down list.
Dimension 1	First array dimension.
Dimension 2	Second array dimension.
Dimension 3	Third array dimension.
Name	Name of the parameter.
Preceding comment lines	Any comment in a preceding line or lines that applies to this line is displayed here. You can also add here a comment to this parameter.
Same-line comment	Any comment in the current line is displayed here. You can also add a comment to the current line.
Size and precision	Size and precision of the parameter.
Structure reference	If a structure is referenced, its name is displayed here.

IDL Editor Problems View

The Problems view documents syntax errors in the current IDL file, depending on the filter settings of the view. Only a document that is free of syntax errors can be displayed in the Outline view. Additionally, the line containing the error is marked with an error symbol and flagged to the right of the scrollbar.

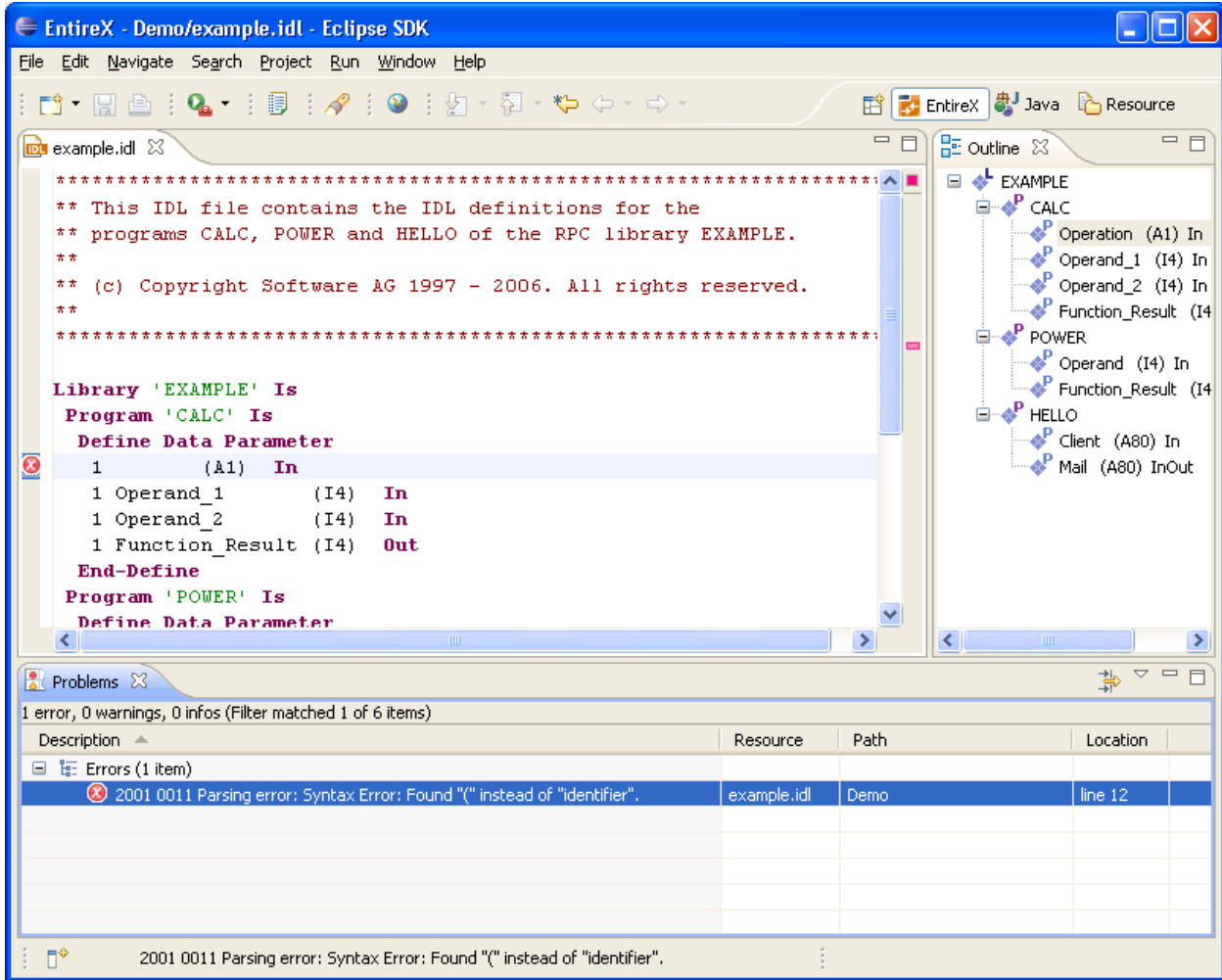

Context Menu of the IDL Editor

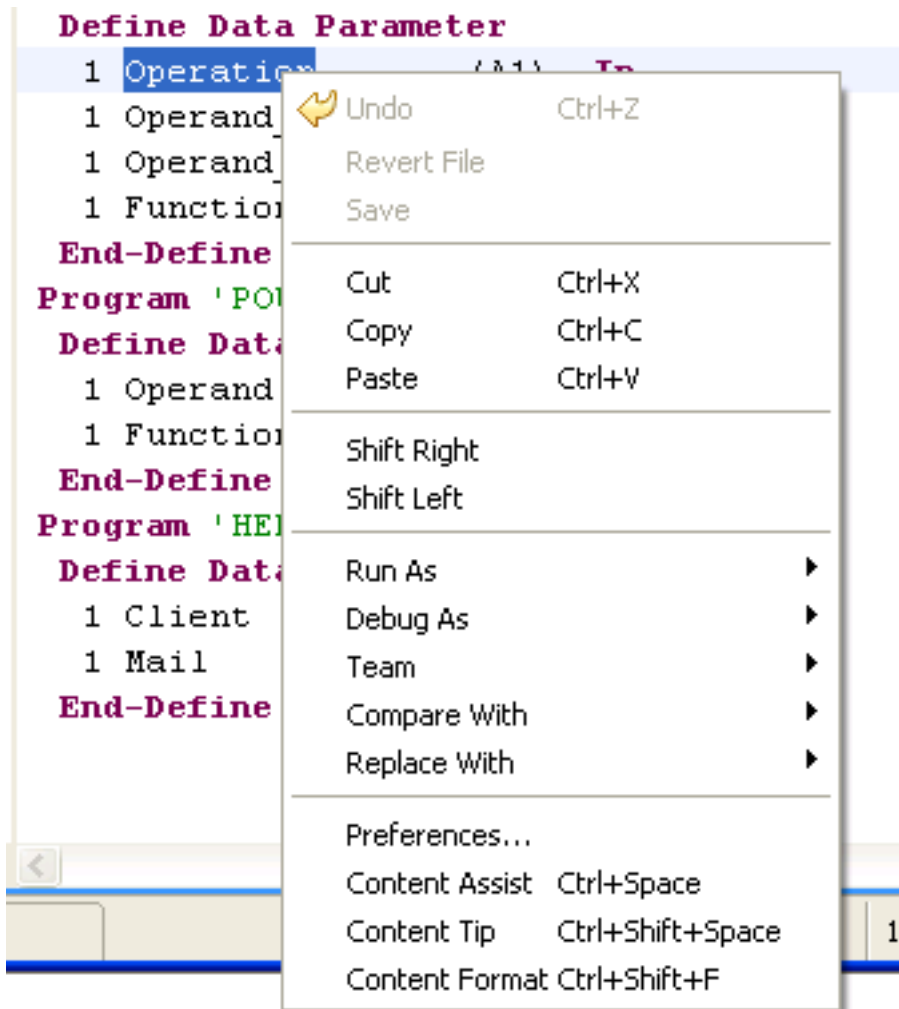

In addition to standard editor commands such as Undo, Revert File, Cut, Copy, Paste, Save etc., the context menu of the IDL Editor view offers two additional commands for shifting an element in the text: Shift Right to add a tab, and Shift Left to remove a tab.

Editing an IDL File from the Outline View

This example describes the operation of the IDL file outline context menu. These operations allow you to insert new IDL syntax elements without detailed knowledge of the syntax.

In this example we generate an IDL file by using the Software AG IDL File Wizard. The **Outline** view is opened (if it is not open already).

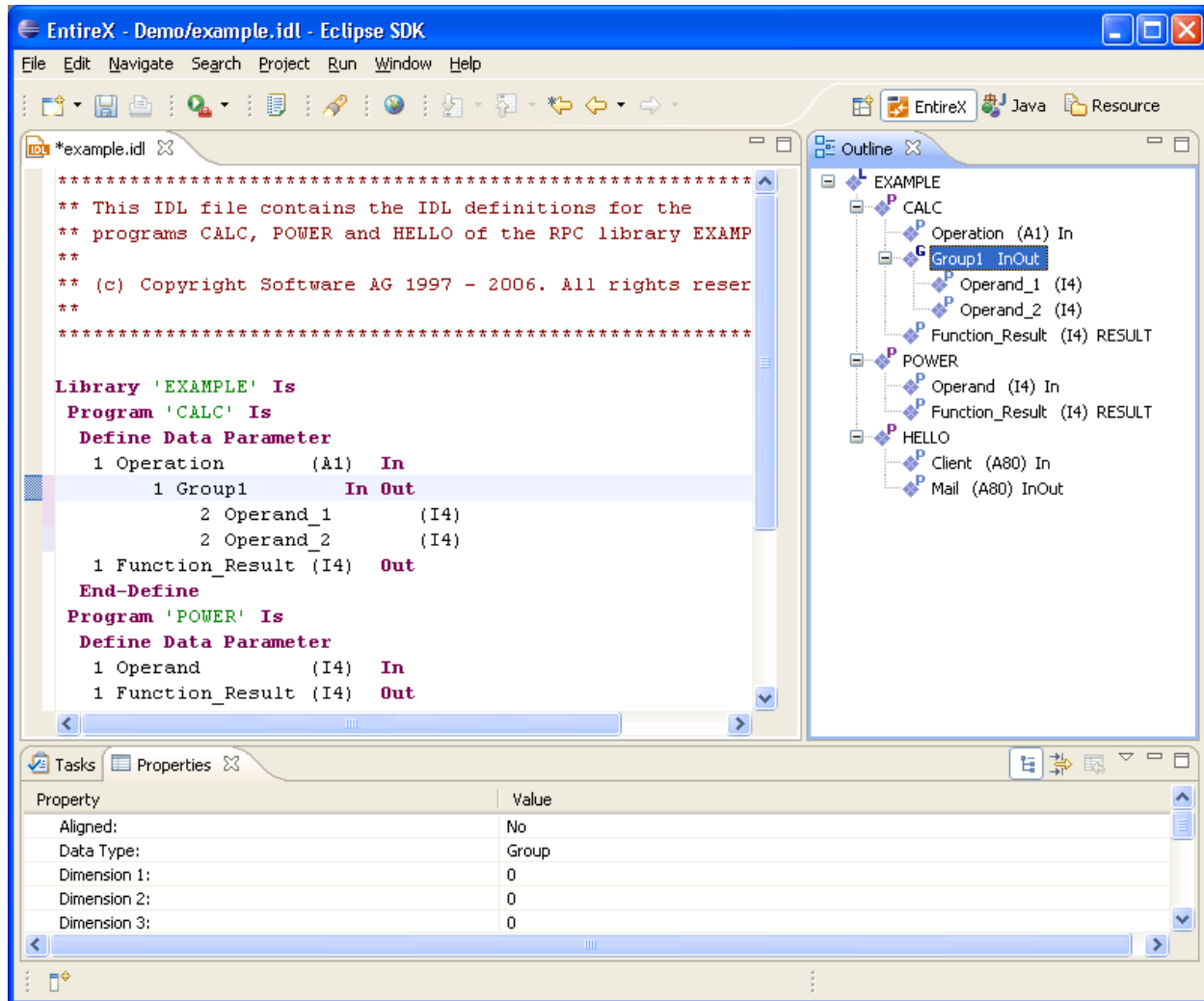

We can change the name of the library for example by selecting the library and choosing **Rename** in the context menu. The same applies to program and parameters.

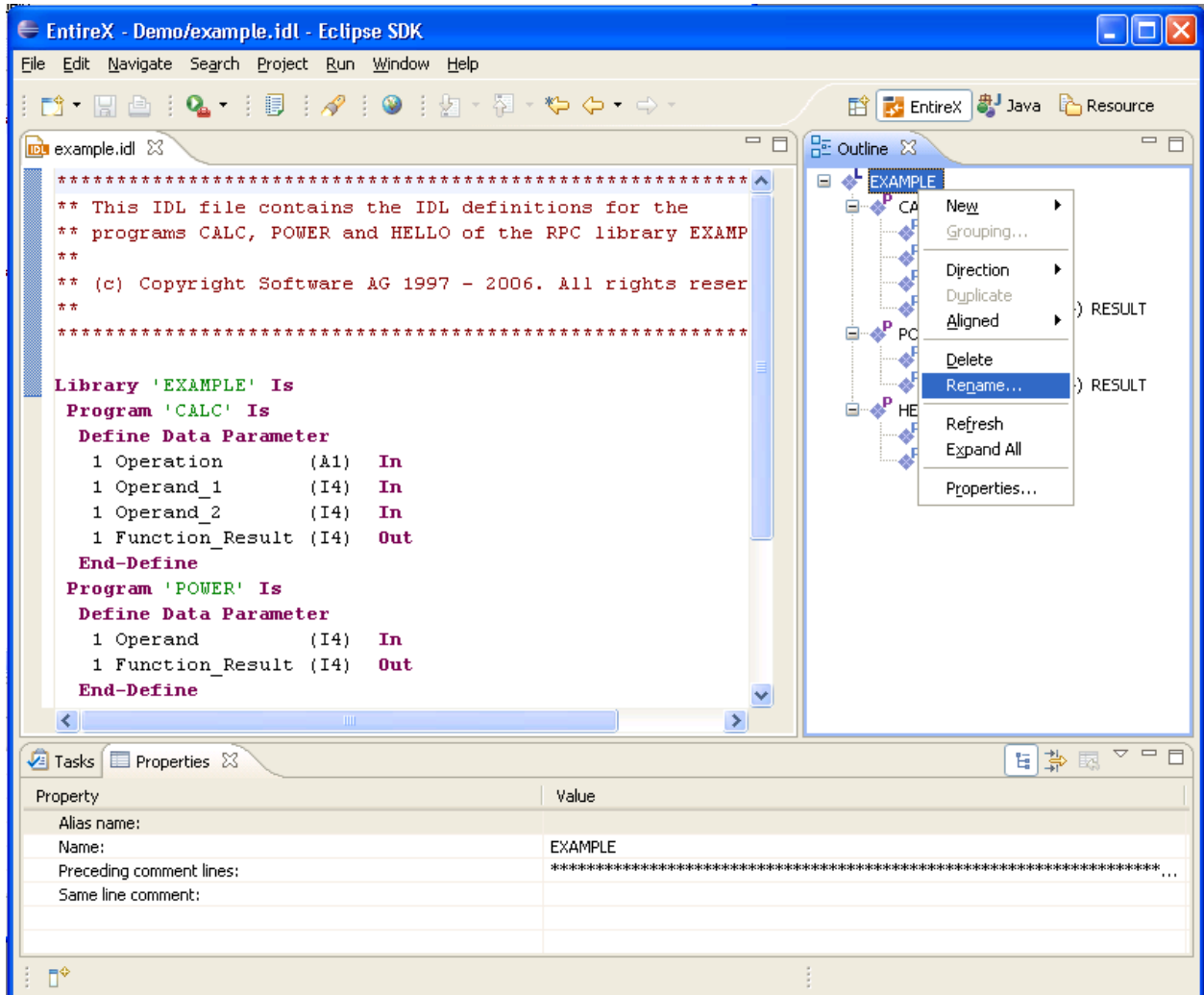

Adding a New Element

Choose the **New...** submenu of the context menu. To add an additional library to the IDL file, choose **Library**.

A **Library Properties** dialog is displayed, where you can enter the name of the library, the alias and comments.

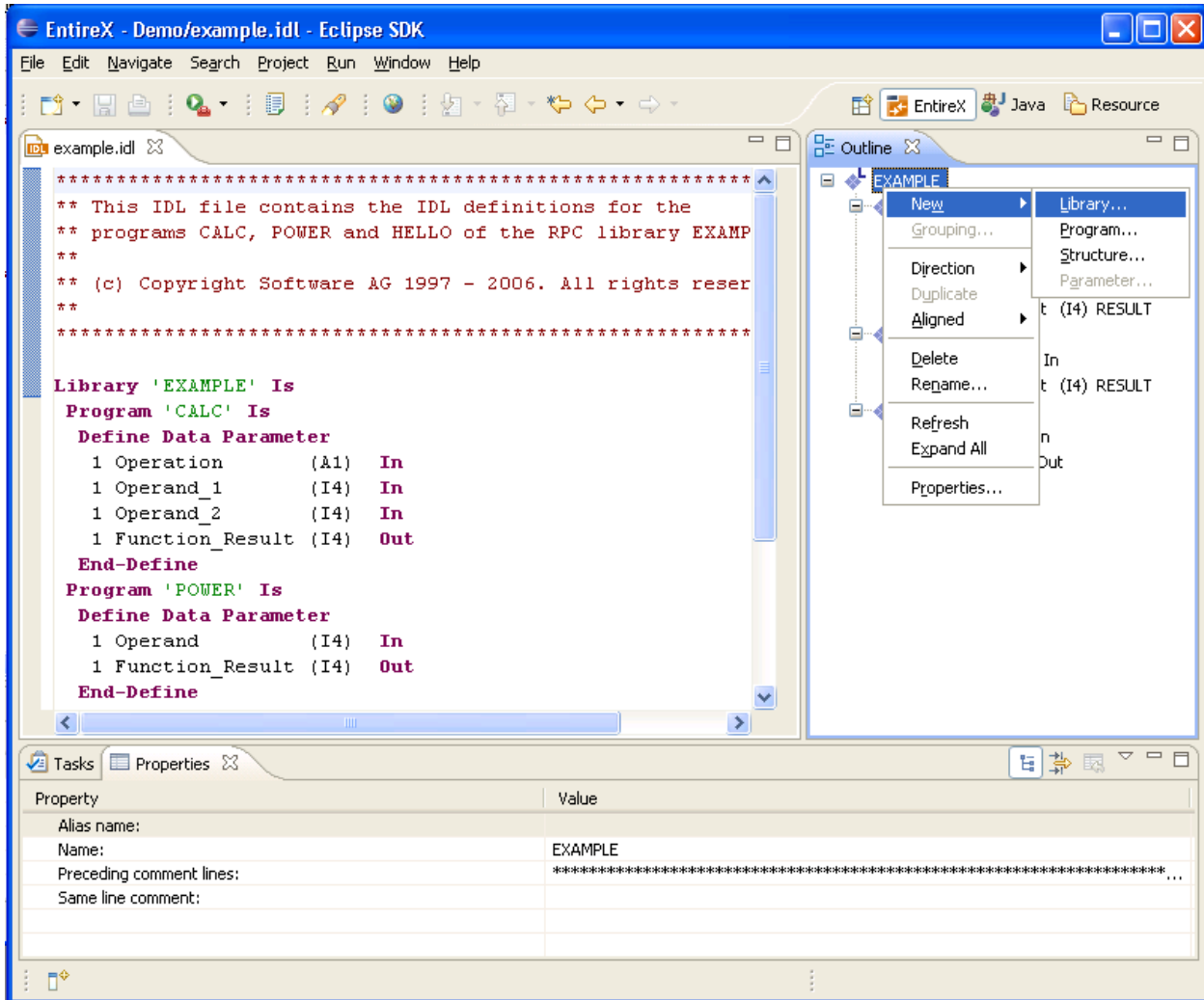

Select a parameter and choose **Properties** in the context menu. In the **Parameter properties** dialog you can set all required properties.

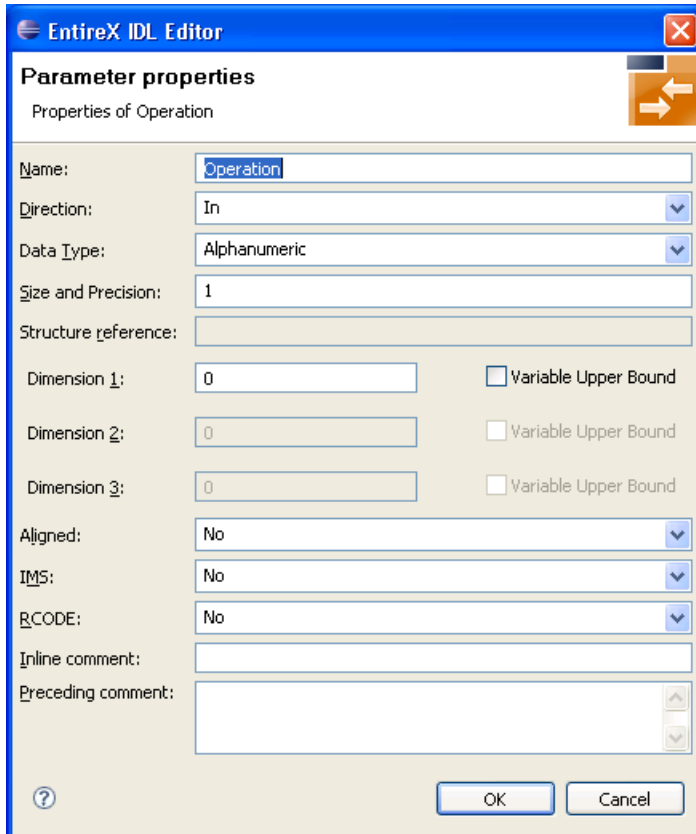

The properties of libraries, programs and structures are changed in a similar way.

Grouping

To group these two parameters, select both parameters and choose **Grouping** in the context menu. This inserts a new group into the program. The new group contains the two parameters.

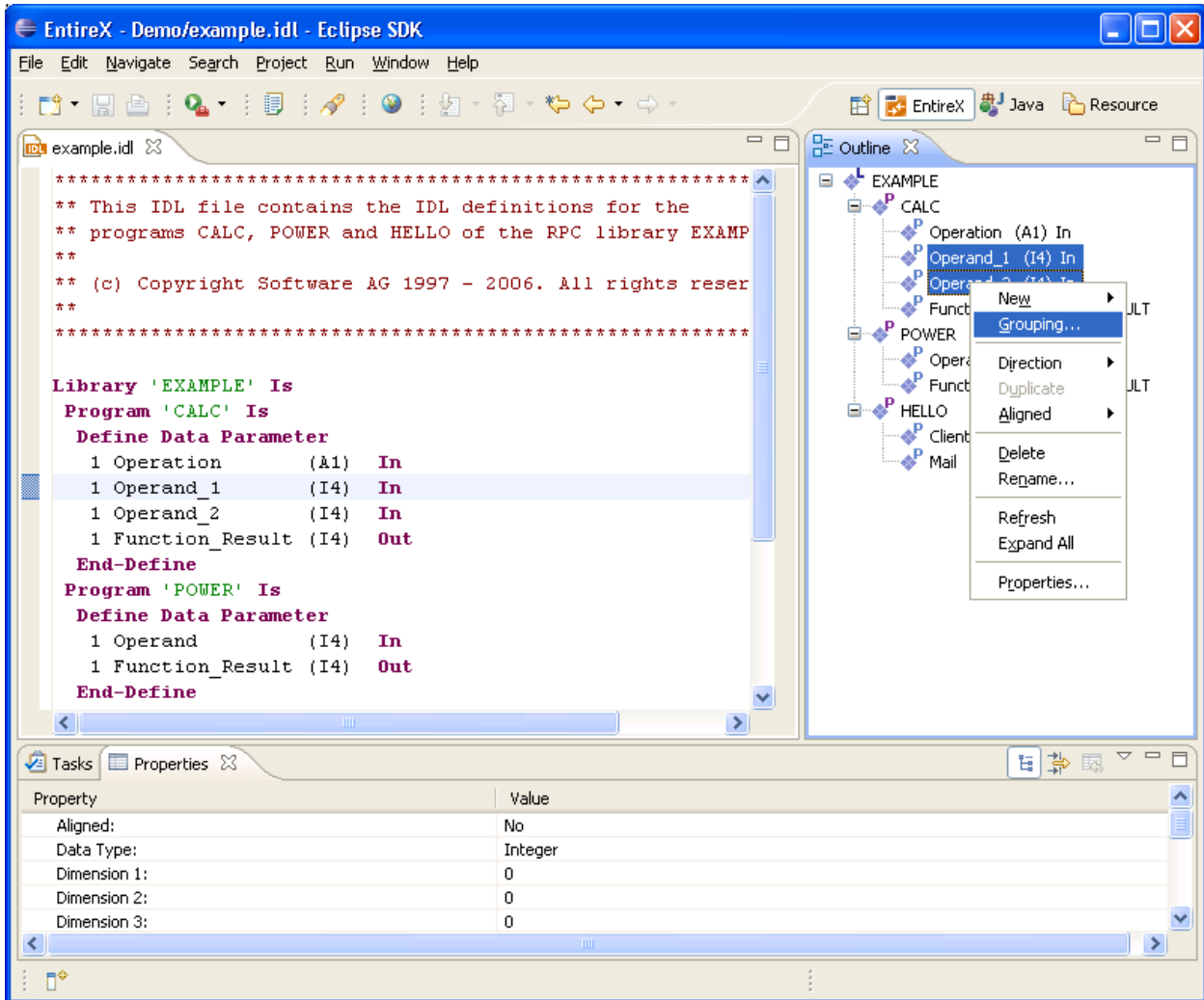

The screenshot shows a dialog box titled "EntireX IDL Editor" with a sub-title "Parameter properties" and the text "Properties of new group". The dialog contains the following fields and controls:

- Name:** Text box containing "Group1".
- Direction:** Dropdown menu set to "In Out".
- Data Type:** Dropdown menu set to "Group".
- Size and Precision:** Text box containing "0".
- Structure reference:** Empty text box.
- Dimension 1:** Text box containing "0" and a checkbox labeled "Variable Upper Bound" (unchecked).
- Dimension 2:** Text box containing "0" and a checkbox labeled "Variable Upper Bound" (unchecked).
- Dimension 3:** Text box containing "0" and a checkbox labeled "Variable Upper Bound" (unchecked).
- Aligned:** Dropdown menu set to "No".
- IMS:** Dropdown menu set to "No".
- R_CODE:** Dropdown menu set to "No".
- Inline comment:** Empty text box.
- Preceding comment:** Empty text box with up and down arrow buttons on the right.

At the bottom left is a help icon (?). At the bottom right are "OK" and "Cancel" buttons.

In the **Parameter Properties** dialog box you can enter all the settings required for this group.

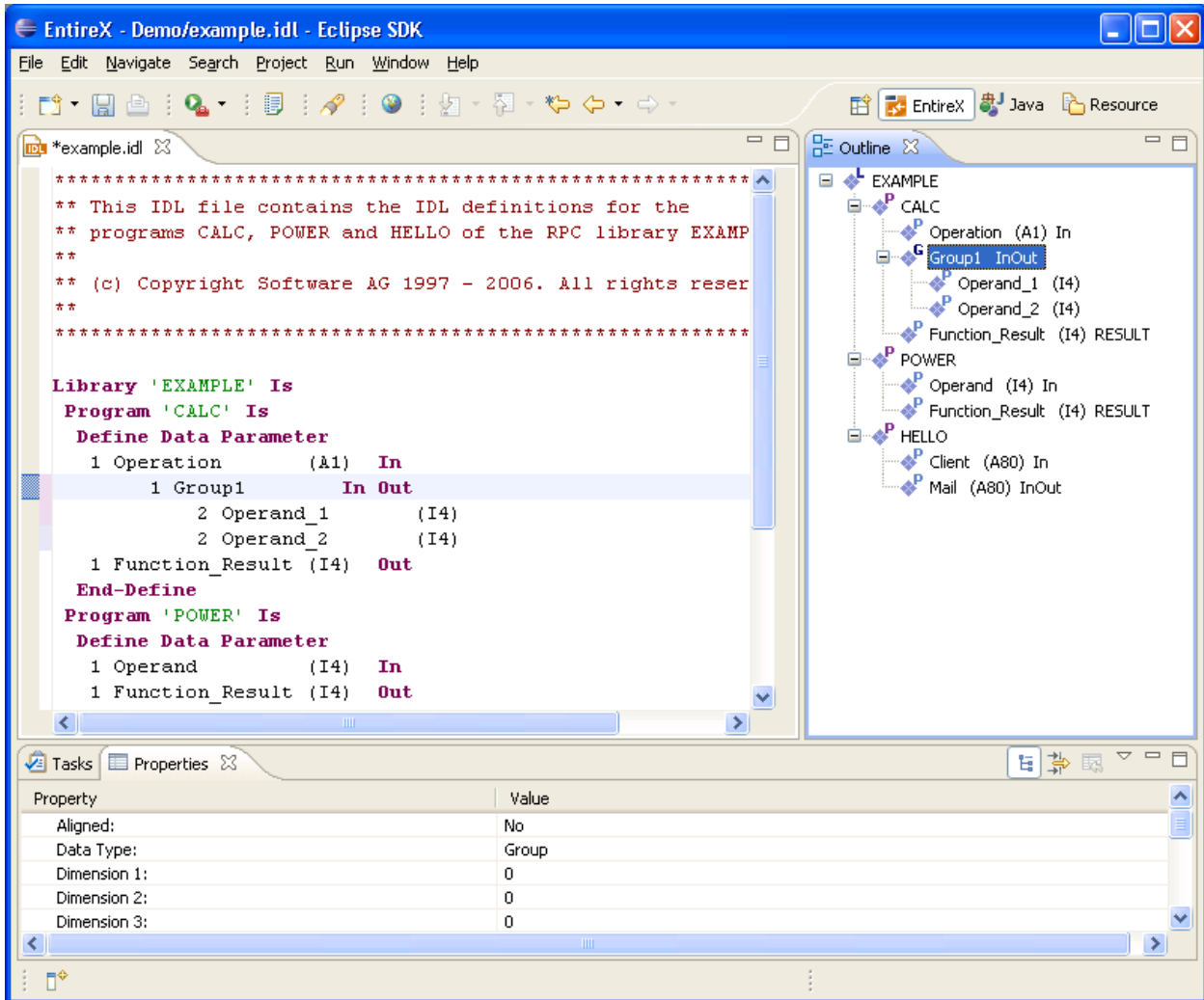

4 Software AG IDL File

- Introduction to the IDL File 28
- IDL Data Types 29
- Fixed and Unbounded Arrays 32
- Rules for Coding IDL Files 32
- Rules for Coding Group and Parameter Names 33
- Rules for Coding Library, Library Alias, Program, Program Alias and Structure Names 34
- Context Menu 34

A Software AG IDL file contains definitions of the interface between client and server. The IDL file is used by Software AG wrappers to generate RPC clients, RPC servers and tester etc. on the basis of these definitions. The IDL file can be edited by the IDL Editor provided by plug-ins for Eclipse.

This document contains a descriptive introduction to IDL files. The syntax of IDL files in a formal notation is given under [Software AG IDL Grammar](#).

Introduction to the IDL File

The IDL's syntax looks similar to a Software AG Natural parameter data definition statement.

```
Library 'EXAMPLE' Is
  Program 'CALC' Is
    Define Data Parameter
      1 Operator      (A1) In
      1 Operand_1    (I4) In
      1 Operand_2    (I4) In
      1 Function_Result (I4) Out
    End-Define
```

The syntax is described in a formal notation under [Software AG IDL Grammar](#).

IDL Data Types

The table below uses the following metasympols and informal terms for the IDL.

- The metasympols [and] surround optional lexical entities.
- The informal term *number* (or in some cases *number1.number2*) is a sequence of numeric characters, for example 123.

Type and Length	Description	Example	See Notes
<i>Anumber</i>	Alphanumeric	A100	1, 2, 7, 16, 19
AV	Alphanumeric variable length	AV	1, 2, 7, 16, 19, 20
<i>AVnumber</i>	Alphanumeric variable length with maximum length	AV100	1, 2, 7, 16, 19, 20
<i>Bnumber</i>	Binary	B10	1, 2, 14
BV	Binary variable length	BV	1, 2, 14, 20
<i>BVnumber</i>	Binary variable length with maximum length	BV128	1, 2, 14, 20
D	Date	D	3, 4, 13
F4	Floating point (small)	F4	11, 13, 15
F8	Floating point (large)	F8	12, 13, 15
I1	Integer (small)	I1	8
I2	Integer (medium)	I2	9
I4	Integer (large)	I4	10
<i>Knumber</i>	Kanji	K20	1, 2, 7, 16, 17, 19
KV	Kanji variable length	KV	1, 2, 7, 16, 17, 19, 20
<i>KVnumber</i>	Kanji variable length with maximum length	KV200	1, 2, 7, 16, 17, 19, 20
L	Logical	L	3, 13
<i>Nnumber1[.number2]</i>	Unpacked decimal	N8 or N8.2	6
<i>NUnumber1[.number2]</i>	Unpacked decimal unsigned	NU2 or NU6.2	6
<i>Pnumber1[.number2]</i>	Packed decimal	P12 or P10.3	6
<i>PUnumber1[.number2]</i>	Packed decimal unsigned	PU3 or PU4.2	6
T	Time	T	3, 5, 13
<i>Unumber</i>	Unicode	U100	2, 18
UV	Unicode variable length	UV	2, 18, 20
<i>UVnumber</i>	Unicode variable length with maximum length	UV200	2, 18, 20

Note that equivalents of the data types are not necessarily supported in every target programming language environment. Also, value ranges of the mapped data type can differ. See *Mapping Software AG IDL Data Types* in the respective Wrapper or language-specific documentation.

Notes:

1. There is, however, an absolute limit (1 GB) which cannot be exceeded.
2. The maximum length you can specify depends on your hardware and software configuration (apart from this product).
3. The length is implicit and must not be specified.
4. The supported range is from 1.1.0001 up to 31.12.9999. Dates BC (before the birth of Christ) are not supported.

It is also possible to transfer 1.1.0000 as a value. This is a special value (because there is no year 0) and denotes “no date” is given. The no date value is the internal state of a #DATE variable (Natural type D) after a RESET #DATE is executed within Natural programs. The target language environment determines how 'no date' is handled.

See the notes under data type D in the section *Mapping Software AG IDL Data Types* to the target language environment C | Java | .NET.

5. The data type T has two different meanings:
 - A time-only meaning, which transfers a time without a date. The time-only meaning always uses the invalid date 1.1.000 for the date part. The time part has a value range from 00:00:00.0 to 23:59:59.9. This time-only meaning is not supported.
 - A timestamp meaning, consisting of a date and time.

The supported range is from 1.1.0001 0:00:00.0 up to 31.12.9999 23:59:59.9. Dates BC (before the birth of Christ) are not supported.

It is also possible to transfer 1.1.0000 0:00:00.0 as a value. This is a special value (because there is no year 0) and denotes “no time” is given. The “no time” value is the internal state of a #TIME (Natural type T) variable after a RESET #TIME is executed within Natural programs. The target language environment determines how “no time” is handled.

See the notes under data type T in the section *Mapping Software AG IDL Data Types* to the target language C | Java | .NET.

6. The term *number1[.number2]* describes the number as it is: The first number is the number of digits before the decimal point and the second number is the number of digits after the decimal point. The total number of digits (*number1+number2*) must not exceed 99. Depending on your target programming language, the total number of digits can be more restricted.

If you connect two endpoints, the total number of digits used must be lower or equal than the maxima of both endpoints. For the supported total number of digits for endpoints, see the notes under data types N, NU, P and PU in section *Mapping Software AG IDL Data Types* in the respective Wrapper or language-specific documentation.

7. The length is given in bytes, not in number of characters.
8. The valid integer range is from -128 up to +127.

9. The valid integer range is from -32768 up to +32767.
10. The valid integer range is from -2147483648 up to +2147483647.
11. The following term restricts the valid range which can be transferred from -n.nnnnnn+Enn up to +n.nnnnnn+Enn. A mantissa of 7 decimal digits and an exponent of 2 decimal digits.
12. The following term restricts the valid range which can be transferred from -n.nnnnnnnnnnnnnnn+Enn up to +n.nnnnnnnnnnnnnnn+Enn. A mantissa of 16 decimal digits and an exponent of 2 decimal digits.
13. Valid values are TRUE and FALSE.
14. The length is given in bytes.
15. When using floating-point values, rounding errors can occur when converting to the target language environment. Thus, values from sender and receiver might differ slightly.
16. In environments where multibyte, double-byte or other complex codepages are used, alphanumeric data may increase or decrease during conversion. Thus, to match the field length restriction given by the IDL types A and AV with maximum length, data must be truncated, otherwise unpredictable results will occur. The most popular internationalization approach *ICU Conversion* with `CONVERSION=SAGTRPC` takes care of data increase/decrease.

We recommend always using SAGTRPC for RPC data streams. *Conversion with Multibyte, Double-byte and other Complex Codepages* will always be correct, and *Conversion with Single-byte Codepages* is also efficient because SAGTRPC detects single-byte codepages automatically. See *Conversion Details*.

See also *Configuring ICU Conversion* under *Configuring Broker for Internationalization* in the platform-specific Administration documentation.

17. In environments that use EBCDIC stateful codepages, encoded with escape technique (SI/SO bytes), and where the most popular internationalization approach *ICU Conversion* with `CONVERSION=SAGTRPC` is used, the IDL types K and KV fields allow you to transfer double-byte data without SO and SI bytes. This feature is designed for use in Asian countries. For more information see *Conversion with Multibyte, Double-byte and other Complex Codepages*.
18. The length is given in 2-byte Unicode code units following the Unicode standard. UTF-16. The maximum length is restricted to 805306367 2-byte code units.

Depending on your target environment and target programming language, the mapping may follow a different Unicode standard, for example UTF-32.
19. If *SAGTRPC User Exit* is used as the internationalization approach, the handling of the different IDL types depends on the implementation of the SAGTRPC user exit. This is your responsibility as user. See *Writing SAGTRPC User Exits* in the platform-specific Administration documentation.
20. Variable-length (e.g. AV, AV n) fields are transferred in the RPC data stream in the length specified. A defined maximum in the IDL file limits the number of elements that can be transferred.

Variable-length fields with maximum (e.g. AV_n) are important for connections to endpoints that have no concept of variable-length data, such as COBOL (see *Software AG IDL to COBOL Mapping*) and PL/I (see *Software AG IDL to PL/I Mapping*).

Fixed and Unbounded Arrays

A fixed array is transferred in the RPC data stream with all its elements.

With an unbounded array, the current number of elements and their contents are transferred in the RPC data stream. A defined maximum in the IDL file limits the number of elements that can be transferred.

For the formal syntax of arrays, refer to *array-definition* under *Software AG IDL Grammar*.

Unbounded arrays with a maximum are important for connections to COBOL, which supports a similar concept with the OCCURS DEPENDING ON clause. See *COBOL Tables with Variable Size - DEPENDING ON Clause* under *COBOL to IDL Mapping*.

Rules for Coding IDL Files

1. Statements and their lexical entities can begin in any column and are separated by any number of whitespace characters: blank, new line carriage return, horizontal tab, and form feed.
2. The maximum line length allowed in an IDL file is 256 characters.
3. Comments can be entered in the following ways:
 - If the entire line is to be used for a user comment, enter an asterisk or a slash and an asterisk in columns 1 and 2 of the line:

```
*   USER COMMENT
/*  USER COMMENT
```

- If only the latter part of a line is to be used for a user comment, enter an asterisk or slash asterisk.

```
1 NAME   (A20)   * USER COMMENT
1 NUMBER (A15)  /* USER COMMENT
```

Rules for Coding Group and Parameter Names

Group and parameter names

1. can be defined with the following characters:

- characters: a to z
- characters: A to Z
- digits: 0 to 9 (a digit must not be the first character)
- special characters: - _ \$ # & @ + /

other characters are not allowed.

2. are limited to a maximum length of 31 characters
3. are not allowed to be the same as a valid type-length specification.

For example:

```
1 P1 (P1) In Out
```

is invalid and will cause an error because the name P1 is identical to the type-length P1.

4. must adhere to the rules of the target programming language, for example to permitted special characters or reserved keywords.
5. cannot be defined as the following reserved names:

```
ALIGNED, CALLNAT, DATA, DEFINE, END-DEFINE, IMS, IN, INOUT, IS, LIBRARY, OUT, PARAMETER,
PROGRAM, RCODE, STRUCT, VERSION.
```

6. must be unique and must not conflict with those of the target programming language, see the following portion of an IDL file

```
Define Data Parameter
1 AA (I2)
1 AA (I4)
1 long (I4)
End-define
```

and the output generated with the client.tpl as the template for target language C:

```
short int AA;  
long     AA;      /*erroneous, double declaration*/  
long     long;   /*erroneous, double declaration*/
```

The ambiguous declaration of `AA` and `long` is passed unchecked and the stub will be generated. As you can see, this is not valid C syntax.

Rules for Coding Library, Library Alias, Program, Program Alias and Structure Names

The following rules apply to library, library alias, program, program alias and structure names:

1. Names are restricted by length. Library, library alias, program and program alias are restricted to a maximum length of 128 characters. A structure name is restricted to a maximum length of 31 characters.
2. Names must adhere to the rules of the target programming language, for example regarding permitted special characters or reserved keywords.
3. Names should not start with the prefix "SAG". The prefix "SAG" is used within the delivered IDL files. See *Change RPC Password by Wrappers and RPC Clients* and *Command and Info Services IDLs* for more information.
4. Names must be unique and different within the IDL file after conversion of the name to lowercase or uppercase characters. You cannot use the same name for a library, library alias, program, program alias and structure.

Example: The following names are not allowed within an IDL file:

- MYLIBRARY and MyLibrary
- CALC and Calc
- MYSTRUCTURE and mystructure

Context Menu

The context menu for IDL files in the EntireX Workbench has the most commonly used target environments - COBOL, Integration Server, Natural and Web Services - on the first menu level. Under **Other** you can specify additional supported targets such as C or Java, start the IDL Tester or refactor the IDL file. See example for COBOL below:

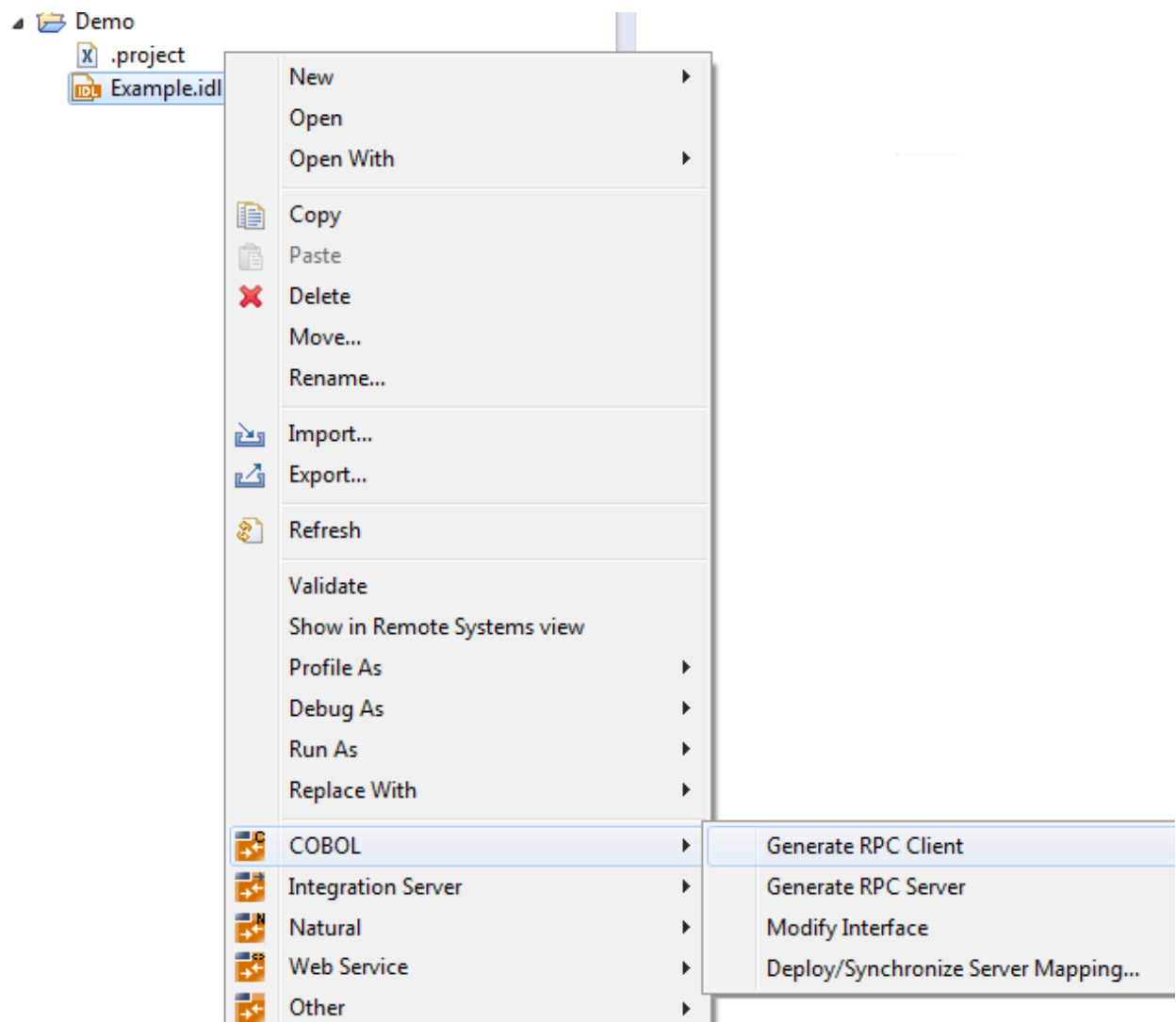

5 Software AG IDL Grammar

▪ Meta Definitions	38
▪ Syntax of the IDL File	39
▪ library-definition	39
▪ program-definition	41
▪ structure-definition	42
▪ parameter-data-definition	43
▪ simple-parameter-definition	45
▪ group-parameter-definition	46
▪ structure-parameter-definition (IDL)	47
▪ array-definition	48
▪ attribute-list	53

A Software AG IDL file contains definitions of the interface between client and server. The IDL file is used by Software AG wrappers to generate RPC clients, RPC servers and tester etc. on the basis of these definitions. The IDL file can be edited by the IDL Editor provided by plug-ins for Eclipse.

This chapter explains the syntax of IDL files in a formal notation. A more descriptive introduction to IDL files is given in the chapter *Software AG IDL File* in the IDL Editor documentation. This chapter covers the following topics:

Meta Definitions

The following metasymbols are used to define the IDL:

- The metasymbols [and] surround optional lexical entities.
- The metasymbols { and } surround optional lexical entities which may be repeated a number of times.
- The metasymbol ::= separates the lexical entity to be defined (on the left) from the definition (on the right).
- The metasymbol | separates lexical entities on the definition side (on the right) meaning all terms are valid to define the lexical entity to be defined (on the left).

The following basic terms are used to describe the IDL:

- The informal term `number` is a sequence of numeric digits e.g. 123.
- The informal term `string` is a sequence of characters. It can contain any character except enclosing apostrophes.

Examples are: 'DARMSTADT' '#FRANKFURT' '&MUNICH'.

- Any terms in uppercase, special characters such as apostrophe, colon (other than the metasymbols above) are terminal lexical entities and must be entered as is.
- The term `identifier` is a sequence of
 - characters: a to z
 - characters: A to Z
 - digits: 0 to 9 (a digit must not be the first character)
 - special characters: - _ \$ # & @ + /

Syntax of the IDL File

Syntax

Software AG IDL	::= library-definition { library-definition }
-----------------	---

Description

- The IDL may contain any number of `library-definition`s.
- One `library-definition` must be contained in an IDL file.

library-definition

A `library-definition` is the grouping of servers (remote procedures).

Syntax

<code>library-definition</code>	::= LIBRARY 'library-name' [:'library-alias'] IS { interface }
<code>library-name</code>	::= string
<code>library-alias</code>	::= string
<code>interface</code>	::= program-definition structure-definition

Description

<code>library-definition</code>	A <code>library-definition</code> is valid until the next <code>library-definition</code> or end of file.
<code>library-name</code>	<ul style="list-style-type: none"> ■ The <code>library-name</code> is used to generate RPC components. How this takes place (e.g. to form a source file name, class name etc.) depends on the target programming language. The wrappers will adapt the <code>library-name</code> to the requirements of the target programming language when special characters occur in the <code>library-name</code>. See <i>Mapping Library Name and Alias</i> in the respective Wrapper documentation. ■ The <code>library-name</code> is also sent (without modifying any special characters) from the RPC client component to the RPC server. In the RPC server the <code>library-name</code> may be used to locate the target server. See <i>Locating and Calling the Target Server</i> in the platform-specific administration or RPC server documentation.

	<ul style="list-style-type: none"> ■ Certain rules apply to <code>library-name</code>. See Rules for Coding Library, Library Alias, Program, Program Alias and Structure Names.
<code>library-alias</code>	<ul style="list-style-type: none"> ■ Alias of the <code>library-name</code>. ■ The purpose of an alias is to allow a different name on the RPC client side from the name on the RPC server side. This is helpful when integrating a system with a short name (e.g. CICS, z/OS, Natural, where up to 8 characters are allowed, or IBM i, where up to 10 characters are allowed) on one side and on the other side an environment with fewer restrictions (UNIX, Windows, Java). ■ The <code>library-alias</code> may be used as a name in the target programming language to form the generated RPC client and RPC server components instead of the <code>library-name</code>. How the <code>library-alias</code> is used to generate components (e.g. to form a source file name, class name etc.) depends on the target programming language. See <i>Mapping Library Name and Alias</i> in the respective Wrapper documentation. ■ The <code>library-alias</code> is always used as is (it is not adapted by the IDL Editor and the Workbench wrappers when special characters occur within the <code>library-alias</code> as it is for the <code>library-name</code>), i.e. the user is responsible for a valid target programming language name. ■ The <code>library-alias</code> is not sent to the target RPC server. The <code>library-name</code> is always sent instead. ■ Certain rules apply to <code>library-name</code>. See Rules for Coding Library, Library Alias, Program, Program Alias and Structure Names.
<code>interface</code>	<ul style="list-style-type: none"> ■ A program-definition or structure-definition concludes the <code>library-definition</code>. ■ Any number of program-definitions or structure-definitions can be embedded in a <code>library-definition</code>.

Example (without alias usage)

```
Library 'ServerLibrary' Is ..
```

Example (with alias usage)

```
Library 'ServerLibrary': 'AliasServerLibrary' Is ..
```

program-definition

A `program-definition` describes the parameters of servers (remote procedures).

Syntax

<code>program-definition</code>	<code>::= PROGRAM 'program-name' [:'program-alias'] IS parameter-data-definition</code>
<code>program-name</code>	<code>::= string</code>
<code>program-alias</code>	<code>::= string</code>

Description

<code>program-definition</code>	<ul style="list-style-type: none"> ■ A <code>program-definition</code> is valid until the next <code>program-definition</code>, <code>structure-definition</code>, <code>library-definition</code> or end of file. ■ Any <code>program-definition</code> must be embedded in a <code>library-definition</code>. ■ Any number of <code>program-definitions</code> can be embedded in a <code>library-definition</code>. ■ One <code>parameter-data-definition</code> must conclude the <code>program-definition</code>.
<code>program-name</code>	<ul style="list-style-type: none"> ■ The <code>program-name</code> is used to generate RPC components. How this takes place (e.g. how to form a source file name, method, function or program name etc.) depends on the target programming language. The IDL Editor and the integrated Workbench wrappers will adapt the <code>program-name</code> to the requirements of the target programming language when special characters occur in the <code>program-name</code>. See <i>Mapping Program Name and Alias</i> in the respective Wrapper documentation. ■ The <code>program-name</code> is also sent (without modifying any special characters) from the RPC client component to the RPC server. In the RPC server the <code>program-name</code> is used to locate the target server. See <i>Locating and Calling the Target Server</i> in the platform-specific administration or RPC server documentation. ■ Certain rules apply to <code>program-name</code>. See Rules for Coding Library, Library Alias, Program, Program Alias and Structure Names.
<code>program-alias</code>	<ul style="list-style-type: none"> ■ Alias of the <code>program-name</code>. ■ The purpose of an alias is to allow a different name on the RPC client side from the name on the RPC server side. This is helpful when integrating a system with a short name (e.g. CICS, z/OS, Natural, where up to 8 characters are allowed, or

	<p>IBM i, where up to 10 characters are allowed) on one side and on the other side an environment with fewer restrictions (Window, UNIX, Java).</p> <ul style="list-style-type: none"> ■ The <code>program-alias</code> may be used as a name in the target programming language to form the generated RPC client and RPC server components instead of the <code>program-name</code>. How the <code>program-alias</code> is used to generate components (e.g. to form a source file name, method, function or program name etc.) depends on the target programming language. <p>See <i>Mapping Program Name and Alias</i> in the respective Wrapper documentation.</p> <ul style="list-style-type: none"> ■ The <code>program-alias</code> is always used as is (it is not adapted by the IDL Editor and the wrappers when special characters occur within the <code>program-alias</code> as it is for the <code>program-name</code>), i.e. the user is responsible for a valid target programming language name. ■ The <code>program-alias</code> is not sent to the target server. The <code>program-name</code> is always sent instead. ■ Certain rules apply to <code>program-alias</code>. See Rules for Coding Library, Library Alias, Program, Program Alias and Structure Names.
--	--

Example (without alias usage):

```
Library 'ServerLibrary' Is
  Program 'ServerName' Is ..
```

Example (with alias usage):

```
Library 'ServerLibrary': 'AliasServerLibrary' Is
  Program 'ServerName' : 'AliasServerName' Is ..
```

structure-definition

A `structure-definition` describes a user-defined type for reusability, referenced in a [structure-parameter-definition \(IDL\)](#).

Syntax

structure-definition	::= STRUCT 'structure-name' IS parameter-data-definition
structure-name	::= string

Description

structure-definition	<ul style="list-style-type: none"> ■ A structure-definition is valid until the next program-definition, structure-definition, library-definition or end of file. ■ Any structure-definition must be embedded in a library-definition. ■ Any number of structure-definitions can be embedded in a library-definition. ■ One parameter-data-definition must conclude the structure-definition. ■ Structures are mapped to various concepts depending on the target programming language. See <i>Mapping Structures</i> in the respective Wrapper documentation.
structure-name	<ul style="list-style-type: none"> ■ The structure-name used for reference. ■ Certain rules apply to structure-name. See Rules for Coding Library, Library Alias, Program, Program Alias and Structure Names.

Example

```
Library 'ServerLibrary': 'AliasServerLibrary' Is
Struct 'Person' Is ..
```

parameter-data-definition

The parameter-data-definition describes the parameters of a server when it is embedded in a program-definition. It describes a user-defined type when it is embedded in a structure-definition.

Syntax

parameter-data-definition	<pre> ::= DEFINE DATA PARAMETER simple-parameter-definition group-parameter-definition structure-parameter-definition { simple-parameter-definition group-parameter-definition structure-parameter-definition } END-DEFINE</pre>
---------------------------	--

Description

parameter-data-definition	<ul style="list-style-type: none"> ■ The parameter-data-definition consists of a starting token sequence (Define Data Parameter) and an ending token sequence (End-Define). ■ Any number of simple-parameter-definition, group-parameter-definition and structure-parameter-definition can be embedded in a parameter-data-definition. ■ At least one simple-parameter-definition, group-parameter-definition or structure-parameter-definition must exist (at level 1) without the <i>attribute-list</i>. ■ The parameter-data-definition must conclude the corresponding program-definition or structure-definition. ■ There can only be one parameter-data-definition for each program-definition or structure-definition.
---------------------------	--

Example of a Program:

```
Library 'ServerLibrary' Is
  Program 'ServerName' Is ..
    Define Data Parameter
    ...
  End-Define
```

Example of a Structure:

```
Library 'ServerLibrary': 'AliasServerLibrary' Is
  Struct 'Person' Is ..
    Define Data Parameter
    ...
  End-Define
```

simple-parameter-definition

The construct `simple-parameter-definition` describes the syntax of a simple parameter, i.e. not a group (groups are described in a `group-parameter-definition`), not a reference to a structure (referencing a structure is described in [structure-parameter-definition \(IDL\)](#)).

Syntax

<code>simple-parameter-definition</code>	<code>::= level parameter-name (type-length[/array-definition]) [attribute-list]</code>
<code>level</code>	<code>::= number</code>
<code>parameter-name</code>	<code>::= identifier</code>
<code>type-length</code>	See IDL Data Types .

Description

<code>level</code>	<ul style="list-style-type: none"> ■ Level number is a 1 or 2-digit number in the range from 01 to 99 (the leading 0 is optional) used in conjunction with parameter grouping. ■ Parameters assigned a level number of 02 or greater are considered to be members of the immediately preceding group that has been assigned a lower level number. ■ Do not skip level numbers when assigning the level numbers for group members.
<code>parameter-name</code>	<ul style="list-style-type: none"> ■ The name of the parameter. The <code>parameter-name</code> is used as name in the target programming language. It is adapted by the IDL Editor and the wrappers to the requirements of the target programming language. <p style="margin-left: 20px;">See <i>Mapping Parameter Names</i> in the respective Wrapper documentation.</p> <ul style="list-style-type: none"> ■ Certain rules apply to <code>parameter-name</code>. See Rules for Coding Group and Parameter Names.
<code>type-length</code>	The type and length of the parameter. See IDL Data Types .

Example

```

...
1 PERSON-ID (N10)
1 PERSON-NAME (A100)
...

```

group-parameter-definition

The construct `group-parameter-definition` describes the syntax of a group.

Syntax

<code>group-parameter-definition</code>	<code>::= level group-name [(/array-definition)] [attribute-list]</code>
<code>level</code>	<code>::= number</code>
<code>group-name</code>	<code>::= identifier</code>

Description

<code>level</code>	See simple-parameter-definition .
<code>group-name</code>	<ul style="list-style-type: none"> ■ The name of the group. ■ The definition of a group enables references to a series of parameters (can also be only 1 parameter) by using the group name. This provides a convenient and efficient method of referencing a series of consecutive parameters. ■ A group may contain other groups, structures (<code>structure-parameter-definition</code>) or parameters (<code>simple-parameter-definition</code>) as group members. ■ Certain rules apply to <code>group-name</code>. See Rules for Coding Group and Parameter Names. ■ Groups are mapped to various concepts depending on the target programming language. See <i>Mapping Groups and Periodic Groups</i> in the respective Wrapper documentation.

Example

```
...
1 PERSON /* this is the group */
2 PERSON-ID (N10) /* this is a group member */
2 PERSON-NAME (A100) /* this is also a group member */
...
```

structure-parameter-definition (IDL)

The construct `structure-parameter-definition` describes the syntax of a reference to a structure.

Syntax

<code>structure-parameter-definition</code>	<code>::= level parameter-name (structure-reference[/array-definition]) [attribute-list]</code>
<code>level</code>	<code>::= number</code>
<code>parameter-name</code>	<code>::= identifier</code>
<code>structure-reference</code>	<code>::= 'structure-name'</code>

Description

<code>level</code>	See simple-parameter-definition .
<code>parameter-name</code>	See simple-parameter-definition .
<code>structure-reference</code>	<ul style="list-style-type: none"> ■ <code>structure-name</code> of the referenced structure. ■ The referenced <code>structure-name</code> must be surrounded by quotation marks. ■ Structures are mapped to various concepts depending on the target programming language. See <i>Mapping Structures</i> in the respective Wrapper documentation. ■ Certain rules apply to <code>structure-name</code>. See Rules for Coding Library, Library Alias, Program, Program Alias and Structure Names.

Example

```

STRUCT 'Person' Is /* this defines the structure person */
Define Data Parameter
1 PERSON
2 PERSON-ID (N10)
2 PERSON-NAME (A100)
End-Define
...
1 FATHER ('Person') /* this references the structure */
1 MOTHER ('Person') /* this references the structure */
1 CHILDS ('Person'/10) /* this references the structure */
...

```

array-definition

Arrays can have either fixed upper bounds or variable upper bounds, so-called unbounded arrays.

Syntax

array-definition	::= fixed-bound-array unbounded-array
fixed-bound-array	::= [fixed-bound-array-index [,fixed-bound-array-index [,fixed-bound-array-index]]]
unbounded-array	::= [unbounded-array-index [,unbounded-array-index [,unbounded-array-index]]]
fixed-bound-array-index	::= [lower-bound:] upper-bound
unbounded-array-index	::= [1:] V[maximum-upper-bound]
lower-bound	::= number
upper-bound	::= number
maximum-upper-bound	::= number

Description

array-definition	<ul style="list-style-type: none"> ■ Arrays with a fixed size of elements are fixed bound arrays. ■ Arrays with a variable number of elements are so called unbounded arrays. ■ Arrays are one, two or three-dimensional.
fixed-bound-array	<ul style="list-style-type: none"> ■ Almost all programming languages have a concept of arrays with a fixed size of elements. ■ See <i>Mapping Fixed and Unbounded Arrays</i> in the respective Wrapper documentation.

unbounded-array	<ul style="list-style-type: none"> ■ Unbounded arrays are not supported by all endpoints, or are supported with restrictions. ■ See <i>Mapping Fixed and Unbounded Arrays</i> in the respective Wrapper documentation.
fixed-bound-array-index	<ul style="list-style-type: none"> ■ If an array-index is of the format [lower-bound:]upper-bound it describes an array with fixed bounds. ■ The fixed number of occurrences is calculated as upper-bound - lower-bound + 1.
unbounded-array-index	<ul style="list-style-type: none"> ■ If maximum-upper-bound is given, the variable number of occurrences (elements) can vary between 0 (empty unbounded array) and maximum-upper-bound. ■ If no maximum-upper-bound is given, there is no practical upper limit on the variable number of occurrences.⁽¹⁾ ■ Empty unbounded arrays with zero number of occurrences are always possible. The optional notation [1:] is ignored and has no effect. <p>Note: ⁽¹⁾ The implementation limits the number to 2,147,483,647 elements.</p> <ul style="list-style-type: none"> ■ If an array-index is of the format [1:]V[maximum-upper-bound] it describes an unbounded array with variable bounds.
lower-bound	<ul style="list-style-type: none"> ■ The lower-bound value is optional. ■ If the lower-bound is not given, the default is 1.
upper-bound	<ul style="list-style-type: none"> ■ The upper-bound value must be entered. ■ The upper-bound value must be greater than or equal to the lower-bound.
maximum-upper-bound	<ul style="list-style-type: none"> ■ The maximum-upper-bound value is optional. ■ It defines a limit which cannot be exceeded.

Example of Arrays with Fixed Bounds

```

...
1 NAMES (A100/10) /* 1 dimensional array */
1 TUPLES (A100/10,10) /* 2 dimensional array */
1 TRIPLES (I1/1:20,1:20,1:20) /* 3 dimensional array */
...

```

Example of Arrays with Variable Upper-bounds

```
...  
1 NAMES (A100/V) /* 1 dimensional array */  
1 TUPLES (A100/V,V) /* 2 dimensional array */  
1 TRIPLES (I1/1:V,1:V,1:V) /* 3 dimensional array */  
...
```

Example of Arrays with Variable Upper-bounds and Maximum

```
...  
1 NAMES (A100/V10) /* 1 dimensional array */  
1 TUPLES (A100/V10,V10) /* 2 dimensional array */  
1 TRIPLES (I1/1:V20,1:V20,1:V20) /* 3 dimensional array */  
...
```



Caution: Mixed arrays with fixed upper bounds and variable upper bounds are not supported.

(I2/1:V,20,V) is not permitted.

(I2/V10,30) is not permitted.

Mixed arrays with variable upper bounds with maximum and without maximum are not supported.

(I2/V10,V20,V) is not permitted.

Three-dimensional Array with Fixed Bounds

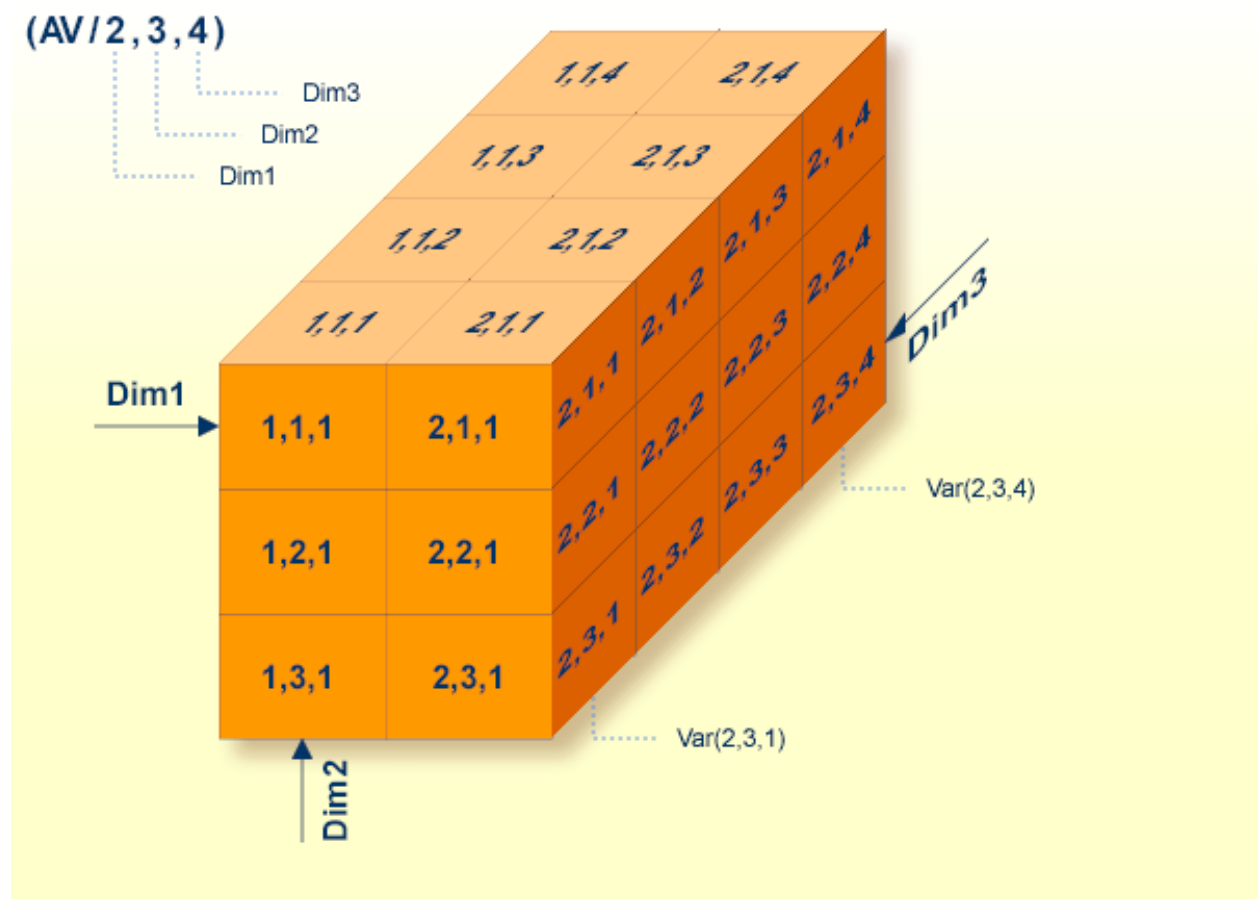

Three-dimensional Array with Variable Upper Bounds

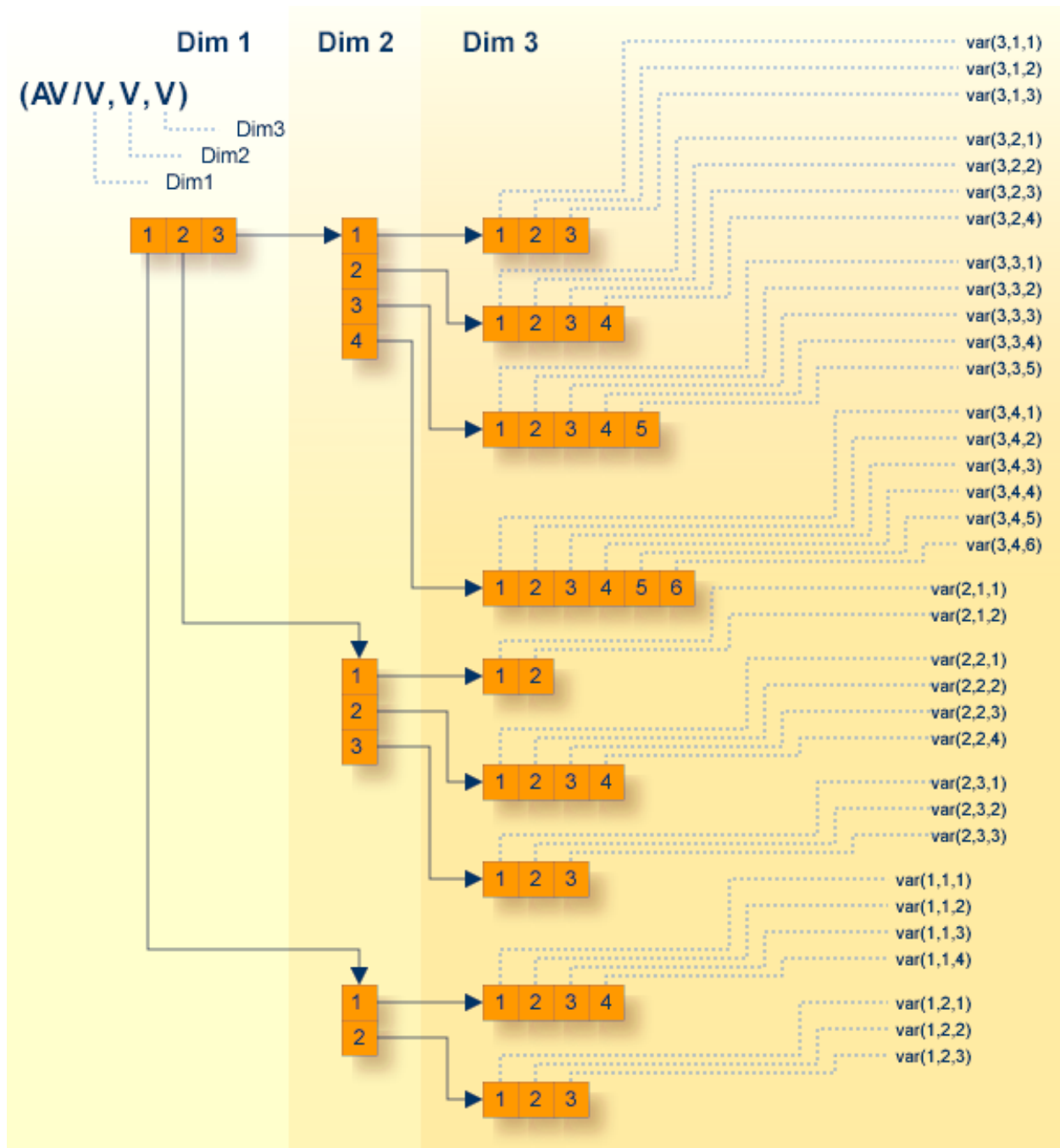

In the illustration above, the vectors of the second dimension have different lengths. The first vector has a length of 4, the second a length of 3 and the third a length of 2. The same is true for the third dimension with vector length of (3,4,5,6) (2,4,3) and (4,3).



Note: This type of unbounded array is not possible if you are using COBOL as the endpoint. In COBOL, all vectors in a dimension have the same length. A 2-dimensional array forms a rectangle and a 3-dimensional array forms a cuboid.

- For the *COBOL Wrapper*, see *Mapping Fixed and Unbounded Arrays*.
- For the *IDL Extractor for COBOL*, see *COBOL Tables with Variable Size - DEPENDING ON Clause*.

attribute-list

Attributes describe further parameter properties to correctly map the parameter to the target platform or to optimize the parameter transfer.

Syntax

attribute-list	::= [aligned-attribute] [direction-attribute] [ims-attribute] [choice-attribute]
aligned-attribute	::= ALIGNED
direction-attribute	::= IN OUT IN OUT INOUT
ims-attribute	::= IMS
choice-attribute	::= CHOICE

Description

aligned-attribute	<ul style="list-style-type: none"> ■ The aligned attribute (mainly) belongs to the server and describes a different alignment from the compiler's default of the server interface. ■ The aligned attribute is relevant for the programming languages COBOL and PL/I in the RPC server environments batch, CICS and IMS. ■ Programming languages other than COBOL and PL/I do not consider it in the interface of the generated servers. ■ RPC Clients send the aligned attribute within the RPC data stream to the RPC server, where it is considered (the related parameter is aligned) by the RPC server, if relevant. ■ See <i>Mapping the aligned Attribute</i> in the respective Wrapper documentation for information on whether your client environment supports sending aligned attributes.
direction-attribute	<p>The direction attribute optimizes parameter transfer.</p> <ul style="list-style-type: none"> ■ In data is passed from client to server. ■ Out data is passed from server to client.

	<ul style="list-style-type: none"> ■ In Out data is passed in both directions. ■ The direction of group members is inherited from the parent group. Thus only the direction information of the top-level fields (level 1) is relevant. Group fields always inherit the specification from their parent. ■ A different specification given with the group members is ignored. ■ The direction of members of a <code>structure-definition</code> is inherited from the <code>structure-parameter-definition</code>. Thus only the direction information of the <code>structure-parameter-definition</code> (structure reference) is relevant. Structure fields always inherit the specification from their reference. ■ A different specification given with the structure members is ignored. ■ When no direction is specified, In Out is used as the default. ■ See <i>Mapping the Direction Attributes In, Out, InOut</i> in the respective Wrapper documentation.
<code>ims-attribute</code>	<p>The <code>ims-attribute</code> marks PCB (Program Communication Block) parameters for the target platform IMS (IBM's Information Management System).</p> <ul style="list-style-type: none"> ■ The <code>ims-attributes</code> are considered when servers for the target platform IMS are generated with the COBOL Wrapper and the PL/I Wrapper. ■ The <code>ims-attributes</code> are obsolete for clients and other wrappers than COBOL and PL/I and are ignored. ■ The <code>ims-attribute</code> is only relevant on top-level fields (level 1). Group fields always inherit the specification from their parent, thus a different specification is ignored.
<code>choice-attribute</code>	<p>The <code>choice-attribute</code> marks a <i>group-parameter-definition</i> as the surrounding container for multiple possible output (MPO) structures. This kind of IDL syntax is retrieved when extracting, for example, from a <i>REDEFINES Clause</i>. See also Mapping Editor IDL Interface mapping function <i>Set Multiple Possible Output (MPO) Structures</i> for interface type DFHCOMMAREA (In same as Out, In different to Out) Large Buffer (In same as Out, In different to Out) Channel Container IMS Connect.</p>

Example of aligned-attribute

```
1 PERSON_ID (NU12) ALIGNED
```

Example of direction-attribute

```

...
1 PERSON_ID (NU12) IN
1 PERSON_NAME (A100) OUT
...

```

Example of ims-attribute

```

...
1 PERSON_ID          (NU12)  IN OUT
1 PERSON_NAME       (A100)  IN OUT
1 DBPCB              IMS
  2 DBNAME           (A8)
  2 SEG-LEVEL-NO     (A2)
  2 DBSTATUS         (A2)
  2 FILLER           (A20)
...

```

Example of choice-attribute

```

...
1 OUTPUT              Out
  2 PAYMENT-TYPE      (A2)
  2 PAYMENT-DATA-MPO  Choice
    3 PAYMENT-DATA    (/V1)
      4 PAYMENT-DATA  (AV256)
    3 PAYMENT-DATA-VOUCHER (/V1)
      4 VOUCHER-ORIGIN (AV128)
      4 VOUCHER-SERIES (AV128)
    3 PAYMENT-DATA-CREDITCARD (/V1)
      4 CREDITCARD-NUMBER (NU18)
      4 CREDITCARD-CODE  (NU12)
      4 CREDITCARD-VALIDITY (AV8)
...

```

6 The Software AG IDL Compiler

- Introduction 58
- Starting the IDL Compiler 58
- IDL Compiler Usage Examples 60
- Writing your own Wrappers and Stubs 60

The Software AG IDL Compiler generates interface objects, skeletons and wrappers. It uses a Software AG IDL file and a template file that controls the generated output.

Introduction

The IDL Compiler is used to generate stubs, skeletons and wrappers from two specific input files:

- the IDL file (extension `.idl`), which describes the interface between client and server.
- the template file (extension `.tpl`), which controls the generated output files and their contents. In principle the template describes the target programming language.

The IDL Compiler first reads through the IDL file and builds tables and structures that form an internal representation of the interface. If there is a related server mapping file, it is also read implicitly (see *Server Mapping Files for Natural*). The IDL Compiler then loops through this internal representation and uses the template file to generate its output, the source code for the target programming language.

The following wrappers use the IDL Compiler as their generation tool:

- *EntireX DCOM Wrapper*
- *EntireX C Wrapper*
- *EntireX .NET Wrapper*
- *EntireX COBOL Wrapper*
- *EntireX PL/I Wrapper*

The IDL Compiler and the template files for the target programming languages above are fully integrated in the *EntireX Workbench*. For automation purposes, the IDL Compiler can also be started at the command prompt.

Starting the IDL Compiler

➤ To start the IDL Compiler

- At a command prompt, enter

```

Java -classpath "%ProgramFiles%\software
ag\entirex\classes\exxidlcompiler.jar;%ProgramFiles%\software
ag\entirex\classes\saglic.jar" "-Dsagcommon=%CommonProgramFiles%\Software AG"
com/softwareag/entirex/idlcompiler/TplParser -t template file [-Doption=value]
[-Fbasename] [-Ppreprocessor variable] [-ooutput-directory] [-Ttrace-level]
[-deprecated] -idl idlfile.idl

```

Parameter	Description										
-help	Displays help using the command-line options.										
-D <i>option=value</i>	Passes the option to the templates. See also Using Options .										
-F <i>basename</i>	Indicates that the output file base name follows. It is used as given - thus it should be provided without a path and extension. Only relevant if supported by the template used. Default is the base name of the <i>idl-file</i> without path and extension. See Specifying the Name of the Output File .										
-t <i>template</i>	Name of the initial template file.										
-P <i>preprocessor variable</i>	Specifies a preprocessor variable that can be controlled in template files with <code>#ifdef</code> , <code>#elif</code> , <code>#else</code> , and be closed by <code>#endif</code> . Only relevant if supported by the template used. See Using Template #if Preprocessing Statements .										
-o <i>output-directory</i>	Specifies the directory for the output file. See Specifying the Name of the Output File .										
-T <i>trace-level</i>	Trace information is entered as comment lines into the generated output. <table border="1"> <thead> <tr> <th>Trace level</th> <th>Description</th> </tr> </thead> <tbody> <tr> <td>0</td> <td>No trace output will be created. This is the default trace level.</td> </tr> <tr> <td>1</td> <td>Generates only template file name and the line number in the output file. This trace level helps to identify the specific line in the template file.</td> </tr> <tr> <td>2</td> <td>This is the full tracing mode for the template file. Every action of the IDL Compiler will be displayed.</td> </tr> <tr> <td>3</td> <td>Additional traces for preparation of the output statement will be created.</td> </tr> </tbody> </table>	Trace level	Description	0	No trace output will be created. This is the default trace level.	1	Generates only template file name and the line number in the output file. This trace level helps to identify the specific line in the template file.	2	This is the full tracing mode for the template file. Every action of the IDL Compiler will be displayed.	3	Additional traces for preparation of the output statement will be created.
Trace level	Description										
0	No trace output will be created. This is the default trace level.										
1	Generates only template file name and the line number in the output file. This trace level helps to identify the specific line in the template file.										
2	This is the full tracing mode for the template file. Every action of the IDL Compiler will be displayed.										
3	Additional traces for preparation of the output statement will be created.										
-deprecated	Deprecated mode allows compilation of templates for statements already deprecated. Each deprecated statement will create a warning.										
-idl <i>idl-file</i>	Name of the IDL file. Multiple IDL files can be provided.										

IDL Compiler Usage Examples

Calling the IDL Compiler under UNIX

The following applies to the UNIX Bourne, Korn and C shell.

```
$JAVA_HOME/java -Dstagcommon=<Install_Dir>/EntireX\common\conf -Dentirex.home=$EXXDIR  
-classpath $EXXDIR/classes/exxidlcompiler.jar:$EXXDIR/classes/saglic.jar  
com/softwareag/entirex/idlcompiler/TplParser -t $EXXDIR/template/client.tpl -idl  
aaclient.idl
```

An *erxidl.bsh* shell script file is provided with a preconfigured invocation of the IDL Compiler. In addition, the "-deprecated" mode is set as default in this shell script file.

```
erxidl.bsh -t ...\EntireX\template\client.tpl -idl aaclient.idl
```

Calling the IDL Compiler under Windows

```
java -classpath "%ProgramFiles%\software  
ag\entirex\classes\exxidlcompiler.jar;%ProgramFiles%\software  
ag\entirex\classes\saglic.jar" "-Dstagcommon=%CommonProgramFiles%\Software AG"  
com/softwareag/entirex/idlcompiler/TplParser -t ...\EntireX\template\client.tpl  
-idl aaclient.idl
```

An *erxidl.bat* batch file for the Windows command shell is provided with a preconfigured invocation of the IDL Compiler. In addition, the "-deprecated" mode is set as default in this batch file.

```
erxidl -t ...\EntireX\template\client.tpl -idl aaclient.idl
```

Writing your own Wrappers and Stubs

Additional programming languages can be adopted with user-written templates (see [Writing Template Files for Software AG IDL Compiler](#)). The syntax for IDL template files in a formal notation is presented in the section [Grammar for IDL Template Files](#).

Integration with the IDL Editor can be accomplished using the plug-in technique provided (see [Using EntireX Custom Wrappers](#)).

7

Writing Template Files for Software AG IDL Compiler

▪ Coding Tempate Files	62
▪ Using Output Statements in the Template File	63
▪ Inserting Comments in the Template File	65
▪ Using Verbatim Mode	66
▪ Using Options	66
▪ Specifying the Name of the Output File	66
▪ Redirecting the Output to Standard Out	67
▪ Using Template #if Preprocessing Statements	68
▪ Using Template #include Preprocessing Statements	70
▪ Using Template #trace Statement	70

An IDL template file contains the rules that the Software AG IDL Compiler uses - together with the IDL file - to generate interface objects, skeletons and wrappers for a programming language. The Developer's Kit provides several templates for various programming languages.



Caution: The information in this section is intended for users who wish to write their own template files. Do not change the delivered template files.

This document provides an introduction on how to write template files. The syntax for IDL Template Files in a formal notation is presented in the document [Grammar for IDL Template Files](#).

Coding Tempate Files

It is the combination of control and output statements (see [control_statement](#), [output_statement](#) and [Using Output Statements in the Template File](#)) that provides the full definition of the target programming-language source code.

Usually a template file has [definition-statement](#) grouped together at the beginning; these are followed by [loop_statements](#):

```
; type definitions
%using A "char %name%index"
....
; loop libraries
%library
{
    ....
    ; loop programs
    %program
    {
        ....
        ; loop parameters
        %name
        {
            ....
        }
    }
}
```

Using Output Statements in the Template File

Output statements (see [output_statement](#)) provide the actual templates of the target-language source code. Output statements are text strings enclosed in double quotes.

These text strings may contain [output_substitution_sequence](#), [output_formatting_sequence](#), [output_escape_sequence](#) and [output_of_variable](#).

Substitution Sequences

Substitution sequences are identified by a preceding % and are substituted by their actual contents during generation.

Example: "This is a text string. The library name is %library. \n"

The IDL Compiler provides substitution sequences for the current library name, program name, parameter name, type, etc. Some substitution sequences can only be accessed in their corresponding loop statement. For example a %program substitution sequence is only valid within an active program loop (see [loop_over_programs](#)). See [output_substitution_sequence](#) for a list of valid substitution sequences and description.

Formatting Sequences

Formatting sequences are identified by a preceding \

Example: "\n is a Formatting sequence"

See [output_formatting_sequence](#) for a list of valid formatting sequences

Escape Sequences

Escape sequences are identified by a preceding \ \

The escape character is used to change the meaning of special characters (&, ? and # etc.) back to their normal meaning. Special characters are used to access variables (see [output_of_variable](#)).

Example: "\\&".

See also [output_escape_sequence](#) and [Using Verbatim Mode](#).

Variables

The output of variables is forced when the special characters `&`, `?` or `#` occur before the variable name (see *variable_name*) in output statements (see *Using Output Statements in the Template File*)

Example: `"?A is the output of a variable"`

See also *output_of_variable*

Generating Programming-language-specific Type Definitions

The substitution sequence `%type` is usually used in a parameter loop (*loop_over_parameters*) to generate programming-language-specific type definitions. Before the parameter loop all IDL data types (with *definition-of-base-type-template* statements) and the dimension information (with *definition-of-index-template* statements) must be specified.

Example

IDL data type I2 can be specified as follows in a C program:

```
%using %index "" "[%1_index]" "[%1_index][%2_index]"
 "[%1_index][%2_index][%3_index]"
%using I2 "short %name%index;"
```

`%using %index` is the *control_statement* for the dimension information (*definition-of-index-template*). How the following strings are used depends on the dimension of the parameter. The first empty string is used for scalar parameters, the second for 1-dimensional parameters, the third for 2-dimensional parameters and the fourth for 3-dimensional parameters.

`%using I2` is the *control_statement* for the IDL data type I2 (see *definition-of-base-type-template*), `"short %name%index"` is the *output_statement* for this data type. `%name` and `%index` are substitution sequences. `%name` will be replaced by the variable name and `%index` will be replaced by any dimension information.

If an input IDL file contained the following parameter definitions:

```
1 Field-1 (I2)
1 Field-2 (I2/1:8)
1 Field-3 (I2/1:4,4:7)
```

then, based on the above template specifications, all references to the `%type` substitution sequences in any *output_statement* would be replaced by

```
short Field_1;
short Field_2[8];
short Field_3[4][4];
```

Generating Programming-language-specific Names

Special characters within some substitution sequences e.g. %library, %program and %name can be changed during generation to provide valid names for the target programming language. The IDL Compiler supports generation of names for the programming languages C, C# and COBOL (see [output_control_lower_upper](#) and [output_control_sanitize](#)).

Target Programming Language	Class Names	Function Names	Variable or Parameter Names
C	not applicable	%UpperCase- %LowerCase+ %Sanitize+	%UpperCase- %LowerCase+ %Sanitize+
C#	%UpperCase- %LowerCase- %SanitizePascalCased+		%UpperCase- %LowerCase- %SanitizeCamelCased+
COBOL	not applicable		%SanitizeCobol+ %UpperCase+ %LowerCase-

The default programming language when you do not code any `output_control_lower_upper` and `output_control_sanitize` statements in your template is C.

Inserting Comments in the Template File

Comments

- are identified by a “;” in a line and
- are terminated by the end of line.

For example:

```
; This is a comment
           ; So is this.
"output text followed by a comment" ; here is the comment
```

Whereas this is an output statement:

```
"an output text with a semicolon ;"
```

Using Verbatim Mode

If your output is going to contain many special characters, you may enter verbatim mode. Then all characters are written to the output as typed. The only sequences recognized in this mode are the escape sequences (see [output_escape_sequence](#)).

> To enter verbatim mode

- Use the command `%verbose+` (see [output_control_verbose](#)).

Example: In verbatim mode, you enter "&" to insert an ampersand.

Using Options

The IDL Compiler supports options within templates.

You can pass them with the parameter `-D` to the IDL Compiler (see [Starting the IDL Compiler](#)).

Options

- can be used in output statements (see [output_of_variable](#))
- can be used in logical condition criteria (see [compare_strings](#)) in `%if` (see [if_statement](#)) and `%while` (see [loop_of_while](#)) statements
- are case-sensitive, i.e. `hugo` and `HUGO` are distinct options

Specifying the Name of the Output File

The name of the output file is controlled by the `%file` statement.

If the `%Format` substitution sequence in a file (`%file`) statement is used, the base name can be provided with the IDL Compiler parameter `-F` (see [Starting the IDL Compiler](#)).

If no base name is provided with the `-F` IDL Compiler parameter, the base name of the IDL file without path and extension is used as the default of the substitution sequence `%Format`.

See the following excerpt from a template file:

```
%file "C%F.c"
```

When the IDL Compiler is called with

```
■ erxidl -t client.tpl .. \MyDirectory\example.idl
```

an output file with the default base name *Cexample.c* of the IDL file is created

```
■ erxidl -t client.tpl -Ftest example.idl
```

an output file with the name *Ctest.c* is created

See also the IDL Compiler option `-o` (see [Starting the IDL Compiler](#)) on how to specify the directory for the output file.

Redirecting the Output to Standard Out

The output can be redirected to standard out with an environment variable (see [Using Options](#)), e.g. `NOOPEN`. This is optional.

See the following excerpt from a template file:

```
%if "$(NOOPEN)" <> "1" %file "C%library.c" ;
```

When the IDL Compiler is called with

```
■ erxidl -t client.tpl -D NOOPEN=1 example.idl
```

the output is redirected to standard out

```
■ erxidl -t client.tpl example.idl
```

the output is directed to the file *Cexample.c* as specified in the template.

Using Template `#if` Preprocessing Statements

The IDL Compiler supports `#ifdef`, `#elif`, `#else` and `#endif` preprocessing statements similar to the C compiler preprocessor.

You can use preprocessor variables with the option `-D` (see [Starting the IDL Compiler](#)).

Additional rules for `#if` preprocessing statements are:

- If `#elif` is used, it must follow `#ifdef`.
- If `#else` is used it must follow either `#ifdef` or `#elif`.
- `#endif` must always close the `#ifdef` statement.
- Embedded preprocessor statements or logical concatenation of definitions are not allowed.

See the following excerpt from a template file:

```
#ifdef Definition_1
    /* codes of -PDefinition_1 */\n"
    %name
    {
    :
    }
#elif Definition_2
    /* codes of -PDefinition_2 */\n"
    %name
    {
    :
    }
#else
    /* codes of neither Definition_1 nor Definition_2 */\n"
    %name
    {
    :
    }
#endif
```

When the IDL Compiler is called with

- `erxidl -t template_file -PDefinition_1`

the template statements `/* codes of -PDefinition_1 */\n"` between the `#ifdef` and first `#elif` statement are interpreted.

```
■ erxidl -t template_file -PDefinition_2
```

the template statements `/* codes of -PDefinition_2 */` between the first `#elif` and second `#elif` statement are interpreted.

```
■ erxidl -t template_file
```

the template statements `/* codes of neither Definition_1 nor Definition_2 */` between the `#else` and `#endif` statement are interpreted.

See the following preprocessing statements with invalid syntax:

```
..  
#ifdef (MY_VERSION) ; brackets are not allowed  
#endif  
#ifdef MY_VERSION || HIS_VERSION ; logical OR is not allowed  
..  
#endif  
#ifdef (MY_VERSION)  
..  
#ifdef (MY_NEW_VERSION) ; embedded #ifdef is not allowed ←
```

Using Template `#include` Preprocessing Statements

The IDL Compiler supports `#include` preprocessing statements similar to the C compiler preprocessor. All statements in the included template file are simply embedded.

To find included template files, use the IDL Compiler option `-I` and add a list of directories that form a search path (see [Starting the IDL Compiler](#)).

- First the IDL Compiler searches for templates in the directory of the initial template.
- When no template is found in the directory of the initial template, all directories specified with `-I` are searched in the order of occurrence

Additional rules for `#include` preprocessing statements are:

- A maximum of 32 templates can be included in a generation process.
- An included template file can include further template files.
- Recursive inclusion of template files is not permitted.
- All variables can be accessed in all included template files as well as in the starting (root) template.

The compiler searches for included templates.

See the following excerpt from a template file:

```
#include "template.tpl"
```

Using Template `#trace` Statement

The IDL Compiler supports the `#tracetracelevel` statement to enable and disable template tracing within a certain block of the template. The usage of `tracelevel` is the same as the command-line option `"-T"`.

See also compiler option `"-T"` under [Starting the IDL Compiler](#) for trace level values.

Example

```
#trace 2 ; enable tracing on trace level 2
%compute i "0"
%while "&i" < "10"
{
  %compute i "&i + 1"
}
#trace 0 ; disable
```

8

Grammar for IDL Template Files

▪ Software AG Template File Grammar	75
▪ assign_statement	75
▪ assign_integer_statement	76
▪ assign_string_statement	76
▪ block	77
▪ compare_expression	77
▪ compare_strings	78
▪ compare_operator	78
▪ control_statement	79
▪ definition-statement	80
▪ definition-of-base-type-template	81
▪ definition-of-base-type	82
▪ definition-of-direction-template	83
▪ definition-of-group-template	83
▪ definition-of-index-template	84
▪ definition-of-line-number-format-template	84
▪ definition-of-member-separator-template	85
▪ definition-of-names-format-template	85
▪ definition-of-OutBlank-template	86
▪ definition-of-nest-level-format-template	86
▪ definition-of-parent-identifier-template	87
▪ definition-of-parent-index-template	87
▪ definition-of-structure-template	88
▪ definition-of-UnboundedArray-template	88
▪ error_statement	89
▪ execute_statement	90
▪ file_handling_statement	91
▪ if_statement	92
▪ if_elif_extension	92
▪ logical_compare_operator	93
▪ loop_statement	93
▪ loop_over_libraries	94

- loop_over_parameters 95
- loop_over_programs 95
- loop_over_structures 96
- loop_of_while 96
- message_statement 97
- output 97
- output_character_sequence 98
- output_control_ims 99
- output_control_imsonly 99
- output_control_lower_upper 100
- output_control_sanitize 101
- output_control_statement 103
- output_control_verbos 104
- output_escape_sequence 104
- output_formatting_sequence 105
- output_of_variable 106
- output_statement 106
- output_substitution_sequence 107
- parameter_list 111
- return_list 111
- return_statement 112
- statement 112
- string 113
- string_with_expression_contents 113
- substring_statement 114
- UnsupportedProgram_statement 115
- variable_index 116
- variable_name 116
- variable_of_type_indexed_string 117
- variable_of_type_integer 117
- variable_of_type_string 118

An IDL template file contains the rules that the Software AG IDL Compiler uses - together with the IDL file - to generate interface objects, skeletons and wrappers for a programming language. The Developer's Kit provides several templates for various programming languages.



Caution: The information in this section is intended for users who wish to write their own template files. Do not change the delivered template files.

This document explains the syntax of the template files in a formal notation. For an introduction on how to write template files, see [Writing Template Files for Software AG IDL Compiler](#).

Software AG Template File Grammar

Syntax

```
{ statement }
```

Description

A template contains the rules which the IDL Compiler uses with the IDL file. The template is the lexical entity to start with.

Example

See under the lexical entity [statement](#).

assign_statement

Syntax

```
assign_string_statement | assign_integer_statement
```

Description

These statements are used

- to assign strings to *variable_of_type_string* and *variable_of_type_indexed_string*,
- to compute values and assign them to *variable_of_type_integer*.

Example

See the lexical entities *assign_string_statement* or *assign_integer_statement*.

assign_integer_statement

Syntax

```
%compute variable_of_type_integer string_with_expression_contents
```

Description

Compute the expression in *string_with_expression_contents* and assign the result to *variable_of_type_integer*.

Example

```
%compute a "&b * (%before + %after) / %eLength"
```

assign_string_statement

Syntax

```
%assign variable_of_type_string string |  
%assign variable_of_type_indexed_string string
```

Description

Assign the string contents to *variable_of_type_string* or *variable_of_type_indexed_string*

Example

```
%assign A "Assign this string to variable A" %assign A[5] "Assign this  
string to occurrence 5 of variable A"
```

block

Syntax

```
'{ ' statement [ block ] '}'
```

Description

A block is a sequence of statements.

Example

See the lexical entity *statement*.

compare_expression

Syntax

```
compare_strings [logical_compare_operator compare_strings]
```

Description

The *logical_compare_operator* performs a logical operation of two *compare_strings*. See the description of *logical_compare_operator* and *compare_strings* for specific information.

Example

```
%if "&i" > "3" && "&k" < "20"  
{  
"the variable i is greater than three AND the variable k is less than twenty"  
}  
%if "&i" = "1" || "&i" > "3"  
{  
"the variable i is one OR is greater than three"  
}
```

compare_strings

Syntax

```
string [ compare_operator ] string
```

Description

Compare two strings for a logical condition. The condition can be TRUE or FALSE.

Example

See lexical entity [compare_operator](#).

compare_operator

Syntax

Operator	Meaning
	equal to(default)
=	equal to
<>	not equal to
<	less than
<=	less than or equal to
>	greater than
>=	greater than or equal to

Description

The logical operators are used in the lexical entity *compare_strings*.

Example

equal to (default)	"A" "?A"
equal to	"A" = "?A"
not equal to	"A" <> "?A"
less than	"A" < "?A"
less than or equal to	"A" <= "?A"
greater than	"A" > "?A"
greater than or equal to	"A" >= "?A"

control_statement

Syntax

```
assign_statement | definition-statement | file_handling_statement | if_statement ↵
| loop_statement |
output_control_statement
```

Description

control_statements determine the processing logic of a template. They do not create output.

Example

See lexical entities:

- *assign_statement*
- *definition-statement*
- *file_handling_statement*
- *if_statement*
- *loop_statement*
- *output_control_statement*

definition-statement

Syntax

```
definition-of-base-type-template |  
definition-of-direction-template |  
definition-of-group-template |  
definition-of-index-template |  
definition-of-line-number-format-template |  
definition-of-member-separator-template |  
definition-of-names-format-template |  
definition-of-nest-level-format-template |  
definition-of-parent-identifier-template |  
definition-of-parent-index-template |  
definition-of-structure-template |  
definition-of-UnboundedArray-template.
```

Description

`definition_statements` give directives to the IDL Compiler. They do not create output.

Example

See lexical entities:

- [definition-of-base-type-template](#)
- [definition-of-direction-template](#)
- [definition-of-group-template](#)
- [definition-of-index-template](#)
- [definition-of-line-number-format-template](#)
- [definition-of-member-separator-template](#)
- [definition-of-names-format-template](#)
- [definition-of-nest-level-format-template](#)
- [definition-of-parent-identifier-template](#)
- [definition-of-parent-index-template](#)
- [definition-of-structure-template](#)
- [definition-of-UnboundedArray-template](#)

definition-of-base-type-template

Syntax

```
%using definition-of-base-type output-statement
```

Description

All references to the `output_substitution_sequence` `%type` in a `loop_over_parameters` are in the output as specified in *output_statement*. Default `output-statement` is "" (empty).

Example

A	%using A "unsigned char %name%index[%eLength]"
AV	%using AV "ERX_HVDATA %name%index"
B	%using B "unsigned char %name%index[%eLength]"
BV	%using BV "ERX_HVDATA %name%index"
D	%using D "unsigned char %name%index[ERX_GET_PACKED_LEN(7)]"
F4	%using F4 "float %name%index"
F8	%using F8 "double %name%index"
I1	%using I1 "signed char %name%index"
I2	%using I2 "short %name%index;"
I4	%using I4 "long %name%index;"
K	%using K "unsigned char %name%index[%eLength]"
KV	%usingKV "ERX_HVDATA %name%index"
L	%using L "unsigned char %name%index"
N	%using N "unsigned char %name%index[%before+%after]"
NU	%using NU "unsigned char %name%index[%before+%after]"
P	%using P "unsigned char" %name%index[ERX_GET_PACKED_LEN(%before+%after)]"
PU	%using PU "unsigned char %name%index[ERX_GET_PACKED_LEN(%before+%after)]"
T	%using T "unsigned char %name%index[ERX_GET_PACKED_LEN(13)]"

definition-of-base-type

Syntax

A | AV | B | BV | D | F4 | F8 | I1 | I2 | I4 | K | KV | L | N | NU | P | PU | T

Description

For a description of the definition-of-base-type see [IDL Data Types](#).

A	Reference to IDL data type Alphanumeric.
AV	Reference to IDL data type Alphanumeric variable length
B	Reference to IDL data type Binary.
BV	Reference to IDL data type Binary variable length.
D	Reference to IDL data type Date.
F4	Reference to IDL data type Floating point (small).
F8	Reference to IDL data type Floating point (large).
I1	Reference to IDL data type Integer (small).
I2	Reference to IDL data type Integer (medium).
I4	Reference to IDL data type Integer (large).
K	Reference to IDL data type Kanji.
KV	Reference to IDL data type Kanji variable length.
L	Reference to IDL data type Logical.
N	Reference to IDL data type Unpacked decimal.
NU	Reference to IDL data type Unpacked decimal unsigned.
P	Reference to IDL data type Packed decimal.
PU	Reference to IDL data type Packed decimal unsigned.
T	Reference to IDL data type Time.

definition-of-direction-template

Syntax

```
%using %direction output-statement output-statement output-statement
```

Description

All references to the `output_substitution_sequence %direction` in a `loop_over_parameters` are in the output as specified in `output-statement`. If a parameter is of direction IN, the first `output-statement` will be used, the second `output-statement` will be used for direction OUT and the third for INOUT (see [attribute-list](#)). Default `output-statement` is "" "" "" (empty).

Example

```
%using %direction "In" "Out" "In Out"
```

definition-of-group-template

Syntax

```
%using G output-statement output-statement
```

Description

If the parameter is a group (see [group-parameter-definition](#)) in a `loop_over_parameters`, all references to the `output_substitution_sequence %type` will be written into the output as specified in the `output-statements`. The first `output-statement` is the group prefix, typically the data type of the target programming language. The second `output-statement` is the group suffix which usually indicates the end of the group. Default `output-statement` is "" (empty).

Example

```
%using G "struct {" "%outBlank} %name;"
```

definition-of-index-template

Syntax

```
%using %index output-statement output-statement output-statement output-statement
```

Description

All references to the `output_substitution_sequence` `%index` in a `loop_over_parameters` will be written into the output as specified in the `output-statement`s. According to the IDL (see [array-definition](#)), up to 3 dimensions are supported. The first `output-statement` is for scalar parameters, the second `output-statement` for 1-dimensional arrays, the third `output-statement` for 2-dimensional arrays and the fourth `output-statement` for 3-dimensional arrays. Default `output-statement` is "" (empty).

Example

```
%using %index "" "[%1_index]" "[%2_index][%1_index]"  
            "[%3_index][%2_index][%1_index]"
```

definition-of-line-number-format-template

Syntax

```
%using %NumberLine output-statement
```

Description

All references to the `output_substitution_sequence` `%LibCount`, `%ProgCount` and `%NameCount` are written into the output as specified in the `output-statement`s. The `output-statement` uses the C `printf` format notation. Default `output-statement` is `%u`.

Example

```
%using %NumberLine "%.4u"
```

definition-of-member-separator-template

Syntax

```
%using %member output-statement
```

Description

Specify a template for a fully qualified name of parameters. All references to the `output_substitution_sequence %member` in a `loop_over_parameters` are written into the output as specified in the `output-statements`. The IDL Compiler builds an internal tree hierarchy of parameters, structures and groups. If a parameter has a parent, it will be inserted before the fully qualified name. If a parameter has no parent, the `output-statement` will not be used. Default `output-statement` is "" (empty).

Example

```
%using %member "%name%Index."
```

definition-of-names-format-template

Syntax

```
%using %Format output-statement
```

Description

Specify a template for library, program or parameter name strings. All references to the `output_substitution_sequence %OutputLevel` in a `loop_over_parameters` are written into the output as specified in the `output-statements`. The `output-statement` uses the C `printf` format notation. Default `output-statement` is `%s`.

Example

```
%using %Format "%s.ext"
```

definition-of-OutBlank-template

Syntax

```
%using %outBlank output-statement
```

Description

The `output-statement` definition replaces the blank (default), which will be used with the `%outBlank` statement. The statement will not be interpreted and will be used as it is. You cannot write an expression (`string_with_expression_contents`) or a variable (`variable_of_type_string` string) in this output statement. See the table entry [definition-of-OutBlank-template](#) in the section [output_substitution_sequence](#) for further information.

Example

```
%using %outBlank "\t"
```

definition-of-nest-level-format-template

Syntax

```
%using %OutputLevel output-statement
```

Description

Specify a template for nesting level strings. The nesting level is the depth where a parameter is specified. All references to the `output_substitution_sequence` `%OutputLevel` in a `loop_over_parameters` are written into the output as specified in the `output-statements`. The `output-statement` uses the C `printf` format notation. Default `output-statement` is `%using`.

Example

```
%using %OutputLevel "%u"
```

definition-of-parent-identifier-template

Syntax

```
%using %Xparent output-statement output-statement
```

Description

Specify a template for the parent. All references to the `output_substitution_sequence` `%Xparent` in a `loop_over_parameters` are written into the output as specified in the `output-statements`. If a parameter has no parent and the second `output-statement` is not empty, the second `output-statement` is used, otherwise, the first. The first `output-statement` uses the C `printf` format notation. Default is `"%u" ""` (second statement is empty).

Example

```
%using %Xparent "%d" "ERX_NO_PARENT_V2"
```

definition-of-parent-index-template

Syntax

```
%using %Index output-statement output-statement output-statement output-statement
```

Description

Specify a template for a parameter's parent index. The IDL Compiler builds an internal tree hierarchy of parameters, structures and groups. A parameter's immediate parent in this hierarchy can be an array. All references to the `output_substitution_sequence` `%Index` in a `loop_over_parameters` are written into the output source code as specified in the `output-statements`. The `output-statement` describes the syntax for defining arrays of up to 3 dimensions as defined by the IDL (see [array-definition](#)). The `Output_substitution_sequence` `%Index` (uppercase I) is very similar to the `output_substitution_sequence` `%index` (defined with [definition-of-index-template](#)), but is useful only for building member names using `output_substitution_sequence` `%member`. Default `output-statement` is `""` (empty).

Example

```
%using %Index "" "[0]" "[0][0]" "[0][0][0]"
```

```
%using %member "%Index."
```

definition-of-structure-template

Syntax

```
%using S output-statement
```

Description

If the parameter is a structure (see [structure-parameter-definition \(IDL\)](#)) in a `loop_over_parameters`, all references to the `output_substitution_sequence` `%type` will be written into the output as specified in the `output-statements`. "INCLUDE AS GROUP" specified as the `output-statement` will embed all parameters (see [parameter-data-definition](#)) of the structure as if they were a group.

Example

```
%using S "INCLUDE AS GROUP"
```

definition-of-UnboundedArray-template

Syntax

```
%using UnboundedArray output-statement  
%using UnboundedArray ""
```

Description

If the parameter is an unbounded array (see *array-definition*) in a `loop_over_parameters`, all references to the `output_substitution_sequence %type` will be written into the output as specified in the `output-statements` statement, i.e. the settings of the *definition-of-base-type* are overwritten. The first form overwrites the settings of the *definition-of-base-type*. The second form switches back to the *definition-of-base-type* settings.

Example

```
%using UnboundedArray "ERX_HARRAY"
```

error_statement

Syntax

```
%error output_character_sequence
```

Description

Use the `error_statement` to exit your template with an error message. The execution of the template will be stopped at this statement and the error message will be given to the caller. The `%error` statement can be used in the main template and in subtemplates as well. The execution of the whole template compiling process will be stopped regardless of the type of template it is used in.

Example

```
%if "$(TARGET)" <> "COBOL" && "$(TARGET)" <> "BATCH"
{
    %error "TARGET not supported."
}
```

execute_statement

Syntax

```
%execute output-statement [(parameter_list)] [return (return_list)]
```

Description

Use the `%execute` statement to include another template file in the current template file like a subprogram. You can outsource often-used code to an external template file. The executed template file uses a `NEW CLEAN` environment context. Only the `%library`, `%program`, `%x_struct`, `%name`, `%LibCount`, `%ProgCount` and `%NameCount` are known in the executed template file. No other variables or IDL parameters (`output_substitution_sequence`) are defined in the executed template file. You *must* for example have a `%name` loop (`loop_over_parameters`) to have access to an IDL parameter (`output_substitution_sequence`). All changes in the executed files will be lost after calling the include file and will have no effect in the calling template.

The `%execute` statement can be called with a list of parameters (`parameter_list`). The `parameter_list` needs to be set in brackets. This list of parameters will be copied into the variables in the executed file in the following order: `?A`, `?B`, `?C`, . . ., for example a list of parameters in the `%execute` statement (`"AA" "BB" "CC" "DD"`). These parameters will be available in the following variables: `"?A" => "AA"`, `"?B" => "BB"`, `"?C" => "CC"`, `"?D" => "DD"`.

The `%execute` statement can have a "return" statement to return a list of parameters (`return_list`), as well. This *return_list* has to be returned with the *return_statement*. The count of the expected and the returned parameter must be the same and the type of the parameters must match. For example, if the expected return parameter is a *variable_of_type_string*, the return parameter type must be a `variable_of_type_string` and if the expected return parameter is a *variable_of_type_integer*, the return parameter type must be a `variable_of_type_integer`.

Example 1

```
%execute "subprog.tpl" ("?A" "&i" "10")  
  
%execute "subprog.tpl" ("?Z" "%OutputLevel" "subprog" "10") return ("?C" "&f")
```

Example 2

```

File main.tpl
%assign A "Test variable A"
%assign B "Test variable B"
%assign C "Length of A and B is"
%compute i "#A" ; length of the variable A
%compute j "#B" ; length of the variable B
%execute "calc.tpl" ("?C" "&i" "&j") return ("?Z")
"?Z\n" ; print the returned variable
; the output should be "Length of A and B is 30"
File calc.tpl
; the execute parameters are in the following variables
; ?A => the ?C of the main template = "Length of A and B is"
; ?B => the &i of the main template = "15"
; ?C => the &j of the main template = "15"
%compute a "?B + ?C"
%assign T "?A &a"
%return ("?T")

```

file_handling_statement

Syntax

```
%file [output-statement]
```

Description

Use the %file statement to direct the output to a specific file. Only one file can be open at a time. If no file is open, all output goes to `STDOUT` by default. If `output-statement` is left blank, the file currently open is closed. All open files are implicitly closed if either a new open file statement is encountered or the IDL Compiler terminates.

Example

```

%file "%library.MAK" ; open a file
....
%file "" ; close the file

```

if_statement

Syntax

```
%if compare_expression statement [if-elif-extension] [%else statement]
```

Description

If *compare_expression* is TRUE, then interpret statement. If *compare_expression* is FALSE and if there is an if-elif-extension, interpret the if-elif-extension.

If all *compare_expressions* in all if-elif-extensions are FALSE and if there is an else block, interpret the statement in the else block.

Example

```
%if "%type%index" ""
    "\n"
%elif "%index" ""
    "(%type)\n"
%else
    "(%type%index)\n"
```

if_elif_extension

Syntax

```
%elif compare_expression statement [if-elif-extension]
```

Description

If *compare_expression* is TRUE, then interpret the statement. If *compare_expression* is FALSE and if there is an if-elif-extension, interpret the if-elif-extension.

Example

See lexical entity [if_statement](#).

logical_compare_operator

Syntax

&&	logical AND operator
	logical OR operator

Description

The logical operators perform logical AND (&&) and logical OR (||) operations. The logical AND operator has a higher priority than the logical OR operator.

Example

See the lexical entity [compare_expression](#).

loop_statement

Syntax

```
loop_over_libraries | loop_over_parameters | loop_over_programs | ↵
loop_over_structures | loop_of_while
```

Description

Loop sequences instruct the IDL Compiler to loop through all occurrences of libraries (see [library-definition](#)), programs (see [program-definition](#)), structures (see [structure-definition](#)) and parameters (see [parameter-data-definition](#)).

Example

See lexical entities:

- [loop_over_libraries](#)
- [loop_over_parameters](#)
- [loop_over_programs](#)
- [loop_over_structures](#)
- [loop_of_while](#)

loop_over_libraries

Syntax

```
%library statement
```

Description

This loop statement instructs the IDL Compiler to loop through all occurrences of libraries (see [library-definition](#)).

Example

```
%library  
{  
    ....  
}
```

loop_over_parameters

Syntax

```
%name statement
```

Description

This loop statement instructs the IDL Compiler to loop through all occurrences of parameters (see [parameter-data-definition](#)). A loop over parameters must be placed in a [loop_over_programs](#) or [loop_over_structures](#).

Example

```
%name  
{  
    ....  
}
```

loop_over_programs

Syntax

```
%program statement
```

Description

This loop statement instructs the IDL Compiler to loop through all occurrences of programs (see [program-definition](#)). A loop over programs must be placed in a [loop_over_libraries](#).

Example

```
%program  
{  
    ....  
}
```

loop_over_structures

Syntax

```
%x_struct statement
```

Description

This loop statement instructs the IDL Compiler to loop through all occurrences of structures (see [structure-definition](#)). A loop over structures must be placed in a [loop_over_libraries](#) or [loop_over_programs](#). In a [loop_over_libraries](#) all structures in the library (see [library-definition](#)) are accessed. In a [loop_over_programs](#) all structures in the current program (see [program-definition](#)) are accessed.

Example

```
%structure  
{  
    ....  
}
```

loop_of_while

Syntax

```
%while compare_expression statement
```

Description

Loop while [compare_strings](#) is TRUE.

Example

```
%compute i "0"
%while "&i" < "10"
{
    . . . .
    %compute i "&i + 1"
}
```

message_statement

Syntax

```
%message output_character_sequence
```

Description

Use the `message_statement` to notify the template user with a message. The `output_character_sequence` will report as the message on the console.

Example

```
%if "%eLength" > "32766"
{
    %message "Maximum length for %type usually 32766"
}
```

output

Syntax

```
output_character_sequence | output_escape_sequence | output_formatting_sequence | ←
output_of_variable |
output_substitution_sequence
```

Description

See lexical entities:

- *output_character_sequence*
- *output_escape_sequence*
- *output_formatting_sequence*
- *output_of_variable*
- *output_substitution_sequence*

Example

See lexical entities:

- *output_character_sequence*
- *output_escape_sequence*
- *output_formatting_sequence*
- *output_of_variable*
- *output_substitution_sequence*

output_character_sequence

Description

Simple sequences of characters not matching other output such as *output_escape_sequence*, *output_formatting_sequence*, *output_of_variable* or *output_substitution_sequence* form a character sequence.

Example

```
"This is a character sequences in an output statement."
```

output_control_ims

Syntax

```
%IMS+ | %IMS- | %IMS
```

Description

The IMS flag. If this flag is set, the parameter in the `loop_over_parameters`, that are marked with the IMS attribute in the IDL file will also be taken into consideration. If this flag is off, all parameters that are marked with the IMS attribute will be ignored. If + or - are not specified, the flag will be toggled. The default is off.

Example

```
%IMS+
%library
{
  %program
  {
    %name
    {
      "%name"
    }
  }
}
```

output_control_imsonly

Syntax

```
%IMSONLY+ | % IMSONLY - | % IMSONLY
```

Description

The `IMSONLY` flag. If this flag is set, parameters in the `loop_over_parameters` that are not marked with the `IMS` attribute in the IDL file will be ignored. If this flag is off, the `loop_over_parameters` will work as usual. If `+` or `-` are not specified, the flag will be toggled. The default is off.

Example

```
%IMSONLY+
%library
{
  %program
  {
    %name
    {
      "%name - this parameter has an ims attribute"
    }
  }
}
```

output_control_lower_upper

Syntax

(Defaults are underlined.)

```
%UpperCase+ | %UpperCase- | %UpperCase
%UpperCasePgm+ | %UpperCasePgm- | %UpperCasePgm
%LowerCase+ | %LowerCase- | %LowerCase
```

Description

UpperCase	Name uppercase flag. If this flag is set, <code>%name</code> substitution_sequences written to the output will be converted to uppercase. If no <code>+</code> or <code>-</code> is specified, the flag will be toggled. The default is off.
UpperCasePgm	Program uppercase flag. If this flag is set, <code>%program</code> substitution_sequences written to the output will be converted to uppercase. If no <code>+</code> or <code>-</code> is specified, the flag will be toggled. The default is off.
LowerCase	Name lowercase flag. If this flag is set, <code>%name</code> substitution_sequences written to the output will be converted to lowercase. If no <code>+</code> or <code>-</code> is specified, the flag will be toggled. The default is on.

Example

UpperCase	<u>%UpperCase+</u>	Set name uppercase flag on.
	<u>%UpperCase-</u>	Set name uppercase flag off.
	<u>%UpperCase</u>	Toggle name uppercase flag.
UpperCasePgm	<u>%UpperCasePgm+</u>	Set program uppercase flag on.
	<u>%UpperCasePgm-</u>	Set program uppercase flag off.
	<u>%UpperCasePgm</u>	Toggle program uppercase flag.
LowerCase	<u>%LowerCase+</u>	Set name lowercase flag on.
	<u>%LowerCase-</u>	Set name lowercase flag off.
	<u>%LowerCase</u>	Toggle name lowercase flag.

output_control_sanitize**Syntax**

(Defaults are underlined.)

```
%Sanitize+ | %Sanitize- | %Sanitize %SanitizeCamelCased+ | %SanitizeCamelCased- |
%SanitizeCamelCased %SanitizeCobol+ | %SanitizeCobol- | %SanitizeCobol ←
%SanitizePascalCased+ |
%SanitizePascalCased- | %SanitizePascalCased
```

Description

Sanitize	Sanitize flag for C programming language. If this flag is set, %x_struct, %u_struct, %name, %program and %library substitution sequences written to the output will be forced to follow C conventions. The special characters '#', '\$', '&', '+', '-', '.', '/' and '@' in parameter names permitted in the IDL file will be converted to underscores '_' to produce valid C names. If + or - are not specified, the flag will be toggled. The default is on.
SanitizeCamelCased	Sanitize flag for C# programming language. If this flag is set, %x_struct, %u_struct, %name, %program and %library substitution sequences written to the output will be forced to follow camel cased naming conventions as they are used in C#. The special characters '#', '\$', '&', '+', '-', '.', '/', '@' and '_' in parameter names permitted in the IDL file will be removed. The character following the special character will be converted to uppercase and all other characters to lowercase. The very first character within %name, %program, and %library substitution sequences will be converted to lowercase. %UpperCase- and %LowerCase- must be set also to have CamelCased names. If + or - are not specified, the flag will be toggled. The default is off.

SanitizeCobol	Sanitize flag for COBOL programming language. If this flag is set, %x_struct, %u_struct, %name, %program and %library substitution sequences written to the output will be forced to follow COBOL conventions. The special characters '#', '\$', '&', '+', ':', '/', '@' and '_' in parameter names permitted in the IDL file will be converted to hyphen '-' to produce valid COBOL names. . If a parameter name starts with a digit, e.g. '1', it is prefixed with the character 'P'. If + or - are not specified, the flag will be toggled. The default is off.
SanitizedCOMWrapper	Sanitize flag for DCOM Wrapper. If this flag is set, %x_struct, %u_struct, %name, %program and %library substitution sequences written to the output will be forced to follow DCOM conventions. The special characters '#', '\$', '&', '+', '-', ':', '/' and '@' in parameter names permitted in the IDL file will be converted to underscores '_' to produce valid DCOM names. All preceding underscores in parameter names are deleted. If a parameter name starts with a digit, e.g. '1', it is prefixed with the character 'P'. If + or - are not specified, the flag will be toggled. The default is on.
SanitizePascalCased	Sanitize flag for C# programming language. If this flag is set, %x_struct, %u_struct, %name, %program and %library substitution sequences written to the output will be forced to follow Pascal-cased naming conventions as they are used in C#. The special characters '#', '\$', '&', '+', '-', ':', '/', '@' and '_' in parameter names permitted in the IDL file will be removed. The character following the special character will be converted to uppercase and all other characters to lowercase. The very first character in the %name, %program and %library substitution sequences will be converted to uppercase. %UpperCase- and %LowerCase- must be set also to have PascalCased names. If + or - are not specified, the flag will be toggled. The default is off.
SanitizePLI	Sanitize flag for the PL/I programming language. If this flag is set, %x_struct, %u_struct, %name, %program and %library substitution sequences written to the output will be forced to follow PL/I conventions. The special character '&', '+', '-', ':' and '/' in parameter names permitted in the IDL file will be converted to underscores '_' to produce valid PL/I names. If + or - are not specified, the flag will be toggled. The default is off.

Example

Sanitize	%Sanitize+	Set Sanitize flag for C variable names on.
	%Sanitize-	Set Sanitize flag for C variable names off.
	%Sanitize	Toggle Sanitize flag for C variable names.
SanitizeCamelCased	%SanitizeCamelCased+	Set Sanitize flag for C# parameter names on.
	%SanitizeCamelCased-	Set Sanitize flag for C# parameter names off.
	%SanitizeCamelCased	Toggle Sanitize flag for C# parameter names.
SanitizeCobol	%SanitizeCobol+	Set Sanitize flag for COBOL variable names on.
	%SanitizeCobol-	Set Sanitize flag for COBOL variable names off.
	%SanitizeCobol	Toggle Sanitize flag for COBOL variable names.
SanitizedCOMWrapper	%SanitizedCOMWrapper+	Set Sanitize flag for DCOM names on.

	%SanitizeDCOMWrapper-	Set Sanitize flag for DCOM names off.
	%SanitizeDCOMWrapper	Toggle Sanitize flag for DCOM names.
SanitizePascalCased	%SanitizePascalCased+	Set Sanitize flag for C# member names on.
	%SanitizePascalCased-	Set Sanitize flag for C# member names off.
	%SanitizePascalCased	Toggle Sanitize flag for C# member names.
SanitizePLI	%SanitizePLI+	Set Sanitize flag for PL/I member names on.
	%SanitizePLI-	Set Sanitize flag for PL/I member names off.
	%SanitizePLI	Toggle Sanitize flag for PL/I member names.

output_control_statement

Syntax

```
output_control_lower_upper | output_control_sanitize |
output_control_verbose
```

Description

Use the flags to force upper/lowercase conversions, C, C# or COBOL language conventions or, for example, for comments to be written into the output. The default setting when you do not code any `output_control_statements` are forced to follow the C programming language convention.

Example

See under the lexical entities:

- `output_control_lower_upper`
- `output_control_sanitize`
- `output_control_verbose`

output_control_verbose

Syntax

```
%verbose+ | %verbose- | %verbose
```

Description

Verbose flag. If this flag is set, template file `output-statements` will be written to the output without being interpreted, e.g. the `substitution_sequences` are output as is and not replaced by their meaning. If + or - are not specified, the flag will be toggled. The default is off.

Example

```
%verbose+  
/* This is file %program.c */  
/* Please do not modify this file */  
%verbose
```

output_escape_sequence

Syntax

```
\\
```

Description

The escape character is used to change the meaning of the special characters `&`, `?` and `#` back to their normal meaning. Special characters access variables using the *output_of_variable* lexical entity. With escape characters it is possible to insert a plain `&` by typing: `\\&`.

Example

```
"This string contains an ampersand \&."
```

output_formatting_sequence

Syntax

Sequence	Meaning
\n	Newline
\r	Carriage return
\t	Horizontal tab
\ddd	ASCII character in octal notation, e.g. \012 for the new line
\xdd	ASCII character in hex notation, e.g. \x09 for the horizontal tab

Description

Formatting sequences are output control characters such as newline, backspace, etc. For characters in hexadecimal notation, the IDL Compiler ignores all leading zeros. It establishes the end of the hex-specified escape character when it encounters either the first non-hex character or more than two hex characters not including leading zeros. In the latter case, it reports an error and ignores all characters beyond the second one.

Example

```
"This string ends on this line.\n"
```

output_of_variable

Syntax

```
??variable_of_type_indexed_string | ### variable_of_type_indexed_string
    | &variable_of_type_integer | ?variable_of_type_string | ↵
#variable_of_type_string | $(...)
```

Description

This form of accessing variables can be used in `output_statements`. If it is used, the variable content is written to the output.

Example

&a	substitutes the integer variable with its number.
?A	substitutes the string variable with its contents.
??A[0]	substitutes the indexed string variable with its contents.
#A	substitutes the string variable with an integer of the length of its contents.
###B[%OutputLevel]	substitutes the indexed string variable with an integer of the length of its contents.
\$(TEMP)	substitutes the option variable with its contents.

output_statement

Syntax

```
'" { output } "'
```

Description

`output` is a string consisting of an *output_character_sequence*, *output_escape_sequence*, *output_formatting_sequence*, *output_of_variable* or an *output_substitution_sequence* in any order.

Example

```
"This is simple output."
```

output_substitution_sequence**Syntax**

Sequence	Meaning												
%after	<p>Inserts the digits after the decimal point of the current parameter (see simple-parameter-definition) into the output.</p> <p>This substitution sequence can only be used in an active loop_over_parameters, and if the current parameter is of data type N, NU, P, PU. Using it with other data types will lead to an error</p>												
%Alias	<p>If a library alias name is used, inserts the library alias name of the current library (see library-definition) into the output. If no alias is provided, the library name (contents of %library) is provided in the %Alias substitution sequence. This substitution sequence can only be used in an active loop_over_libraries.</p>												
%before	<p>Inserts the digits before decimal point of the current parameter (see simple-parameter-definition) into the output.</p> <p>This substitution sequence can be used only in an active loop_over_parameters, and if the current parameter is of data type N, NU, P, PU. Using it with other data types will lead to an error.</p>												
%Count	<p>Inserts the output's current line number. The format is controlled by the definition-of-names-format-template.</p>												
%direction	<p>Inserts the direction of the current parameter (see parameter-data-definition) into the output as specified with definition-of-direction-template. This substitution sequence can only be used in an active loop_over_parameters.</p>												
%eLength	<table border="1"> <thead> <tr> <th>Data Type</th> <th>Description</th> </tr> </thead> <tbody> <tr> <td>A,K,B,I,F,U</td> <td>Logical length as set in the IDL file.</td> </tr> <tr> <td>AV,KV,BV,UV</td> <td>Maximum logical length as set in the IDL file.</td> </tr> <tr> <td>L</td> <td>Type L has no explicit logical length in the IDL file. However, the length is always set to 1.</td> </tr> <tr> <td>N,NU,P,PU</td> <td>Digits before and after decimal point in encoded form as given in the IDL file. Use the macro ERX_GET_DIGITS (see erx.h) to get the digits before the decimal point. Use the macro ERX_GET_DECIMALS (see erx.h) to get the number of digits after the decimal point.</td> </tr> <tr> <td>T</td> <td>Type T has no explicit logical length in the IDL file. However, the length is always set to 12.</td> </tr> </tbody> </table>	Data Type	Description	A,K,B,I,F,U	Logical length as set in the IDL file.	AV,KV,BV,UV	Maximum logical length as set in the IDL file.	L	Type L has no explicit logical length in the IDL file. However, the length is always set to 1.	N,NU,P,PU	Digits before and after decimal point in encoded form as given in the IDL file. Use the macro ERX_GET_DIGITS (see erx.h) to get the digits before the decimal point. Use the macro ERX_GET_DECIMALS (see erx.h) to get the number of digits after the decimal point.	T	Type T has no explicit logical length in the IDL file. However, the length is always set to 12.
	Data Type	Description											
	A,K,B,I,F,U	Logical length as set in the IDL file.											
	AV,KV,BV,UV	Maximum logical length as set in the IDL file.											
	L	Type L has no explicit logical length in the IDL file. However, the length is always set to 1.											
	N,NU,P,PU	Digits before and after decimal point in encoded form as given in the IDL file. Use the macro ERX_GET_DIGITS (see erx.h) to get the digits before the decimal point. Use the macro ERX_GET_DECIMALS (see erx.h) to get the number of digits after the decimal point.											
T	Type T has no explicit logical length in the IDL file. However, the length is always set to 12.												

Sequence	Meaning	
	Data Type	Description
	D	Type D has no explicit logical length in the IDL file. However, the length is always set to 6.
%file		Inserts the current filename into the output.
%Format		Inserts into the output the base name as given by the -F parameter on start of the <i>The Software AG IDL Compiler</i> . If no -F parameter is provided during start of the IDL Compiler, the base name of the idl-file without path and extension is inserted into the output.
%index		Inserts the index of the current parameter (see <i>parameter-data-definition</i>) into the output as specified with <i>definition-of-parent-index-template</i> . This substitution sequence can only be used in an active <i>loop_over_parameters</i> .
%LibCount		Inserts the total number of libraries (see <i>library-definition</i>) as given in the IDL file into the output. The format is controlled by the <i>definition-of-line-number-format-template</i> .
%library		Inserts the current library name (see <i>library-definition</i>) into the output. The inserted library name is controlled by <i>output_control_statement</i> . This substitution sequence can only be used in an active <i>loop_over_libraries</i> .
%member		Inserts the fully qualified member name: (parent...parent...child) into the output. The member name is controlled by <i>definition-of-member-separator-template</i> . This substitution sequence can only be used in an active <i>loop_over_parameters</i> .
%Method		If a program alias is used, inserts the program alias name of the current program (see <i>program-definition</i>) into the output. If no alias is provided, the program name (contents of %program) is provided. This substitution sequence can only be used in an active <i>loop_over_programs</i> .
%name		Inserts the current parameter name (see <i>parameter-data-definition</i>) into the output. The parameter name is controlled by <i>output_control_statement</i> . This substitution sequence can only be used in an active <i>loop_over_parameters</i> .
%NameCount		Inserts the total number of parameters (see <i>parameter-data-definition</i>) of the current program (see <i>program-definition</i>) into the output. The format is controlled by the <i>definition-of-line-number-format-template</i> . This substitution sequence can only be used in an active <i>loop_over_programs</i> .
%outBlank		Writes n blanks (n = nesting level of parameter) into the output according to the level of the current parameter (see <i>parameter-data-definition</i>). This substitution sequence can only be used in an active <i>loop_over_parameters</i> . You can replace the blank with another output statement by using (<i>%using %outBlank output-statement</i>).
%OutputLevel		Inserts the level of the parameter (see <i>parameter-data-definition</i>) into the output. This substitution sequence can only be used in an active <i>loop_over_parameters</i> .
%ProgCount		Inserts the total number of programs (see <i>program-definition</i>) in the current library into the output. The format is controlled by the <i>definition-of-line-number-format-template</i> . This substitution sequence can only be used in an active <i>loop_over_libraries</i> .

Sequence	Meaning
%program	Inserts the current program (see program-definition) name into the output. The output is controlled by output_control_statement . This substitution sequence can only be used in an active loop_over_programs .
%type	Inserts the parameter type (see parameter-data-definition) into the output. The parameter type is controlled by definition-of-base-type-template , definition-of-group-template , definition-of-UnboundedArray-template and definition-of-structure-template . This substitution sequence can only be used in an active loop_over_parameters .
%size (deprecated, should no longer be used!)	The %size substitution sequence is deprecated and should no longer be used. Use %eLength substitution sequence instead. Using %size will lead to an error.
%TypeAttributes	<p>The substitution sequence %TypeAttributes produces a 2-byte bitmask indicating</p> <ul style="list-style-type: none"> ■ for arrays (see simple-parameter-definition) whether dimensions are fixed or unbounded (see array-definition), ■ the aligned attribute (see attribute-list) for all types of parameters. <p>The bitmask displays the following:</p> <ul style="list-style-type: none"> ■ If an array and the 1st dimension is unbounded then bit 0 is ON rightmost. ■ If an array and the 2nd dimension is unbounded then bit 1 is ON. ■ If an array and the 3rd dimension is unbounded then bit 2 is ON. ■ If the aligned attribute is set then bit 3 is ON. <p>For users of the EntireX RPC C Runtime the bitmask corresponds directly to the ERXeAttributes defined for the ERX_PARAMETER_DEFINITION_V3. (see erx.h) This substitution sequence can only be used in an active loop_over_parameters.</p>
%u_struct	Inserts the name of the referenced structure (see structure-definition) into the output. The inserted name is controlled by output_control_statement . This substitution sequence can only be used in an active loop_over_parameters and only when the current parameter uses a structure as its type definition. See structure-parameter-definition (IDL) .
%x_struct	Inserts the name of the structure (see structure-definition) into the output. The inserted name is controlled by output_control_statement . This substitution sequence can only be used in an active loop_over_parameters .
%Xparent	Inserts the parameter's parent into the output. This substitution sequence can only be used in an active loop_over_parameters .
%0_index	Inserts the number of indices of the current parameter (see parameter-data-definition) into the output. This substitution sequence can only be used in an active loop_over_parameters .
%1_index	Inserts the count of elements in dimension 1 of the current parameter (see parameter-data-definition) into the output. The substitution sequence should be used for 1-dimensional parameters only (this can be checked with the %0_index

Sequence	Meaning
	substitution sequence). This substitution sequence can only be used in an active <i>loop_over_parameters</i> .
%2_index	Inserts the count of elements in dimension 2 of the current parameter (see <i>parameter-data-definition</i>) into the output. The substitution sequence should be used for 2-dimensional parameters only (this can be checked with the %0_index substitution sequence). This substitution sequence can only be used in an active <i>loop_over_parameters</i> .
%3_index	Inserts the count of elements in dimension 3 of the current parameter (see <i>parameter-data-definition</i>) into the output. The substitution sequence should be used for 3-dimensional parameters only (this can be checked with the %0_index substitution sequence). This substitution sequence can only be used in an active <i>loop_over_parameters</i> .
%SameLineComment	Inserts the text of the comment line of the current parameter from the IDL file. Use the parameter properties of the IDL Editor to set this comment line in the IDL file.
%SVMMetaData	Inserts the metadata part contained in a related server mapping file (see <i>Server Mapping Files for Natural</i>) of the current IDL program into the output. This substitution sequence can only be used in an active <i>loop_over_programs</i> . If there is no related mapping file, an empty string is inserted
%SVMFormatArea	Inserts the format area contained in a related server mapping file of the current IDL program into the output. This substitution sequence can only be used in an active <i>loop_over_programs</i> . If there is no related mapping file, an empty string is inserted
%SVMValueArea	Inserts the value area contained in a related server mapping file of the current IDL program into the output. This substitution sequence can only be used in an active <i>loop_over_programs</i> . If there is no related server mapping file, an empty string is inserted
%SVMStringArea	Inserts the string area contained in a related server mapping file of the current IDL program into the output. This substitution sequence can only be used in an active <i>loop_over_programs</i> . If there is no related server mapping file, an empty string is inserted
%SVMRpcProtocol	Inserts the RPC protocol version contained in a related server mapping file of the current IDL program into the output. This substitution sequence can only be used in an active <i>loop_over_programs</i> . If there is no related server mapping file, an empty string is inserted

Description

Substitution sequences are substituted by their actual contents during generation.

Example

```
"This is a substitution sequence containing the library: %library."
```

parameter_list

Syntax

```
(parameter_list)
```

Description

The `parameter_list` is an unnumbered count of parameters. This list of parameters needs to be set in brackets. Each parameter needs to be set in quotation marks and will be interpreted before using. Parameters will be separated by blanks. The `parameter_list` can be defined as an empty list, in which case the `return_list` needs to be defined only with the brackets "()".

Example

```
("param" "10" "?A" "&i" "%0_index" "%OutputLevel")
```

return_list

Syntax

```
(return_list)
```

Description

The `return_list` is an unnumbered count of parameters. This list of return parameters needs to be set in brackets. Each return parameter needs to be set in quotation marks. Parameters will be separated by blanks. Only `variable_of_type_string` and `variable_of_type_integer` are allowed in this list. `variable_of_type_indexed_string` is not allowed. It is also not allowed to use any constant string. The `return_list` can be defined as an empty list, in which case the `return_list` needs to be defined only with the brackets "()".

Example

```
("?A" "?Z" "&i" "&n")
```

return_statement

Syntax

```
%return (parameter_list)
```

Description

The `return_statement` will be used to return "return parameters" from an executed subtemplate. No statements after the `return_statement` will be executed. The subtemplate will return to the main template with this statement. If the `return_statement` has been placed in the main template, the execution of the template will be stopped as normal at this point.

Example

```
%return ("param" "10" "?A" "&i" "%0_index" "%OutputLevel")
```

statement

Syntax

```
block | control_statement | output_statement
```

Description

These are the 3 basic types of statements used in a template. A block is a sequence of statements. `Output_statements` create the output. `Control_statements` determine the processing logic.

Example

See under the lexical entities *control_statement* and *output_statement*.

string

Syntax

```
' ' { output } ' '
```

Description

Any kind of output can be used to form a string. A string is used to form the condition criteria in a *compare_strings* lexical entity used e.g. in *if_statement* and *loop_of_while*. A string is not written to the output.

Example

```
"String with contents of variable $A"
```

string_with_expression_contents

Syntax

```
' ' { output } ' '
```

Description

Any kind of output can be used to form *String_with_expression_contents*. However, this kind of string must adhere to the rules of an expression. A *string_with_expression_rules* is not written to the output.

Supported mathematical operations are:

+ addition

- subtraction

* multiplication

/ division

mod modulo operation; computes the remainder after dividing its first operand by its second

Supported bit operations are:

and bitwise AND operation
or bitwise OR operation
xor bitwise XOR operation

Precedence of operators:

*, /, %

+, -

xor, and, or

You may control the precedence of the operation with brackets.

Example

```
%compute a "%OutputLevel + 1"  
%compute b "%OutputLevel * 10"  
%compute c "%TypeAttribute mod 3"  
%compute d "(%TypeAttribute and 7) * 10"  
%compute e "%TypeAttribute or 1"  
%compute f "%TypeAttribute xor 3"
```

substring_statement

Syntax

```
%substring variable_of_type_string string from_position length |  
%substring variable_of_type_indexed_string string from_position length |
```

Description

Extract from the source variable *string* the substring *from_position* up to the length to *variable_of_type_string* or *variable_of_type_indexed_string*.

The parameters *from_position* and *length* are of *variable_of_type_integer*. It is *not* possible to use a *string_with_expression_contents* for *from_position* and *length*. For *length*, the constant *all* or *ALL* can be used to extract the rest of the source string starting from *from_position*. The first position of the source string is 0.

If *length* is longer than the length of the substring to extract, the available substring from *from_position* to the end of the string will be assigned (same as using the constant "all" for *length*). If the *from_position* is been higher as the length of the string, an empty string will be assigned. If the value of *from_position* or *length* is lower than 0, an error will occur.

Example

```
%compute f "0"
%compute l "32 + 10"
%substring A "These are all characters before position 42 and these are all ↵
characters after position 42" "&f" "&l"
%compute f "&f + &l"
%compute l "100"
%substring A[1] "These are all characters before position 42 and these are all ↵
characters after position 42" "&f" "&l"
```

After execution, the variable A contains the string “These are all characters before position 42” and variable A[1] contains the string “ and this are all characters after position 42”.

UnsupportedProgram_statement

Syntax

```
%UnsupportedProgram output_character_sequence
```

Description

Use the `UnsupportedProgram_statement` to notify the IDL Compiler that the current program in the current library is not supported and needs to be ignored in further processing. The template writer can inform the template user of the reason why this program is not supported with the `output_character_sequence`. Usually the template writer will mark a program as unsupported if the program contains unsupported data type in the IDL definition for the target programming language. The `output_character_sequence` will report as a message on the console.

This statement must be embedded in `loop_over_libraries` and `loop_over_programs`. Furthermore it cannot be used if a file was already open using `file_handling_statement`.

Example

```
%using K "K"
%library
{
  %program
  {
    %name
    {
      %if "%type" = "K"
      {
        %compute z "%eLength /2"
        %compute z "&z *2"
```

```
        %if "&z" <> "%eLength"  
        {  
            %UnsupportedProgram "Length for %type fields must be even."  
        }  
    }  
}
```

variable_index

Syntax

```
string_with_expression_contents
```

Description

Any `variable_index` follows the rules of a `string_with_expression_rules`. Additionally, the result of the expression is restricted to the range 0 - 8, i.e. indices must be in the range of 0 - 8. The `variable_index` is not written to the output.

Example

```
"2"  
"%OutputLevel"  
"&A + 1"
```

variable_name

Syntax

The variable name can be A - Z and a - z.

Description

Variable names are not case-sensitive. `variable_of_type_integer`, `variable_of_type_string` and `variable_of_type_indexed_string` are distinct variables.

Example

```
A  
B  
a  
b
```

`variable_of_type_indexed_string`

Syntax

```
variable-name[variable_index]
```

Description

`variable_of_type_indexed_string` are always correctly initialized to blanks.

Example

```
A[0]  
B[%OutputLevel]
```

`variable_of_type_integer`

Syntax

```
variable-name
```

Description

`variable_of_type_integer` are initialized to zero. They are defined in lowercase.

Example

```
a  
b
```

`variable_of_type_string`

Syntax

```
variable-name
```

Description

`variable_of_type_string` are always initialized to blanks. They are defined in uppercase.

Example

```
A  
B
```