

webMethods Closed Loop Analytics Help

Innovation Release

Version 10.2

April 2018

This document applies to webMethods Closed Loop Analytics Version 10.2 and to all subsequent releases.

Specifications contained herein are subject to change and these changes will be reported in subsequent release notes or new editions.

Copyright © 2015-2018 Software AG, Darmstadt, Germany and/or Software AG USA Inc., Reston, VA, USA, and/or its subsidiaries and/or its affiliates and/or their licensors.

The name Software AG and all Software AG product names are either trademarks or registered trademarks of Software AG and/or Software AG USA Inc. and/or its subsidiaries and/or its affiliates and/or their licensors. Other company and product names mentioned herein may be trademarks of their respective owners.

Detailed information on trademarks and patents owned by Software AG and/or its subsidiaries is located at <http://softwareag.com/licenses>.

Use of this software is subject to adherence to Software AG's licensing conditions and terms. These terms are part of the product documentation, located at <http://softwareag.com/licenses> and/or in the root installation directory of the licensed product(s).

This software may include portions of third-party products. For third-party copyright notices, license terms, additional rights or restrictions, please refer to "License Texts, Copyright Notices and Disclaimers of Third Party Products". For certain specific third-party license restrictions, please refer to section E of the Legal Notices available under "License Terms and Conditions for Use of Software AG Products / Copyright and Trademark Notices of Software AG Products". These documents are part of the product documentation, located at <http://softwareag.com/licenses> and/or in the root installation directory of the licensed product(s).

Use, reproduction, transfer, publication or disclosure is prohibited except as specifically provided for in your License Agreement with Software AG.

Table of Contents

About this Guide.....	5
Document Conventions.....	5
Online Information.....	6
Closed Loop Analytics Overview.....	7
About Closed Loop Analytics.....	8
Closed Loop Analytics Architecture.....	8
Installing and Configuring Closed Loop Analytics.....	11
Overview.....	12
Configuring Closed Loop Analytics.....	12
Customizing Email Settings in MashZone NextGen.....	13
Configuring the Analytic Engine and MashZone NextGen Server.....	13
Customizing the Optimize Email Settings.....	14
Configuring JMS Settings.....	14
Importing Closed Loop Analytics Assets to Software AG Designer.....	18
Upgrading a Closed Loop Analytics Installation.....	19
Reviewing Processes on the Business Process Dashboards.....	21
Overview.....	22
Types of Process Dashboards.....	22
Accessing the Business Process Dashboards.....	24
Escalating Problems.....	25
Overview.....	26
Sending an Instant Email.....	26
About the Escalation Workflow.....	26
Triggering the Escalation Workflow.....	27
Customizing the Escalation Workflow.....	29
Overview.....	30
Customizing the Default Escalation Process.....	30
Default Escalation Process Workflow.....	30
Customizing the Default Escalation Task.....	32
Customizing the Default Rule Project.....	32
Default Escalation Rule Project.....	33

About this Guide

This guide is for users of Closed Loop Analytics, a solution of the webMethods product suite to improve the performance of business processes. It describes how to monitor your business processes and trigger actions if needed.

webMethods Closed Loop Analytics Help contains supporting documentation on the following main topics:

- [“Closed Loop Analytics Overview”](#) on page 7.
- [“Installing and Configuring Closed Loop Analytics”](#) on page 11.
- [“Reviewing Processes on the Business Process Dashboards”](#) on page 21.
- [“Escalating Problems”](#) on page 25.
- [“Customizing the Escalation Workflow”](#) on page 29.

Document Conventions

Convention	Description
Bold	Identifies elements on a screen.
Narrowfont	Identifies storage locations for services on webMethods Integration Server, using the convention <i>folder.subfolder:service</i> .
UPPERCASE	Identifies keyboard keys. Keys you must press simultaneously are joined with a plus sign (+).
<i>Italic</i>	Identifies variables for which you must supply values specific to your own situation or environment. Identifies new terms the first time they occur in the text.
Monospace font	Identifies text you must type or messages displayed by the system.
{ }	Indicates a set of choices from which you must choose one. Type only the information inside the curly braces. Do not type the { } symbols.

Convention	Description
	Separates two mutually exclusive choices in a syntax line. Type one of these choices. Do not type the symbol.
[]	Indicates one or more options. Type only the information inside the square brackets. Do not type the [] symbols.
...	Indicates that you can type multiple options of the same type. Type only the information. Do not type the ellipsis (...).

Online Information

Software AG Documentation Website

You can find documentation on the Software AG Documentation website at "<http://documentation.softwareag.com>". The site requires Empower credentials. If you do not have Empower credentials, you must use the TECHcommunity website.

Software AG Empower Product Support Website

You can find product information on the Software AG Empower Product Support website at "<https://empower.softwareag.com>".

To submit feature/enhancement requests, get information about product availability, and download products, go to "[Products](#)".

To get information about fixes and to read early warnings, technical papers, and knowledge base articles, go to the "[Knowledge Center](#)".

Software AG TECHcommunity

You can find documentation and other technical information on the Software AG TECHcommunity website at "<http://techcommunity.softwareag.com>". You can:

- Access product documentation, if you have TECHcommunity credentials. If you do not, you will need to register and specify "Documentation" as an area of interest.
- Access articles, code samples, demos, and tutorials.
- Use the online discussion forums, moderated by Software AG professionals, to ask questions, discuss best practices, and learn how other customers are using Software AG technology.
- Link to external websites that discuss open standards and web technology.

1 Closed Loop Analytics Overview

- About Closed Loop Analytics 8
- Closed Loop Analytics Architecture 8

About Closed Loop Analytics

Closed Loop Analytics is a solution that enables you to quickly and easily improve the performance of your business processes. Closed Loop Analytics collects data about process health from products involved in business process execution and analysis. For example, it collects data on process volume and cycle times from Process Engine, and data on SLA or KPI rule violations from Optimize.

Closed Loop Analytics then displays the data on Business Process dashboards in MashZone NextGen or on the Analytics dashboard in webMethods Business Console. Process administrators review the data on the dashboards and escalate problems to users in the form of instant emails or escalation tasks. Users find the escalation tasks in their inboxes, perform root cause analyses, and write the results in the tasks. Process administrators review the results and use them to improve the processes.

The pre-configured escalation workflow can be customized by process administrators.

The Closed Loop Analytics workflow consists of:

- Reviewing processes on the Business Process dashboards.
- Escalating problems: Sending instant emails or creating escalation tasks.
- Solving the escalation tasks and writing the result in the task.
- Reviewing the results and using them to improve the process.
- Customizing and automating the escalation workflow.

Closed Loop Analytics Architecture

The following components must be installed and configured correctly to implement Closed Loop Analytics:

- Software AG Designer (Process Development, Rules Development, Task Development, UI Development, and Event Development)
- Asset Build Environment
- Integration Server (including Deployer and Rules Engine)
- My webMethods Server (including Task Engine, Central Configurator UI and webMethods Business Rules UI)
- Optimize (including Analytic Engine)
- Universal Messaging
- MashZone NextGen (including Business Process Dashboards)
- Closed Loop Analytics solution

- webMethods Business Console (optional, but recommended)

The following graphic shows the architecture of Closed Loop Analytics.

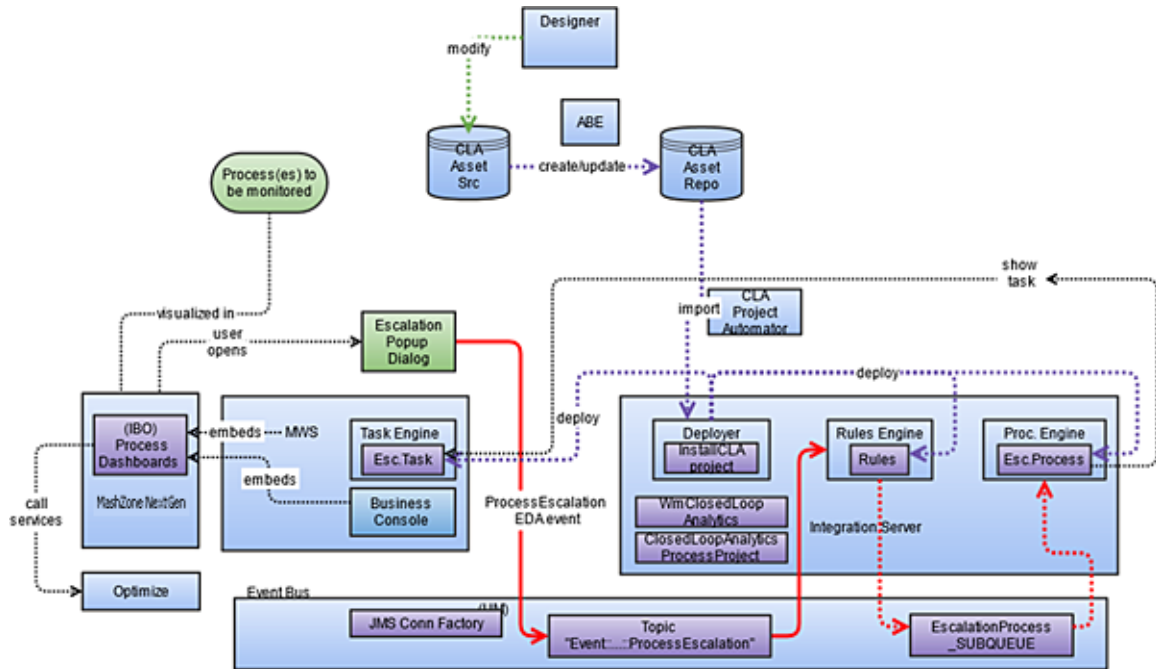

For more information about how to install and configure Closed Loop Analytics, see ["Installing and Configuring Closed Loop Analytics"](#) on page 11.

2 Installing and Configuring Closed Loop Analytics

■ Overview	12
■ Configuring Closed Loop Analytics	12
■ Configuring JMS Settings	14
■ Importing Closed Loop Analytics Assets to Software AG Designer	18
■ Upgrading a Closed Loop Analytics Installation	19

Overview

Closed Loop Analytics requires the installation and configuration of these components:

- Software AG Designer (Process Development, Rules Development, Task Development, UI Development, Event Development, and Closed Loop Analytics solution)
- Asset Build Environment
- Integration Server (including Deployer and Rules Engine)
- My webMethods Server (including Task Engine, Central Configurator UI and webMethods Business Rules UI)
- Optimize (including Analytic Engine)
- Universal Messaging
- MashZone NextGen (including Business Process Dashboards)
- webMethods Business Console (optional, but recommended)

See *Installing Software AG Products* for instructions.

See *Working with Business Process Dashboards* for instructions about deploying and configuring the Business Process dashboards.

If you are using Universal Messaging as a JMS provider, and it does not run locally, you must configure the JMS settings for Business Process Management and the Rules Engine on the appropriate Integration Server. For more information, see [“Configuring JMS Settings” on page 14](#).

As a last step, you must import the Closed Loop Analytics assets to Software AG Designer so that you can customize the predefined escalation workflow. For more information, see [“Importing Closed Loop Analytics Assets to Software AG Designer” on page 18](#).

Configuring Closed Loop Analytics

Configuring the Closed Loop Analytics solution requires the following steps:

1. Customize email settings in MashZone NextGen for MashZone NextGen users, see [“Customizing Email Settings in MashZone NextGen” on page 13](#).
2. Configure the Analytic Engine and MashZone NextGen server in the My webMethods system settings, see [“Configuring the Analytic Engine and MashZone NextGen Server” on page 13](#).
3. Customize Optimize email settings in My webMethods, see [“Customizing the Optimize Email Settings” on page 14](#).

Customizing Email Settings in MashZone NextGen

You must customize the MashZone NextGen email settings for user `Administrator` and for all additional users you defined. The MashZone NextGen email account is used as a sender address from the Business Process dashboards when sending an instant email.

To customize email settings in MashZone NextGen:

1. Log on to MashZone NextGen and switch to the Admin Console.
2. From the navigate tab, select **Users**.
3. In the list of usernames, identify `Administrator` and click the pencil icon behind the name.
4. In the Edit User pop-up dialog, enter a valid email address for username `Administrator` in the **Email** field. You can also specify a first and a last name. Click **Save changes**.
5. (Optional) Repeat this step for all other MashZone NextGen users you defined.
6. Ensure that the email accounts exist on your mail server.

Configuring the Analytic Engine and MashZone NextGen Server

You must configure the host name and port number for the Analytic Engine and the MashZone NextGen server in the My webMethods system settings. To perform this procedure, the Analytic Engine and the MashZone NextGen server must be installed and running.

To configure the Analytic Engine and the MashZone NextGen server:

1. Log on to My webMethods.
2. From the **Navigate** tab, select **Applications > Administration > My webMethods > System Settings > Servers**.
3. From the **Servers** panel, select the server scenario **BPM and BAM**.
4. Enter the host names and port numbers for the Analytic Engine and the MashZone NextGen server.

Note: Do not use `localhost` as a host name for the MashZone NextGen server.

5. Click **Check Server Status**. The lights turn green if the servers are configured correctly.
6. Click **Save**.

Customizing the Optimize Email Settings

You can configure and deploy the Optimize email settings using the My webMethods environment definition for the Analytic Engine. The mail server of the deployed settings is used by the Business Process dashboards when sending an instant email.

To customize the Optimize Email Settings:

1. Log on to My webMethods.
2. From the **Navigate** tab, select **Applications > Administration > System-Wide > Environments > Define Environment**.
3. From the **Configuration** panel, select **Analytic Engine > Mail Settings**.
4. On the **Mail Settings for Analytic Engine** panel, specify a valid mail server address.
5. (Optional) To test the connection, specify a valid sender domain and default sender and click **Test Connection**.
6. Click **Save**.
7. Deploy the modified connection to the Analytic Engine.

Configuring JMS Settings

If you are using Universal Messaging as a JMS provider, and it does not run locally, you must configure the JMS settings for Business Process Management and the Rules Engine on the appropriate Integration Server.

To configure JMS settings for BPM and the Rules Engine:

1. Start the following components: Universal Messaging server, My webMethods Server, and Integration Server.

If the Universal Messaging server does not run locally, you must configure JMS settings on the Integration Server:
 - a. In Integration Server Administrator: **Settings > Messaging**.
 - b. Click **webMethods Messaging Settings** under the webMethods Messaging Configuration heading.
 - c. In the webMethods Messaging Connection Alias Definition table list, verify that the **IS_UM_CONNECTION** alias exists and is configured as shown below. The Realm URL value must specify the location of the remote Universal Messaging server.

General Settings	
Connection Alias Name	IS_UM_CONNECTION
Description	system generated UM connection alias
Client Prefix	J_jRQtEoIDeurgAVIwwwADXaZQs_
Share Client Prefix	No
Connection Settings	
Realm URL	nsp://localhost:9000
Maximum Reconnection Attempts	5
Producer Settings	
Enable CSQ	Yes
Maximum CSQ Size (messages)	UNLIMITED
Drain CSQ in Order	Yes
Publish Wait Time while Reconnecting (milliseconds)	30000
Client Authentication Settings	
Client Authentication	None
Consumer Settings	
Enable Request-Reply Channel and Listener	Yes

- d. Click **Change Default Connection Alias**.
 - e. In the **Connection Alias Name** list, select 'IS_UM_CONNECTION' and click **Update**.
 - f. On the webMethods Messaging Settings page, enable IS_UM_CONNECTION.
2. Configure the JNDI connection using the Integration Server Administrator.
 - a. In Integration Server Administrator: **Settings > Messaging**.
 - b. Click **JNDI Settings** under the JMS Configuration heading.
 - c. In the JNDI Provider Alias Definition list, verify that DEFAULT_IS_JNDI_PROVIDER alias exists and its settings are as shown below (in particular, ensure that the **Provider URL** value specifies the remote Universal Messaging server).

JNDI Provider Alias	
JNDI Alias Name	DEFAULT_IS_JNDI_PROVIDER
Description	system generated JNDI provider alias
Initial Context Factory	com.pcbsys.nirvana.nSpace.NirvanaContextFactory
Provider URL	nsp://localhost:9000
Provider URL Failover List	
Security Principal	
Security Credentials	
Other Properties	

3. Start Enterprise Manager for Universal Messaging server and add `local_um` in the JNDI settings under **Connection Factories** (right the entry and select **New Connection Factory (Shared Durable)**).
 - a. In the ADD JNDI Connection Factory pop-up, enter `local_um` in the **Name** field, and enter `nsp://<hostname>:9000` in the **Connection URL (RNAME)** field.
 - b. Click **OK**.

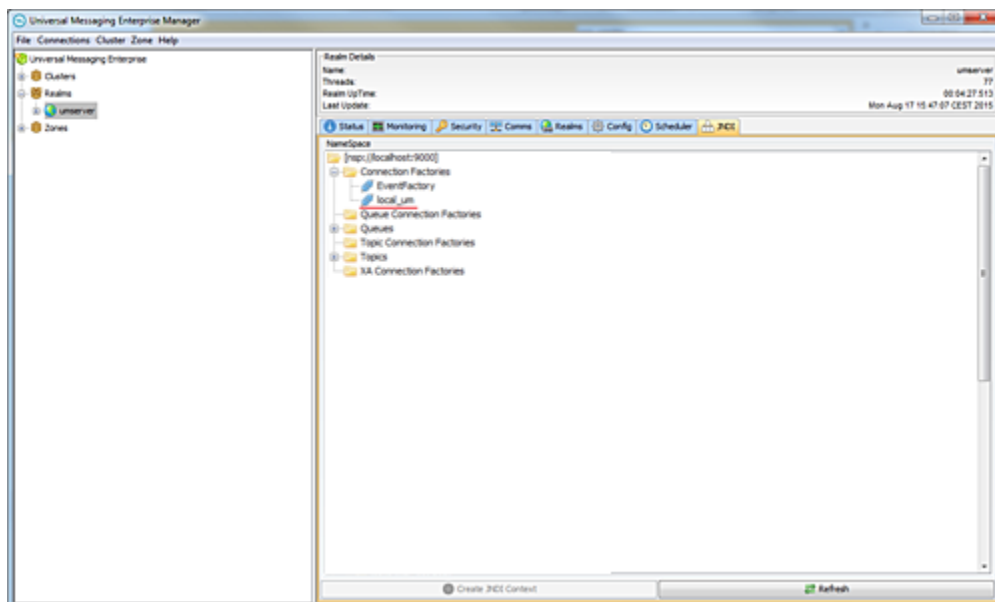

4. In a command line window, enter the following codeblock to create a topic for the escalation event type:

```
<instDir>/jvm/jvm/bin/java -jar <instDir>/common/lib/event-routing-jms-util.jar bind
nsp://localhost:9000
{http://namespaces.softwareag.com/EDA/WebM/Rules/CLA/1.0}ProcessEscalation
```

5. In Integration Server Administrator: **Settings > Messaging > JMS Settings**.
6. Enable the PE_NONTRANSACTIONAL_ALIAS aliases.
7. Restart the Integration Server.
8. In Deployer, complete the following:
 - a. In a command line window, navigate to the bin folder for Deployer as follows:

```
cd {InstallPath}/IntegrationServer/instances/default/packages/WmDeployer/bin
```
 - b. Import the CLA pre-packaged Deployer project by running the following:

```
./projectautomator[Unix.sh|.bat] {InstallPath}/Solutions/ClosedLoopAnalytics/Scripts/ProjectAutomator/InstallCLA_ProjectAutomator.xml
```

Optionally, you can also import the rule project into Software AG Designer from the source folder and export it to My webMethods Server.
 - c. Ensure that the email server settings in My webMethods are correct and enabled to support email feedback for Closed Loop Analytics. To check email settings, in My webMethods, select **Administration > My webMethods > E-mail Servers**.
9. In Deployer, provide Closed Loop Analytics assets to your product runtimes, using the following procedure:
 - a. Use Deployer to open the pre-packaged Deployer project.
 - b. Adjust this Deployer project by entering the server infrastructure and its components.
 - c. Deploy the project.
10. Restart Integration Server. Note that this step is necessary to activate the triggers in the WmClosedLoopAnalytics package.
11. If the Universal Messaging server does not run locally, enable the BPM process using the Integration Server service according to the following procedure.
 - a. In Integration Server Administrator: **Packages > Management > WmPRT**.
 - b. Click the wm.prt.model:enableProcessForExecution service.
 - c. Click **Test enable ProcessForExecution**.
 - d. Enter the following values:

ProcessModelID: ClosedLoopAnalyticsProcessProject/EscalationProcess

ProcessModelVersion: 1
 - e. Click **Test (with inputs)**.

Importing Closed Loop Analytics Assets to Software AG Designer

Your Closed Loop Analytics installation contains the following predefined assets that enable you to develop your own customized escalation solutions:

- A pre-defined escalation process project.
- A pre-defined escalation task application project.
- An Integration Server wrapper service for the escalation process.
- Two pre-defined IS document types for triggering the process.
- A pre-defined rule project for processing escalation events.

You can import these assets into your Software AG Designer workspace so that you can customize them, as well as build and upload the escalation process project to an Integration Server.

After you import the assets, they appear in the Solutions view as well as in the Navigator view on the Software AG Designer's UI Development perspective. You can open these assets in the appropriate editor to see how they are constructed, and you can use them as templates for your customized solutions.

For more information about how to customize the escalation workflow, see [“Customizing the Escalation Workflow” on page 29](#).

To import Closed Loop Analytics assets:

1. In Software AG Designer, click **File > Import**.
 2. In the Import dialog box, do one of the following:
 - a. To import the process project and the rule project, click **General** and then **Existing Projects into Workspace**. Then click **Next**.
 - b. To import the task application project, click **Software AG** and then **Existing CAF Projects into Workspace**. Then click **Next**.
 3. Click **Browse** and navigate to this directory in your Software AG installation:
`\Solutions\ClosedLoopAnalytics\ProjectSources`
- Note:** It is recommended to keep the **Copy into workspace** option checked when importing assets.
4. Click **OK** to accept the directory and place it in the **Select root directory** field.
 5. In the Projects list, select the following projects:
 - a. To import the process project and the rule project, select `ClosedLoopAnalyticsProcessProject`, and `WmClosedLoopAnalytics` (rule project).

- b. To import the task application project, select EscalationTaskApplication.
6. Click **Finish**.

The projects appear in the Solutions view and in the Navigator view that are available in the UI Development perspective.

Upgrading a Closed Loop Analytics Installation

To upgrade your Closed Loop Analytics installation, you must migrate all components and assets involved in Closed Loop Analytics and adapt your JMS settings as described in *Upgrading Software AG Products*.

3 Reviewing Processes on the Business Process Dashboards

■ Overview	22
■ Types of Process Dashboards	22
■ Accessing the Business Process Dashboards	24

Overview



webMethods comes with three out-of-the-box Business Process dashboards that display summary metrics, instance detail, and other performance information about business processes that are under analysis by Optimize. These dashboards are displayed in either My webMethods or the webMethods Business Console, though they are rendered by an application that runs on the MashZone NextGen Server, and you must have a licensed copy of MashZone NextGen installed to use them.

Refer to *Working with Business Process Dashboards* for more information about how to install, deploy and use these dashboards.







Types of Process Dashboards









The following dashboards exist:

- **Overview Dashboard** - Displays performance metrics for a selected process for a specified time range.
- **Stage Instances Dashboard** - Displays details about the stage instances that were active during a selected time range.
- **Process Instances Dashboard** - Displays details about the process instances that were active during a selected time range.



The dashboards consist of panels. Some of the panels contain an email icon () or an escalation icon () that allow you to trigger an action if you want to escalate a problem. For more information about escalation actions, see [“Escalating Problems” on page 25](#).

The following table displays the panels of the Overview dashboard and indicates if you can send an email or start an escalation workflow from these panels.

Panel	Description	Actions
Process Volume	The Process Volume panel plots the number of process instances that completed during the selected time range.	 , 
Process Activity	The Process Activity panel reports the number of started, running, completed processes and the total number of process instances.	 , 
Process Alarms	The Process Alarms panel displays all error types that occurred during the selected time range.	 , 



Panel	Description	Actions
Process Cycle Time	The Process Cycle Time panel displays the average cycle time for the selected time range relative to the normal cycle time for this process. This panel also reports the minimum and maximum cycle times for the time range.	 , 
Stage Activity	The Stage Activity panel lists the stages associated with the process and, for each stage, reports the number of running, incomplete, and completed instances.	 , 
Stage Alarms	The Stage Alarms panel reports the number of breaches that occurred during the selected time range by stage.	 , 
Stage Cycle Times	The Stage Cycle Times panel shows the average cycle time for each stage during the selected time range relative to the normal cycle time for the stage.	 , 

The following table displays the panels of the Stage Instances dashboard and indicates if you can start an email or escalation action from these panels.

Panel	Description	Actions
Stages	The Stages panel displays the stages associated with the selected process and reports summary statistics for each.	
Stage Instances	The Stage Instances panel is displayed when you select one or more stages in the Stages panel, and it shows detailed information about the stage instances for the selected time range.	 , 

The following table displays the panels of the Process Instances dashboard and indicates if you can start an email or escalation action from these panels.

Panel	Description	Actions
Process Volume and Cycle Time	The graph in this panel plots process volume and average cycle time for the selected time range.	

Panel	Description	Actions
Process Instances	The Process Instances panel displays detailed information about instances that were active during the selected time range.	 , 

Accessing the Business Process Dashboards

You can access the dashboards from My webMethods or the webMethods Business Console.

To access the dashboards:

1. In My webMethods: **Applications > Monitoring > Business > Process Dashboards**. In the webMethods Business Console, select the **Analytics** tab.

The Overview dashboard is displayed.

2. From the tabs at the top of the page, select the dashboard you want to view.
3. From the drop-down box in the upper left hand portion of the page, select the process you want to examine.

Note: The drop-down list displays processes that are "enabled for analysis" in Optimize. If a process is not enabled for analysis, it will not appear in the list.

4. From the choices listed above the dashboard, select the time range you want to apply.

Note: The caption beneath the time-range options displays the exact start and end time of the time range you have selected or specified.

5. If you click the **Custom** button to specify a custom time range, a calendar/clock selector is displayed that enables you to specify any start and end date/time range that you wish. You can select calendar dates and times down to the minute. The time selector also contains a **Now** button that enables you to set either the start or end time to the current date/time. When a custom time range has been selected and is active, the **Custom** selection above the dashboard is highlighted.

The dashboards are updated to display the appropriate data for the specified time range.

4 Escalating Problems

■ Overview	26
■ Sending an Instant Email	26
■ About the Escalation Workflow	26

Overview

If you notice problems when reviewing process data on the Business Process dashboards, you can start an escalation action. You can:

- Send an instant email, see [“Sending an Instant Email” on page 26](#).
- Trigger a pre-defined escalation workflow that creates an escalation task, see [“About the Escalation Workflow” on page 26](#).

Sending an Instant Email

Most panels of the Business Process dashboards contain the email icon  that allows you to send an instant email when noticing a problem with the process data displayed on the panel. For an overview of all panels with the instant email action, see [“Reviewing Processes on the Business Process Dashboards” on page 21](#).

Note: Before sending instant emails, you must have configured an email account on MashZone NextGen that is used as a sender address. For more information, see [“Customizing Email Settings in MashZone NextGen” on page 13](#). Additionally, you must have configured a mail server, see [“Customizing the Optimize Email Settings” on page 14](#).

To send an instant email:

1. Click  on the panel that contains process data you want to send to other interested parties.
2. In the Send Email pop-up dialog, enter a valid recipient address in the **To** field. Optionally, you can enter a message text in the **Message** field.

Note: Note that the fields **From**, **Subject** and **Details** are pre-filled. **From** contains the sender address you configured on MashZone NextGen. **Subject** contains the name of the panel the information is sent from. **Details** contains details on the panel data.

3. Click **Send** to send the information, or **Cancel** to abort the email action.

The email is sent via the mail server you configured. The generated email includes a link that enables the recipient to view the dashboards in the state in which the email was created.

About the Escalation Workflow

Closed Loop Analytics includes a pre-defined escalation workflow. Within this escalation workflow, you can create a task that can be assigned to one or more My

webMethods Server users, enabling them to take action in response to the escalated event.

When starting the workflow, the data is passed as an EDA event to the Rules Engine via the Event Bus.

The Rules Engine:

- Receives the EDA event (external event).
- The event triggers the execution of three rules in the decision table `ProcessEscalationDecisionTable`: Set `TaskAssignee` to `Administrator` if no assignee is specified; set `DueDateOffset` to 48 hours and initialize `DueDate` if no due date is specified; and `StartEscalationProcess`.
- The `StartEscalationProcess` action sends an escalation document to the Process Engine and triggers a process instance of the process model `ProcessEscalation`.

The Process Engine:

- Receives and gets triggered by the escalation document (JMS).
- Runs an instance of the process model `ProcessEscalation`.
- Starts a user task instance of task type `EscalationTask`. It is assigned to the assignee specified by the originator of the escalation or to the assignee specified by the decision table (`Administrator`).
- If the task is completed by due date, the escalation workflow is closed. Otherwise the originator of the escalation is notified by email that the task is not completed.

The Task Engine:

- Assigns, initializes and executes a new user task instance of task type `EscalationTask`.
- The task assignee can accept and complete the task in time. Otherwise the task expires on due date.

Triggering the Escalation Workflow

Most panels of the Business Process dashboards contain the escalation icon  that enables you to trigger the pre-defined escalation workflow when noticing a problem with the process data displayed on the panel. For an overview of all panels with the escalation workflow action, see [“Reviewing Processes on the Business Process Dashboards” on page 21](#).

To trigger the escalation workflow:

1. Click .
2. In the Send `[Panel Name]` Escalation pop-up dialog, enter the name of a My webMethods user in the **Assignee User ID** field. If you do not specify an assignee, the

assignee is set to default user `Administrator` when the escalation is processed by the Rules Engine.

3. Enter a date in the **Due Date** field. If you do not specify a due date, a due date is specified when the escalation is processed by the Rules Engine.
4. (Optional) Enter a text in the **Message** field.

Note: Note that the field **Details** is pre-filled with escalation data gained from the panel.

5. Click **Send** to trigger the escalation workflow, or **Cancel** to abort the process.

The escalation workflow is started, and a user task of type `EscalationTask` is created. It includes a link back to the dashboards so the assignee can view the issue as seen on the dashboards at the time it was assigned. The assignee can view the task on the **Inbox** page in My webMethods (**Applications > Monitoring > Business > Tasks > My Inbox**), accept or reassign it and process it like any other task. You can monitor the status of these tasks and what steps were taken to address the underlying issues on the **Task** page in My webMethods or on the **Process Stream** panel on the **What's Happening Now** tab in the webMethods Business Console. Refer to *webMethods Task Engine User's Guide* and *Working with webMethods Business Console* for more information about how to process and monitor tasks.

5 Customizing the Escalation Workflow

■ Overview	30
■ Customizing the Default Escalation Process	30
■ Customizing the Default Escalation Task	32
■ Customizing the Default Rule Project	32

Overview

Closed Loop Analytics includes a pre-configured escalation workflow that can be customized according to your needs. To customize the workflow, you must import the Closed Loop Analytics assets to Software AG Designer as described in [“Importing Closed Loop Analytics Assets to Software AG Designer”](#) on page 18.

These assets include:

- A pre-defined escalation process project.
- A pre-defined escalation task application project.
- An Integration Server wrapper service for the escalation process.
- Two pre-defined IS document types for triggering the process.
- A pre-defined rule project for processing escalation events.

After you import the assets, you can open them in the appropriate editor to see how they are constructed, and you can use them as templates for your customized solutions.

Customizing the Default Escalation Process

After you import the escalation process project (ClosedLoopAnalyticsProcessProject) into your workspace, you can work with the process model on the Process Development perspective, just as you would with any process project.

Before you make any changes to the process project, you are advised to open the Navigator view, copy the project, and then paste it back into the Navigator view under a new name. If you make and save changes to the original imported project, you can always rename it and then reimport the installed process project again.

You can open the process from the Solutions view to apply changes or customizations as needed and to see how the default process is configured.

For information about working with process projects in Software AG Designer, refer to *webMethods BPM Process Development Help*.

Default Escalation Process Workflow

The default escalation process model has the following workflow.

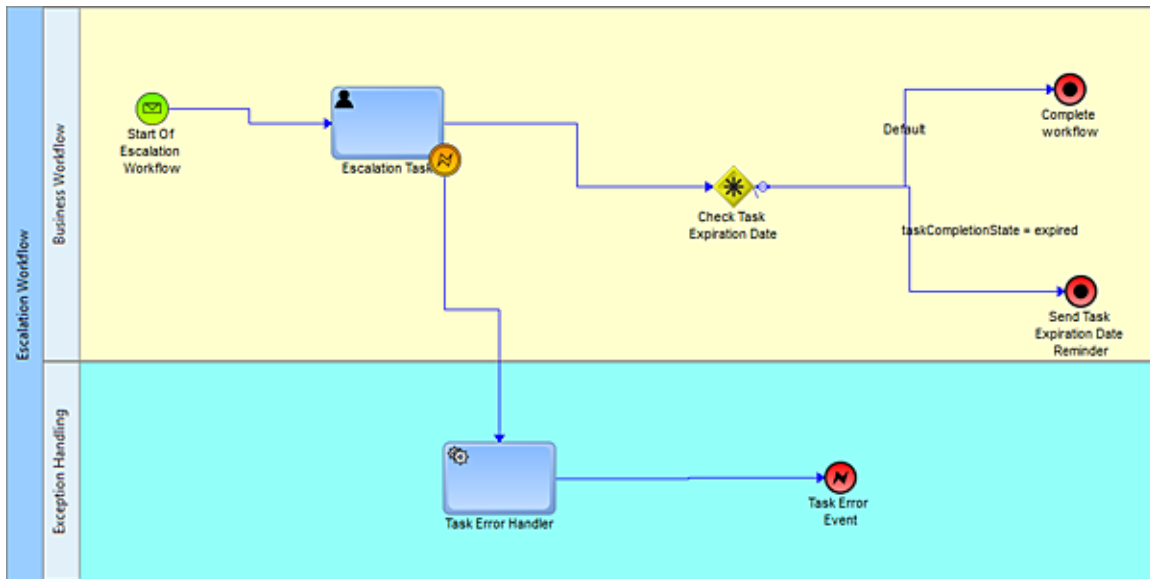

- **Start of Escalation Workflow.** This start message step is configured to receive the ProcessEscalation document type delivered as a JMS message, which triggers a new process instance. The document is published from a business rule which gets triggered by an EDA event emitted on the Business Process dashboard.
- **Escalation Task.** This escalation task is configured to process the business data in the pipeline, provided by the ProcessEscalation document type. It is configured to use the default escalation task application, EscalationTask, which must be available in My webMethods. This step requires data mapping. For more information, see *webMethods BPM Process Development Help*. The task is started by the process, and it will remain active until it reaches a defined due date (status = Expired), or if a user completes the task. Unless an error occurs, the task output transitions to the following Check Task Expiration Date step. If an error occurs, the step's intermediate boundary interrupting error event passes the error to the Task Error Handler step.
- **Check Task Expiration Date.** This complex gateway step examines the task status. If the status is Completed, the workflow transitions to the Complete workflow end terminate step. If the status is Expired, the workflow transitions to the Send Task Expiration Date Reminder end terminate step. The logic is implemented as an IF condition on the step, and on the transition to the Send Task Expiration Date Reminder end terminate step.
- **Complete workflow.** If the process completes normally, this end terminate step marks the process status as Completed.
- **Send Task Expiration Date Reminder.** If the Escalation Task status changes to Expired, this end terminate step completes the process. If you want to send an expiration notification message, you can create an appropriate document type and change this to an end message step and configure it to send the message. You will also have to create your own application to process this message. You can also choose to

implement notifications using the pre-configured task event actions in the Escalation Task.

- **Task Error Handler.** This service task step handles errors generated by the Escalation Task step. It is not configured with a target Integration Server service or web service to process the error. You must create such a service and configure this step to call it if you want to provide error handling. You can remove this step and its following end terminate step if you choose to implement notifications using the pre-configured task event actions in the Escalation Task.
- **Task Error Event.** If the Escalation Task generates an error, this end error step ends the track in the process and throws an error. If you want to send an error message, you can create an appropriate document type and change this to an end message step and configure it to send the message. You will also have to create your own application to process this message.

Customizing the Default Escalation Task

After you import the task application project (EscalationTaskApplication) into your workspace, you can work with the task application project on the UI Development perspective, just as you would with any task application project.

Before you make any changes to the project, you are advised to open the Navigator view, copy the project, and then paste it back into the Navigator view under a new name. If you make and save changes to the original imported project, you can always rename it and then reimport the installed task application again.

You can open the task from the Solutions view to apply changes or customizations as needed, and to see how the default task is configured.

For complete information about working with task applications in Software AG Designer, see the *webMethods BPM Task Development Help*.

Customizing the Default Rule Project

After you import the rule project (WmClosedLoopAnalytics) into your workspace, you can work with the rule project on the Rules Development perspective, just as you would with any rule project.

Before you make any changes to the project, you are advised to open the Navigator view, copy the project, and then paste it back into the Navigator view under a new name. If you make and save changes to the original imported project, you can always rename it and then reimport the installed rule project again.

You can open the rule project from the Solutions view to apply changes or customizations as needed, and to see how the default rule project is configured.

For complete information about working with rule projects in Software AG Designer, see the *webMethods BPM Rules Development Help*.

Default Escalation Rule Project

The default rule project processes the following data:

Originator	User ID for the individual who originated the escalation action.
OriginatorComments	Text comments added to the escalation event by the originator as well as process activity criteria (as shown in the following list) and dashboard specific process activity metrics. <ul style="list-style-type: none"> ■ Process Name: The name of the process relevant to the escalation action. ■ Process ID: The ID of the process relevant to the escalation action. ■ Start Time: The beginning time of the process data being displayed. ■ End Time: The end time of the process data being displayed.
TimestampOfCreation	The time at which the escalation action was created on the originator's computer.
TaskAssignee	User ID of the individual who is assigned a task related to the escalation action.
DueDate	Date by which the appropriate action should be completed.
RefUrl	The URL of the process dashboards for the time and state when the escalation action was generated. This URL enables the assignee to view the dashboards as the originator saw them.
ProcessName	The name of the process relevant to the escalation action.
ProcessID	The ID of the process relevant to the escalation action. The ID is composed of the folder/path and process name from Software AG Designer.

<code>StartDateRange</code>	The starting time and date as displayed on the dashboards when the escalation event was generated.
<code>EndDateRange</code>	The ending time and date as displayed on the dashboards when the escalation action was generated.
<code>EscalationType</code>	The name of the dashboard panel from which the escalation action was originated.

The following three rules are applied to the data:

- **If** `TaskAssignee=EMPTY STRING` **then set** `TaskAssignee` **to** `Administrator`.
- **If** `DueDate=NULL` **then set** `DueDate` **to** `48 [hours]` **and initialize** `GetDueDate` **action**.
- **Initialize** `StartEscalationProcess` **action**.