

# Natural

## Programming Guide

Version 6.3.13 for OpenVMS

March 2013

This document applies to Natural Version 6.3.13 for OpenVMS.

Specifications contained herein are subject to change and these changes will be reported in subsequent release notes or new editions.

Copyright © 1984-2013 Software AG, Darmstadt, Germany and/or Software AG USA, Inc., Reston, VA, United States of America, and/or their licensors.

Detailed information on trademarks and patents owned by Software AG and/or its subsidiaries is located at <http://documentation.softwareag.com/legal/>.

Use of this software is subject to adherence to Software AG's licensing conditions and terms. These terms are part of the product documentation, located at <http://documentation.softwareag.com/legal/> and/or in the root installation directory of the licensed product(s).

This software may include portions of third-party products. For third-party copyright notices and license terms, please refer to "License Texts, Copyright Notices and Disclaimers of Third-Party Products". This document is part of the product documentation, located at <http://documentation.softwareag.com/legal/> and/or in the root installation directory of the licensed product(s).

**Document ID: NATOV-NNATPROGRAMMING-6313-20130321**

## Table of Contents

Preface .....	xiii
I Natural Programming Modes .....	1
1 Natural Programming Modes .....	3
Purpose of Programming Modes .....	4
Setting/Changing the Programming Mode .....	5
Functional Differences .....	5
II Object Types .....	11
2 Using Natural Programming Objects .....	13
Types of Programming Objects .....	14
Creating and Maintaining Programming Objects .....	14
3 Data Areas .....	15
Use of Data Areas .....	16
Local Data Area .....	16
Global Data Area .....	17
Parameter Data Area .....	26
4 Programs, Functions, Subprograms and Subroutines .....	31
A Modular Application Structure .....	32
Multiple Levels of Invoked Objects .....	32
Program .....	34
Function .....	37
Subroutine .....	39
Subprogram .....	44
Processing Flow when Invoking a Routine .....	46
5 Processing a Rich GUI Page - Adapter .....	49
6 Maps .....	51
Benefits of Using Maps .....	52
Types of Maps .....	52
Creating Maps .....	53
Starting/Stopping Map Processing .....	53
7 Help routines .....	55
Invoking Help .....	56
Specifying Help routines .....	56
Programming Considerations for Help routines .....	57
Passing Parameters to Help routines .....	57
Equal Sign Option .....	58
Array Indices .....	59
Help as a Window .....	59
8 Multiple Use of Source Code - Copycode .....	61
Use of Copycode .....	62
Processing of Copycode .....	62
9 Documenting Natural Objects - Text .....	63
Use of Text Objects .....	64
Writing Text .....	64

10	Creating Component Based Applications - Class .....	65
11	Using Non-Natural Files - Resource .....	67
	Use of Resources .....	68
	Shared Resources .....	68
	Private Resources .....	69
	API for Processing Resources .....	69
III	Defining Fields .....	71
12	Use and Structure of DEFINE DATA Statement .....	73
	Field Definitions in DEFINE DATA Statement .....	74
	Defining Fields within a DEFINE DATA Statement .....	74
	Defining Fields in a Separate Data Area .....	75
	Structuring a DEFINE DATA Statement Using Level Numbers .....	75
13	User-Defined Variables .....	79
	Definition of Variables .....	80
	Referencing of Database Fields Using (r) Notation .....	81
	Renumbering of Source-Code Line Number References .....	82
	Format and Length of User-Defined Variables .....	83
	Special Formats .....	84
	Index Notation .....	86
	Referencing a Database Array .....	89
	Referencing the Internal Count for a Database Array (C* Notation) .....	97
	Qualifying Data Structures .....	100
	Examples of User-Defined Variables .....	101
14	Function Call .....	103
	Calling User-Defined Functions .....	104
	Function Result .....	105
	Evaluation Sequence .....	105
	Restrictions .....	105
	Syntax Description .....	106
	Example .....	110
15	Introduction to Dynamic Variables and Fields .....	115
	Purpose of Dynamic Variables .....	116
	Definition of Dynamic Variables .....	116
	Value Space Currently Used for a Dynamic Variable .....	117
	Size Limitation Check .....	117
	Allocating/Freeing Memory Space for a Dynamic Variable .....	118
16	Using Dynamic and Large Variables .....	121
	General Remarks .....	122
	Assignments with Dynamic Variables .....	123
	Initialization of Dynamic Variables .....	125
	String Manipulation with Dynamic Alphanumeric Variables .....	125
	Logical Condition Criterion (LCC) with Dynamic Variables .....	126
	AT/IF-BREAK of Dynamic Control Fields .....	128
	Parameter Transfer with Dynamic Variables .....	128
	Work File Access with Large and Dynamic Variables .....	131

DDM Generation and Editing for Varying Length Columns .....	132
Accessing Large Database Objects .....	134
Performance Aspects with Dynamic Variables .....	135
Outputting Dynamic Variables .....	136
Dynamic X-Arrays .....	137
17 User-Defined Constants .....	139
Numeric Constants .....	140
Alphanumeric Constants .....	141
Unicode Constants .....	142
Date and Time Constants .....	145
Hexadecimal Constants .....	146
Logical Constants .....	148
Floating Point Constants .....	148
Attribute Constants .....	149
Handle Constants .....	150
Defining Named Constants .....	150
18 Initial Values (and the RESET Statement) .....	153
Default Initial Value of a User-Defined Variable/Array .....	154
Assigning an Initial Value to a User-Defined Variable/Array .....	154
Resetting a User-Defined Variable to its Initial Value .....	156
19 Redefining Fields .....	159
Using the REDEFINE Option of DEFINE DATA .....	160
Example Program Illustrating the Use of a Redefinition .....	161
20 Arrays .....	163
Defining Arrays .....	164
Initial Values for Arrays .....	165
Assigning Initial Values to One-Dimensional Arrays .....	165
Assigning Initial Values to Two-Dimensional Arrays .....	166
A Three-Dimensional Array .....	170
Arrays as Part of a Larger Data Structure .....	172
Database Arrays .....	173
Using Arithmetic Expressions in Index Notation .....	173
Arithmetic Support for Arrays .....	174
21 X-Arrays .....	177
Definition .....	178
Storage Management of X-Arrays .....	179
Storage Management of X-Group Arrays .....	179
Referencing an X-Array .....	181
Parameter Transfer with X-Arrays .....	182
Parameter Transfer with X-Group Arrays .....	183
X-Array of Dynamic Variables .....	184
Lower and Upper Bound of an Array .....	185
IV User-Defined Functions .....	187
22 User-Defined Functions .....	189
Introduction to User-Defined Functions .....	190

Restrictions .....	191
Function Call versus Subprogram Call .....	191
Function Definition (DEFINE FUNCTION) .....	194
Symbolic and Variable Function Call .....	194
Function Result and Parameters .....	194
Explicit Prototype Definition (DEFINE PROTOTYPE) .....	195
Implicit (Automatic) Prototype Definition .....	195
Prototype Cast (PT Clause) .....	196
Intermediate Result Definition (IR Clause) .....	196
Combinations of Possible Prototype Definitions .....	196
Evaluation Sequence of Functions in Statements .....	198
Using a Function as a Statement .....	200
V Accessing Data in a Database .....	203
23 Natural and Database Access .....	205
Database Management Systems Supported by Natural .....	206
Profile Parameters Influencing Database Access .....	206
Access through Data Definition Modules .....	206
Natural's Data Manipulation Language .....	207
Natural's Special SQL Statements .....	208
24 Accessing Data in an Adabas Database .....	209
Adabas Database Management Interfaces ADA and ADA2 .....	210
Data Definition Modules - DDMs .....	210
Database Arrays .....	212
Defining a Database View .....	217
Statements for Database Access .....	220
Multi-Fetch Clause .....	232
Database Processing Loops .....	233
Database Update - Transaction Processing .....	239
Selecting Records Using ACCEPT/REJECT .....	246
AT START/END OF DATA Statements .....	250
Unicode Data .....	252
VI Controlling Data Output .....	253
25 Report Specification - (rep) Notation .....	255
Use of Report Specifications .....	256
Statements Concerned .....	256
Examples of Report Specification .....	256
26 Layout of an Output Page .....	257
Statements Influencing a Report Layout .....	258
General Layout Example .....	258
27 Statements DISPLAY and WRITE .....	261
DISPLAY Statement .....	262
WRITE Statement .....	263
Example of DISPLAY Statement .....	264
Example of WRITE Statement .....	264
Column Spacing - SF Parameter and nX Notation .....	265

Tab Setting - nT Notation .....	266
Line Advance - Slash Notation .....	267
Further Examples of DISPLAY and WRITE Statements .....	270
28 Index Notation for Multiple-Value Fields and Periodic Groups .....	271
Use of Index Notation .....	272
Example of Index Notation in DISPLAY Statement .....	272
Example of Index Notation in WRITE Statement .....	273
29 Page Titles, Page Breaks, Blank Lines .....	275
Default Page Title .....	276
Suppress Page Title - NOTITLE Option .....	276
Define Your Own Page Title - WRITE TITLE Statement .....	277
Logical Page and Physical Page .....	280
Page Size - PS Parameter .....	282
Page Advance .....	282
New Page with Title .....	285
Page Trailer - WRITE TRAILER Statement .....	286
Generating Blank Lines - SKIP Statement .....	288
AT TOP OF PAGE Statement .....	289
AT END OF PAGE Statement .....	290
Further Example .....	292
30 Column Headers .....	293
Default Column Headers .....	294
Suppress Default Column Headers - NOHDR Option .....	294
Define Your Own Column Headers .....	295
Combining NOTITLE and NOHDR .....	296
Centering of Column Headers - HC Parameter .....	296
Width of Column Headers - HW Parameter .....	296
Filler Characters for Headers - Parameters FC and GC .....	297
Underlining Character for Titles and Headers - UC Parameter .....	298
Suppressing Column Headers - Slash Notation .....	299
Further Examples of Column Headers .....	300
31 Parameters to Influence the Output of Fields .....	301
Overview of Field-Output-Relevant Parameters .....	302
Leading Characters - LC Parameter .....	302
Unicode Leading Characters - LCU Parameter .....	303
Insertion Characters - IC Parameter .....	303
Unicode Insertion Characters - ICU Parameter .....	304
Trailing Characters - TC Parameter .....	304
Unicode Trailing Characters - TCU Parameter .....	304
Output Length - AL and NL Parameters .....	305
Display Length for Output - DL Parameter .....	305
Sign Position - SG Parameter .....	307
Identical Suppress - IS Parameter .....	309
Zero Printing - ZP Parameter .....	311
Empty Line Suppression - ES Parameter .....	311

Further Examples of Field-Output-Relevant Parameters .....	313
32 Code Page Edit Masks - EM Parameter .....	315
Use of EM Parameter .....	316
Edit Masks for Numeric Fields .....	316
Edit Masks for Alphanumeric Fields .....	317
Length of Fields .....	317
Edit Masks for Date and Time Fields .....	318
Customizing Separator Character Displays .....	318
Examples of Edit Masks .....	320
Further Examples of Edit Masks .....	322
33 Unicode Edit Masks - EMU Parameter .....	323
34 Vertical Displays .....	325
Creating Vertical Displays .....	326
Combining DISPLAY and WRITE .....	326
Tab Notation - T*field .....	327
Positioning Notation x/y .....	328
DISPLAY VERT Statement .....	329
Further Example of DISPLAY VERT with WRITE Statement .....	335
VII Further Programming Aspects .....	337
35 End of Statement, Program or Application .....	339
End of Statement .....	340
End of Program .....	340
End of Application .....	340
36 Processing of Application Errors .....	343
Natural's Default Error Processing .....	344
Application Specific Error Processing .....	344
Using an ON ERROR Statement Block .....	345
Using an Error Transaction Program .....	346
Error Processing Related Features .....	349
37 Conditional Processing - IF Statement .....	353
Structure of IF Statement .....	354
Nested IF Statements .....	356
38 Loop Processing .....	359
Use of Processing Loops .....	360
Limiting Database Loops .....	360
Limiting Non-Database Loops - REPEAT Statement .....	362
Example of REPEAT Statement .....	363
Terminating a Processing Loop - ESCAPE Statement .....	364
Loops Within Loops .....	364
Example of Nested FIND Statements .....	364
Referencing Statements within a Program .....	365
Example of Referencing with Line Numbers .....	367
Example with Statement Reference Labels .....	368
39 Control Breaks .....	371
Use of Control Breaks .....	372



AT BREAK Statement .....	372
Automatic Break Processing .....	377
Example of System Functions with AT BREAK Statement .....	378
Further Example of AT BREAK Statement .....	380
BEFORE BREAK PROCESSING Statement .....	380
Example of BEFORE BREAK PROCESSING Statement .....	380
User-Initiated Break Processing - PERFORM BREAK PROCESSING Statement .....	381
Example of PERFORM BREAK PROCESSING Statement .....	383
40 Data Computation .....	385
COMPUTE Statement .....	386
Statements MOVE and COMPUTE .....	387
Statements ADD, SUBTRACT, MULTIPLY and DIVIDE .....	388
Example of MOVE, SUBTRACT and COMPUTE Statements .....	388
COMPRESS Statement .....	389
Example of COMPRESS and MOVE Statements .....	390
Example of COMPRESS Statement .....	391
Mathematical Functions .....	392
Further Examples of COMPUTE, MOVE and COMPRESS Statements .....	393
41 System Variables and System Functions .....	395
System Variables .....	396
System Functions .....	397
Example of System Variables and System Functions .....	398
Further Examples of System Variables .....	399
Further Examples of System Functions .....	400
42 Stack .....	401
Use of Natural Stack .....	402
Stack Processing .....	402
Placing Data on the Stack .....	403
Clearing the Stack .....	404
43 Processing of Date Information .....	405
Edit Masks for Date Fields and Date System Variables .....	406
Default Edit Mask for Date - DTFORM Parameter .....	406
Date Format for Alphanumeric Representation - DF Parameter .....	407
Date Format for Output - DFOUT Parameter .....	409
Date Format for Stack - DFSTACK Parameter .....	410
Year Sliding Window - YSLW Parameter .....	411
Combinations of DFSTACK and YSLW .....	413
Year Fixed Window .....	415
Date Format for Default Page Title - DFTITLE Parameter .....	415
44 Text Notation .....	417
Defining a Text to Be Used with a Statement - the 'text' Notation .....	418
Defining a Character to Be Displayed n Times before a Field Value - the 'c'(n) Notation .....	419
45 User Comments .....	421

Using an Entire Source Code Line for Comments .....	422
Using the Latter Part of a Source Code Line for Comments .....	423
46 Logical Condition Criteria .....	425
Introduction .....	426
Relational Expression .....	427
Extended Relational Expression .....	431
Evaluation of a Logical Variable .....	432
Fields Used within Logical Condition Criteria .....	433
Logical Operators in Complex Logical Expressions .....	435
BREAK Option - Compare Current Value with Value of Previous Loop Pass .....	436
IS Option - Check whether Content of Alphanumeric or Unicode Field can be Converted .....	438
MASK Option - Check Selected Positions of a Field for Specific Content .....	440
MASK Option Compared with IS Option .....	447
MODIFIED Option - Check whether Field Content has been Modified .....	449
SCAN Option - Scan for a Value within a Field .....	450
SPECIFIED Option - Check whether a Value is Passed for an Optional Parameter .....	452
47 Rules for Arithmetic Assignment .....	455
Field Initialization .....	456
Data Transfer .....	456
Field Truncation and Field Rounding .....	459
Result Format and Length in Arithmetic Operations .....	459
Arithmetic Operations with Floating-Point Numbers .....	460
Arithmetic Operations with Date and Time .....	462
Performance Considerations for Mixed Format Expressions .....	466
Precision of Results of Arithmetic Operations .....	466
Error Conditions in Arithmetic Operations .....	467
Processing of Arrays .....	468
48 Invoking Natural Subprograms from 3GL Programs .....	475
Passing Parameters from the 3GL Program to the Subprogram .....	476
Example of Invoking a Natural Subprogram from a 3GL Program .....	477
49 Issuing Operating System Commands from within a Natural Program .....	479
Syntax .....	480
Parameters .....	480
Parameter Options .....	480
Return Codes .....	481
Examples .....	481
50 Statements for Internet and XML Access .....	483
Statements Available .....	484
Further References .....	485
VIII Portable Natural Generated Programs .....	487
51 Portable Natural Generated Programs .....	489
Compatibility .....	490

Endian Mode Considerations .....	490
ENDIAN Parameter .....	491
Portable FILEDIR.SAG and Error Message Files .....	491
IX Designing Application User Interfaces .....	493
52 Screen Design .....	495
Control of Function-Key Lines - Terminal Command %Y .....	496
Control of the Message Line - Terminal Command %M .....	498
Assigning Colors to Fields - Terminal Command %= .....	498
Infoline - Terminal Command %X .....	499
Windows .....	500
Standard/Dynamic Layout Maps .....	509
Multilingual User Interfaces .....	509
Skill-Sensitive User Interfaces .....	513
53 Dialog Design .....	515
Field-Sensitive Processing .....	516
Simplifying Programming .....	518
Line-Sensitive Processing .....	519
Column-Sensitive Processing .....	520
Processing Based on Function Keys .....	520
Processing Based on Function-Key Names .....	521
Processing Data Outside an Active Window .....	522
Copying Data from a Screen .....	525
Statements REINPUT/REINPUT FULL .....	528
X .....	531
54 Natural Reserved Keywords .....	533
Alphabetical List of Natural Reserved Keywords .....	534
Performing a Check for Natural Reserved Keywords .....	549
55 Referenced Example Programs .....	551
READ Statement .....	552
FIND Statement .....	553
Nested READ and FIND Statements .....	557
ACCEPT and REJECT Statements .....	559
AT START OF DATA and AT END OF DATA Statements .....	561
DISPLAY and WRITE Statements .....	564
DISPLAY Statement .....	568
Column Headers .....	569
Field-Output-Relevant Parameters .....	571
Edit Masks .....	577
DISPLAY VERT with WRITE Statement .....	580
AT BREAK Statement .....	581
COMPUTE, MOVE and COMPRESS Statements .....	582
System Variables .....	585
System Functions .....	588



---

# Preface

---

This guide is complementary to the Natural reference documentation in that it provides basic information and some longer, in-depth articles on various aspects of programming with Natural. You should be familiar with this information before you start to write Natural applications.

## Natural Programming Modes

Describes the differences between the two Natural programming modes: Reporting Mode and Structured Mode.

Generally, it is recommended to use structured mode exclusively, because it provides for more clearly structured applications. Therefore, all explanations and examples in this documentation refer to structured mode. Any peculiarities of reporting mode will not be taken into consideration.

## Object Types

Within an application, you can use several types of programming objects to achieve an efficient application structure. This document discusses the various types of Natural programming objects, such as data areas, programs, subprograms, subroutines, help routines, maps.

## Defining Fields

Describes how you define the fields you wish to use in a program.

## User-Defined Functions

Explains the benefits of using the Natural programming object “function”, shows the difference between using function calls and subprogram calls and describes the methods available for defining and calling a function.

## Accessing Data in a Database

Describes various aspects of using Natural to access data in an Adabas database.

## Controlling Data Output

Discusses various aspects of how you can control the format of an output report created with Natural, that is, the way in which the data are displayed.

## Further Programming Aspects

Discusses various other aspects of programming with Natural.

## Portable Natural Generated Programs

As of Natural 5, generated programs are portable across the platforms UNIX, OpenVMS and Windows.

## Designing Application User Interfaces

Provides information on components of Natural which you can use to design character-based user interfaces for your applications.

## Natural Reserved Keywords

Contains a list of all keywords and words that are reserved in the Natural programming language.

## Referenced Example Programs

The preceding sections of the *Programming Guide* contain several examples of Natural programs. In addition, links are provided there to further example programs (mainly for reporting mode) which are contained in this separate section.

### Note:

1. All example programs shown in the *Programming Guide* are also provided in source-code form in the Natural library SYSEXP. The example programs use data from the files EMPLOYEES and VEHICLES, which are supplied by

Software AG for demonstration purposes. The Natural library SYSEXPB also includes example programs for *Natural Functions*.

2. Further example programs of using Natural statements are provided in the Natural library SYSEXSYN and are documented in the section *Referenced Example Programs* in the *Statements* documentation.
3. Please ask your Natural administrator about the availability of the libraries SYSEXPB and SYSEXSYN at your site.
4. To use any Natural example program to access an Adabas database, the Adabas nucleus parameter `OPTIONS` must be set to `TRUNCATION`.

**Notation** *vrs* or *vr*

When used in this documentation, the notation *vrs* or *vr* represents the relevant product version (see also *Version* in the *Glossary*).

# I Natural Programming Modes

---





# 1 Natural Programming Modes

---

▪ Purpose of Programming Modes .....	4
▪ Setting/Changing the Programming Mode .....	5
▪ Functional Differences .....	5

## Purpose of Programming Modes

---

Natural offers two ways of programming:

- [Reporting Mode](#)
- [Structured Mode](#)



**Note:** Generally, it is recommended to use structured mode exclusively, because it provides for more clearly structured applications.

### Reporting Mode

Reporting mode is only useful for the creation of adhoc reports and small programs which do not involve complex data and/or programming constructs. (If you decide to write a program in reporting mode, be aware that small programs may easily become larger and more complex.)

Please note that certain Natural statements are available only in reporting mode, whereas others have a specific structure when used in reporting mode. For an overview of the statements that can be used in reporting mode, see *Reporting Mode Statements* in the *Statements* documentation.

### Structured Mode

Structured mode is intended for the implementation of complex applications with a clear and well-defined program structure. The major benefits of structured mode are:

- The programs have to be written in a more structured way and are therefore easier to read and consequently easier to maintain.
- As all fields to be used in a program have to be defined in one central location (instead of being scattered all over the program, as is possible in reporting mode), overall control of the data used is much easier.

With structured mode, you also have to make more detail planning before the actual programs can be coded, thereby avoiding many programming errors and inefficiencies.

For an overview of the statements that can be used in structured mode, see *Statements Grouped by Functions* in the *Statements* documentation.

## Setting/Changing the Programming Mode

The default programming mode is set by the Natural administrator with the profile parameter SM.

For further information on the Natural profile and session parameter SM, see *SM - Programming in Structured Mode* in the *Parameter Reference*.

For information on how to change the programming mode, see *SM - Programming in Structured Mode* in the *Parameter Reference*.

## Functional Differences

The following major functional differences exist between reporting mode and structured mode:

- [Syntax Related to Closing Loops and Functional Blocks](#)
- [Closing a Processing Loop in Reporting Mode](#)
- [Closing a Processing Loop in Structured Mode](#)
- [Location of Data Elements in a Program](#)
- [Database Reference](#)



**Note:** For detailed information on functional differences that exist between the two modes, see the *Statements* documentation. It provides separate syntax diagrams and syntax element descriptions for each mode-sensitive statement. For a functional overview of the statements that can be used in reporting mode, see *Reporting Mode Statements* in the *Statements* documentation.

### Syntax Related to Closing Loops and Functional Blocks

<b>Reporting Mode:</b>	(CLOSE) LOOP and DO . . . DOEND statements are used for this purpose.  END- . . . statements (except END-DEFINE, END-DECIDE and END-SUBROUTINE) cannot be used.
<b>Structured Mode:</b>	Every loop or logical construct must be explicitly closed with a corresponding END- . . . statement. Thus, it becomes immediately clear, which loop/logical constructs ends where.  LOOP and DO/DOEND statements cannot be used.

The two examples below illustrate the differences between the two modes in constructing processing loops and logical conditions.

### Reporting Mode Example:

The reporting mode example uses the statements `DO` and `DOEND` to mark the beginning and end of the statement block that is based on the `AT END OF DATA` condition. The `END` statement closes all active processing loops.

```
READ EMPLOYEES BY PERSONNEL-ID
DISPLAY NAME BIRTH
AT END OF DATA
  DO
    SKIP 2
    WRITE / 'LAST SELECTED:' OLD(NAME)
  DOEND
END
```

### Structured Mode Example:

The structured mode example uses an `END-ENDDATA` statement to close the `AT END OF DATA` condition, and an `END-READ` statement to close the `READ` loop. The result is a more clearly structured program in which you can see immediately where each construct begins and ends:

```
DEFINE DATA LOCAL
1 MYVIEW VIEW OF EMPLOYEES
  2 PERSONNEL-ID
  2 NAME
  2 BIRTH

END-DEFINE
READ MYVIEW BY PERSONNEL-ID
  DISPLAY NAME BIRTH
  AT END OF DATA
    SKIP 2
    WRITE / 'LAST SELECTED:' OLD(NAME)
  END-ENDDATA
END-READ
END
```

### Closing a Processing Loop in Reporting Mode

The statements `END`, `LOOP` (or `CLOSE LOOP`) or `SORT` may be used to close a processing loop.

The `LOOP` statement can be used to close more than one loop, and the `END` statement can be used to close all active loops. These possibilities of closing several loops with a single statement constitute a basic difference to structured mode.

A `SORT` statement closes all processing loops and initiates another processing loop.

**Example 1 - LOOP:**

```

FIND ...
  FIND ...
  ...
  ...
  LOOP      /* closes inner FIND loop
LOOP      /* closes outer FIND loop
...
...

```

**Example 2 - END:**

```

FIND ...
  FIND ...
  ...
  ...
END          /* closes all loops and ends processing

```

**Example 3 - SORT:**

```

FIND ...
  FIND ...
  ...
  ...
SORT ...      /* closes all loops, initiates loop
...
END          /* closes SORT loop and ends processing

```

**Closing a Processing Loop in Structured Mode**

Structured mode uses a specific loop-closing statement for each processing loop. Also, the `END` statement does not close any processing loop. The `SORT` statement must be preceded by an `END-ALL` statement, and the `SORT` loop must be closed with an `END-SORT` statement.

**Example 1 - FIND:**

```

FIND ...
  FIND ...
  ...
  ...
  END-FIND  /* closes inner FIND loop
END-FIND  /* closes outer FIND loop
...

```

### Example 2 - READ:

```
READ ...
  AT END OF DATA
  ...
  END-ENDDATA
  ...
END-READ          /* closes READ loop
...
...
END
```

### Example 3 - SORT:

```
READ ...
  FIND ...
  ...
  ...
END-ALL          /* closes all loops
SORT            /* opens loop
...
...
END-SORT        /* closes SORT loop
END
```

## Location of Data Elements in a Program

In reporting mode, you can use database fields without having to define them in a `DEFINE DATA` statement; also, you can define user-defined variables anywhere in a program, which means that they can be scattered all over the program.

In structured mode, *all* data elements to be used have to be defined in one central location (either in the `DEFINE DATA` statement at the beginning of the program, or in a data area outside the program).

## Database Reference

### Reporting Mode:

In reporting mode, database fields and data definition modules (DDMs) may be referenced without having been defined in a [data area](#).

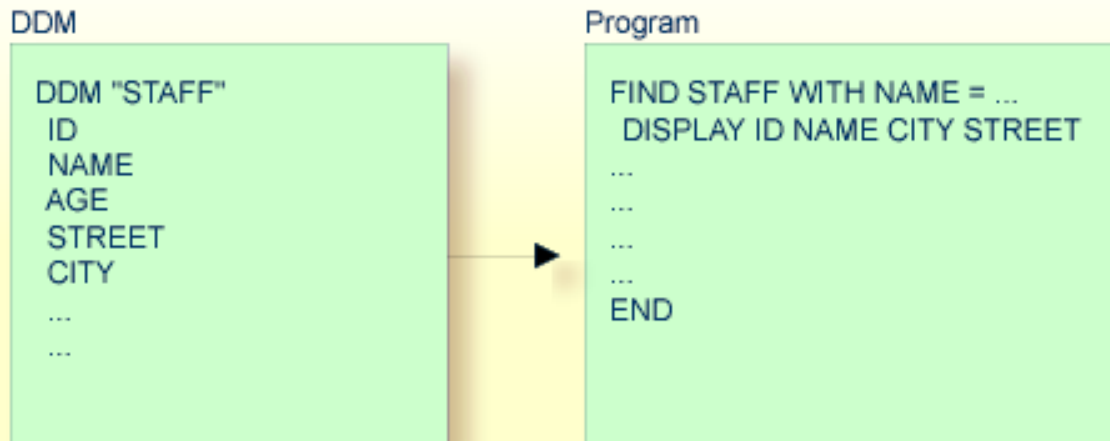

### Structured Mode:

In structured mode, each database field to be used must be specified in a `DEFINE DATA` statement as described in *Defining Fields* and *Accessing Data in an Adabas Database*.

DDM

```
DDM "STAFF"  
ID  
NAME  
AGE  
STREET  
CITY  
...  
...
```



Program

```
DEFINE DATA LOCAL  
1 VIEWXYZ VIEW OF STAFF  
2 ID  
2 NAME  
2 AGE  
2 STREET  
2 CITY  
END-DEFINE  
*  
FIND VIEWXYZ WITH NAME = ...  
  DISPLAY ID NAME CITY STREET  
...  
...  
END-FIND  
...  
END
```



# II

## Object Types

---

This part describes the various types of Natural programming objects that can be used to achieve an efficient application structure. All Natural objects are stored in Natural libraries. Natural libraries are contained in Natural system files.

[Using Natural Programming Objects](#)

[Data Areas](#)

[Programs, Functions, Subprograms and Subroutines](#)

[Processing a Rich GUI Page - Adapter](#)

[Maps](#)

[Help routines](#)

[Multiple Use of Source Code - Copycode](#)

[Documenting Natural Objects - Text](#)

[Creating Component Based Applications - Class](#)

[Using Non-Natural Files - Resource](#)



# 2 Using Natural Programming Objects

---

- Types of Programming Objects ..... 14
- Creating and Maintaining Programming Objects ..... 14

## Types of Programming Objects

---

Within a Natural application, you can use the following types of programming objects:

- **Program**
- **Class**
- **Subprogram**
- **Function**
- **Adapter**
- **Subroutine**
- **Copycode**
- **Helproutine**
- **Text**
- **Map**
- **Local Data Area**
- **Global Data Area**
- **Parameter Data Area**
- **Resource**

## Creating and Maintaining Programming Objects

---

To create and maintain the programming objects, you use the NaturalONE editors.

- Programs, subprograms, subroutines, functions, copycodes, helproutines, texts, global data areas, local data areas and parameter data areas are created and maintained with the source editor.
- Character-based user interface maps are created and maintained with the map editor.  
  
Complex graphical user interfaces are created and maintained with the Ajax Developer.
- Data definition modules (DDM) are created and maintained with the DDM editor.

# 3 Data Areas

---

- Use of Data Areas ..... 16
- Local Data Area ..... 16
- Global Data Area ..... 17
- Parameter Data Area ..... 26

## Use of Data Areas

---

As explained in *Defining Fields*, all fields that are to be used in a program have to be defined in a `DEFINE DATA` statement.

The fields can be defined within the `DEFINE DATA` statement itself; or they can be defined outside the program in a separate data area, with the `DEFINE DATA` statement referencing that data area.

A separate data area is a Natural object that can be used by multiple Natural programs, subprograms, subroutines, help routines or classes. A data area contains data element definitions, such as user-defined variables, constants and database fields from a data definition module (DDM).

All data areas are created and edited with the source editor.

Natural supports three types of data area:

- **Local Data Area**
- **Global Data Area**
- **Parameter Data Area**

## Local Data Area

---

Variables defined as local are used only within a single Natural programming object. There are two options for defining local data:

- Define local data within a program.
- Define local data outside a program in a separate Natural programming object, a local data area (LDA).

Such a local data area is initialized when a program, subprogram or external subroutine that uses this local data area starts to execute.

For a clear application structure and for easier maintainability, it is usually better to define fields in data areas outside the programs.

### **Example 1 - Fields Defined Directly within a `DEFINE DATA` Statement:**

In the following example, the fields are defined directly within the `DEFINE DATA` statement of the program.

```

DEFINE DATA LOCAL
1 VIEWEMP VIEW OF EMPLOYEES
  2 NAME
  2 FIRST-NAME
  2 PERSONNEL-ID
1 #VARI-A (A20)
1 #VARI-B (N3.2)
1 #VARI-C (I4)
END-DEFINE
...

```

### Example 2 - Fields Defined in a Separate Data Area:

In the following example, the same fields are not defined in the `DEFINE DATA` statement of the program, but in an LDA, named `LDA39`, and the `DEFINE DATA` statement in the program contains only a reference to that data area.

Program:

```

DEFINE DATA LOCAL
  USING LDA39
END-DEFINE
...

```

Local Data Area LDA39:

I T L	Name	F Length	Miscellaneous
All	----->	----->	----->
V 1	VIEWEMP		EMPLOYEES
2	PERSONNEL-ID	A	8
2	FIRST-NAME	A	20
2	NAME	A	20
1	#VARI-A	A	20
1	#VARI-B	N	3.2
1	#VARI-C	I	4

## Global Data Area

The following topics are covered below:

- [Creating and Referencing a GDA](#)
- [Creating and Deleting GDA Instances](#)

- [Data Blocks](#)

## Creating and Referencing a GDA

GDAs are created and modified with the source editor.

A GDA that is referenced by a Natural programming object must be stored in the same Natural library (or a steplib defined for this library) where the object that references this GDA is stored.



**Note:** Using a GDA named `COMMON` for startup:

If a GDA named `COMMON` exists in a library, the program named `ACOMMON` is invoked automatically when you `LOGON` to that library.



**Important:** When you build an application where multiple Natural programming objects reference a GDA, remember that modifications to the data element definitions in the GDA affect all Natural programming objects that reference that data area. Therefore these objects must be recompiled (cataloged and stowed) after the GDA has been modified.

To use a GDA, a Natural programming object must reference it with the `GLOBAL` clause of the `DEFINE DATA` statement. Each Natural programming object can reference only one GDA; that is, a `DEFINE DATA` statement must not contain more than one `GLOBAL` clause.

## Creating and Deleting GDA Instances

The first instance of a GDA is created and initialized at runtime when the first Natural programming object that references it starts to execute.

Once a GDA instance has been created, the data values it contains can be shared by all Natural programming objects that reference this GDA (`DEFINE DATA GLOBAL` statement) and that are invoked by a `PERFORM`, `INPUT` or `FETCH` statement. All objects that share a GDA instance are operating on the same data elements.

A new GDA instance is created if the following applies:

- A subprogram that references a GDA (*any* GDA) is invoked with a `CALLNAT` statement.
- A subprogram that does *not* reference a GDA invokes a programming object that references a GDA (*any* GDA).

If a new instance of a GDA is created, the current GDA instance is suspended and the data values it contains are stacked. The subprogram then references the data values in the newly created GDA instance. The data values in the suspended GDA instance or instances is inaccessible. A programming object only refers to one GDA instance and cannot access any previous GDA instances. A GDA data element can only be passed to a subprogram by defining the element as a parameter in the `CALLNAT` statement.



When the subprogram returns to the invoking programming object, the GDA instance it references is deleted and the GDA instance suspended previously is resumed with its data values.

A GDA instance and its contents is deleted if any of the following applies:

- The next `LOGON` is performed.
- Another GDA is referenced on the same level (levels are described later in this section).
- A `RELEASE VARIABLES` statement is executed. In this case, the data values in a GDA instance are reset either when a program at the level 1 finishes executing, or if the program invokes another program via a `FETCH` or `RUN` statement.

The following graphics illustrate how programming objects reference GDAs and share data elements in GDA instances.

### Sharing GDA Instances

The graphic below illustrates that a subprogram referencing a GDA cannot share the data values in a GDA instance referenced by the invoking program. A subprogram that references the same GDA as the invoking program creates a new instance of this GDA. The data elements defined in a GDA that is referenced by a subprogram can, however, be shared by a subroutine or a help routine invoked by the subprogram.

The graphic below shows three GDA instances of `GDA1` and the final values each GDA instance is assigned by the data element `#GLOB1`. The numbers ① to ⑦ indicate the hierarchical levels of the programming objects.

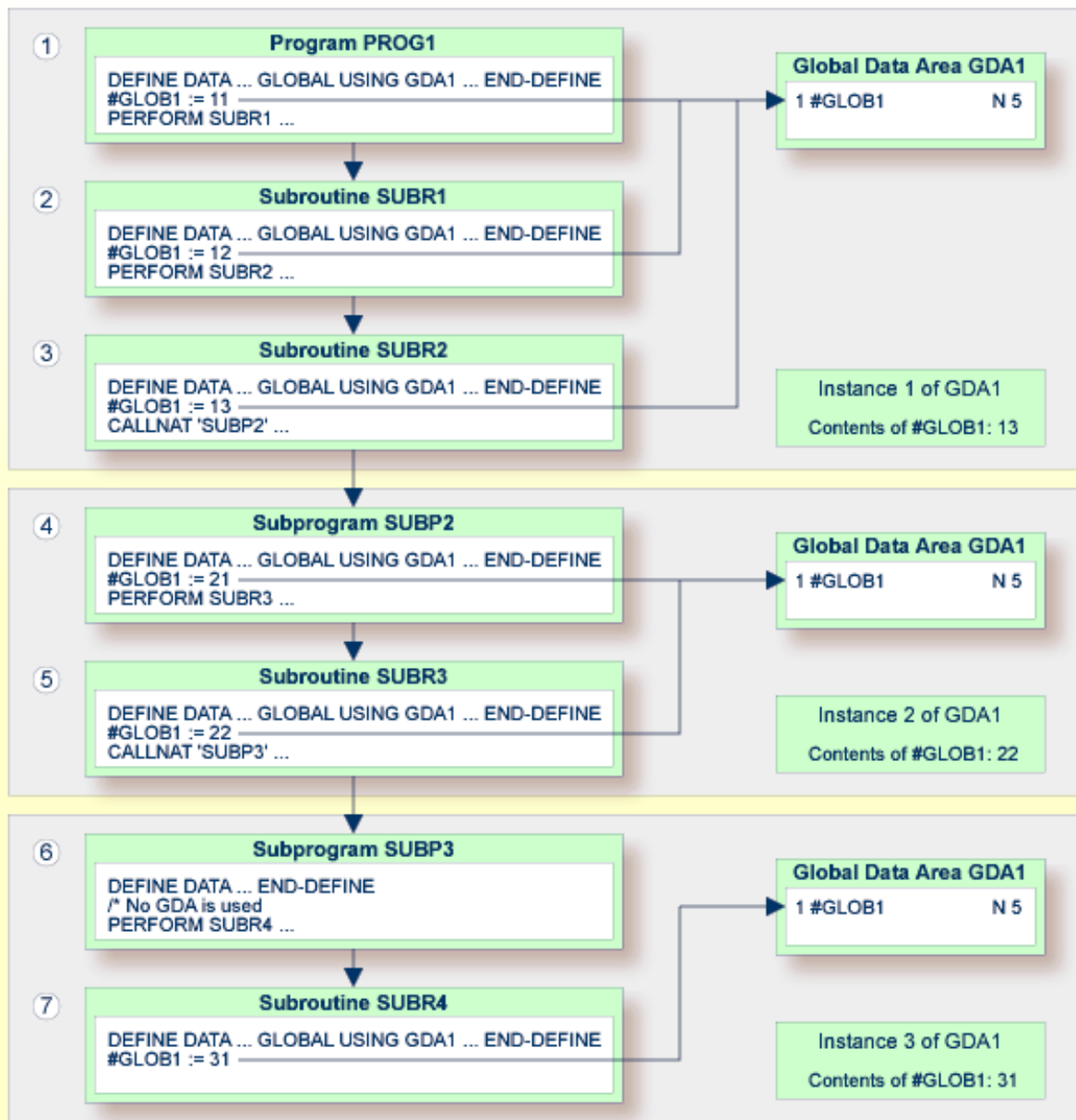

### Using FETCH or FETCH RETURN

The graphic below illustrates that programs referencing the same GDA and invoking one another with the `FETCH` or `FETCH RETURN` statement share the data elements defined in this GDA. If any of these programs does not reference a GDA, the instance of the GDA referenced previously remains active and the values of the data elements are retained.

The numbers ① and ② indicate the hierarchical levels of the programming objects.

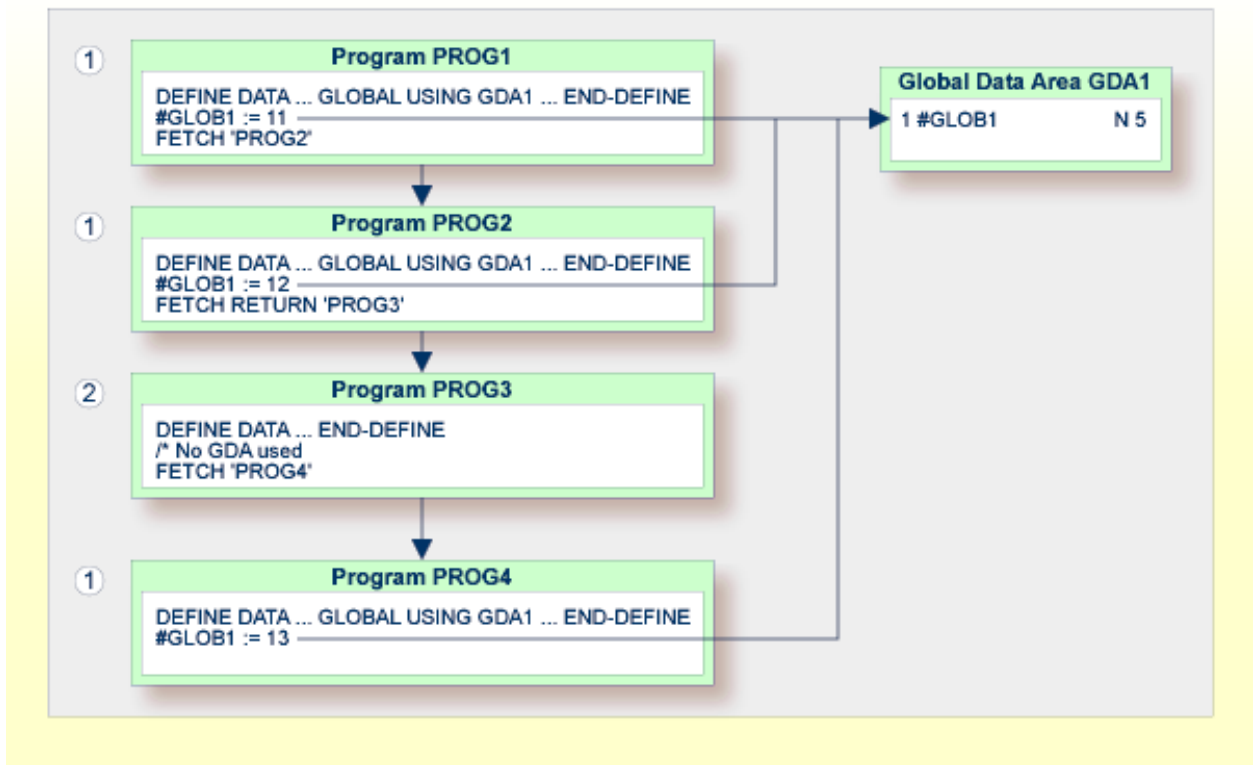

### Using FETCH with different GDAs

The graphic below illustrates that if a program uses the `FETCH` statement to invoke another program that references a different GDA, the current instance of the GDA (here: GDA1) referenced by the invoking program is deleted. If this GDA is then referenced again by another program, a new instance of this GDA is created where all data elements have their initial values.

You cannot use the `FETCH RETURN` statement to invoke another program that references a different GDA.

The number **①** indicates the hierarchical level of the programming objects.

The invoking programs `PROG3` and `PROG4` affect the GDA instances as follows:

- The statement `GLOBAL USING GDA2` in `PROG3` creates an instance of GDA2 and deletes the current instance of GDA1.
- The statement `GLOBAL USING GDA1` in `PROG4` deletes the current instance of GDA2 and creates a new instance of GDA1. As a result, the `WRITE` statement displays the value zero (0).

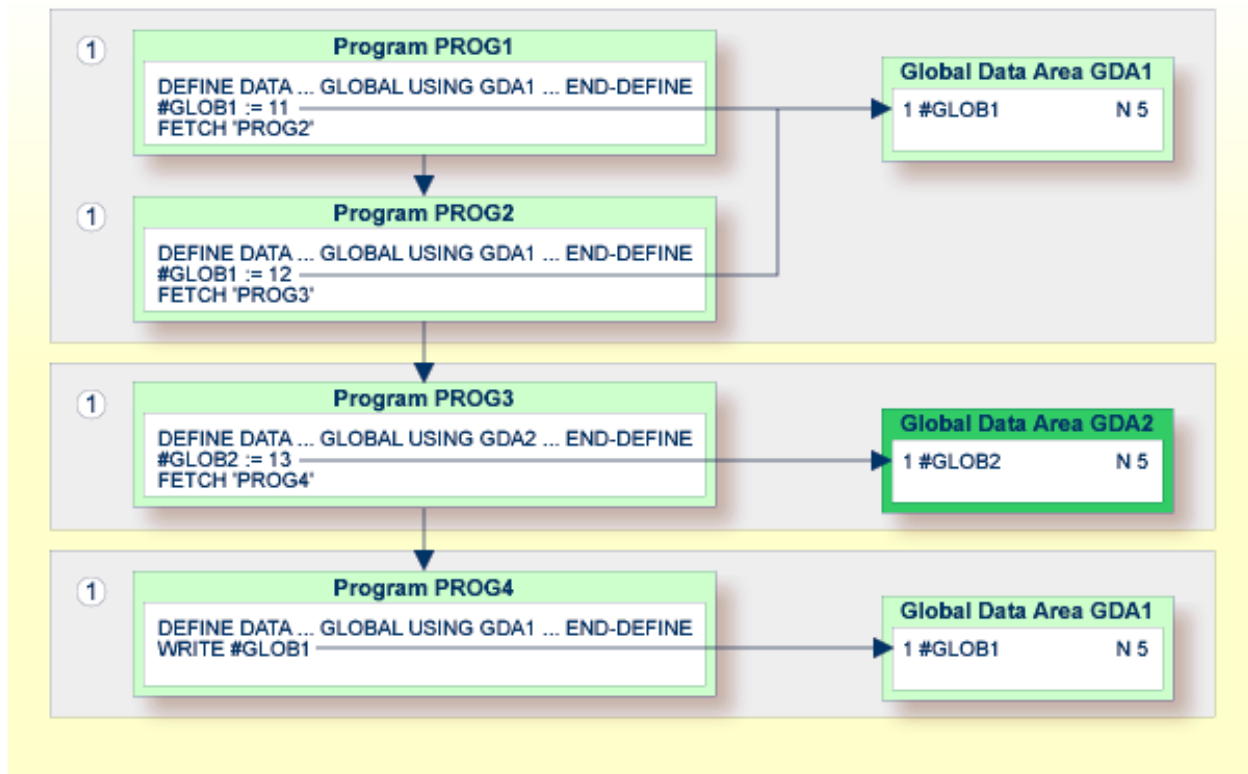

## Data Blocks

To save data storage space, you can create a GDA with data blocks.

The following topics are covered below:

- [Example of Data Block Usage](#)
- [Defining Data Blocks](#)
- [Block Hierarchies](#)

### Example of Data Block Usage

Data blocks can overlay each other during program execution, thereby saving storage space.

For example, given the following hierarchy, Blocks B and C would be assigned the same storage area. Thus it would not be possible for Blocks B and C to be in use at the same time. Modifying Block B would result in destroying the contents of Block C.

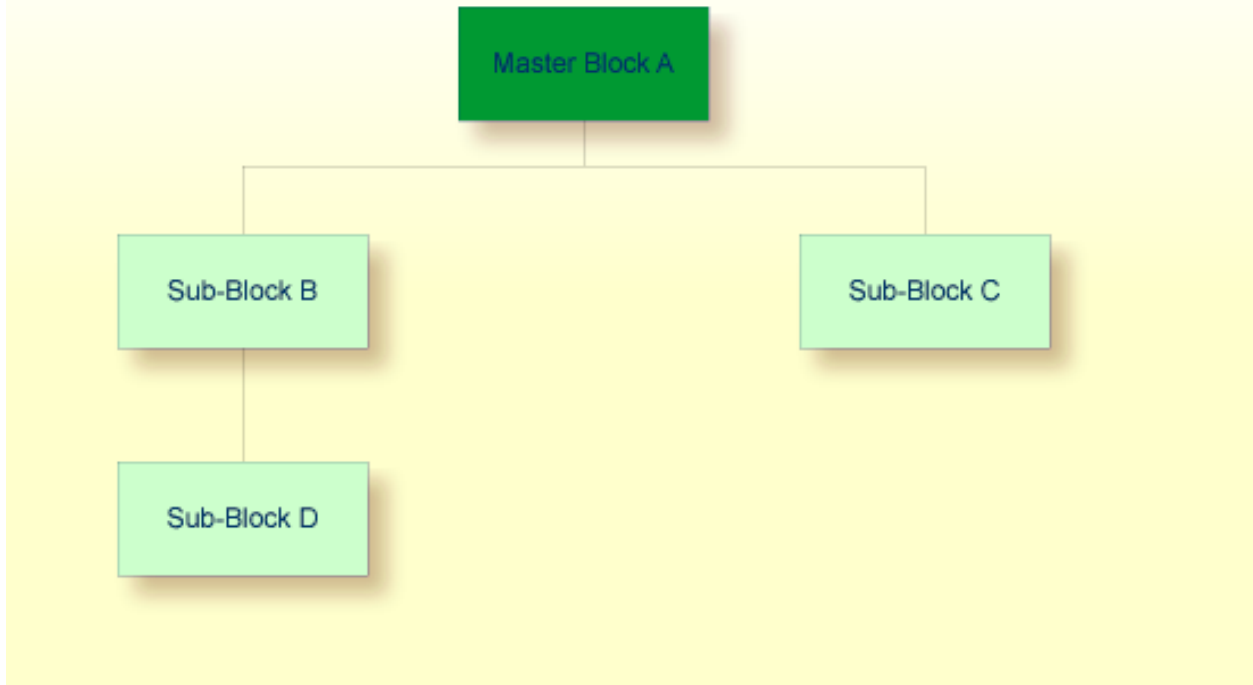

### Defining Data Blocks

You define data blocks in the source editor. You establish the block hierarchy by specifying which block is subordinate to which: you do this by entering the name of the “parent” block in the comment field of the block definition.

In the following example, SUB-BLOCKB and SUB-BLOCKC are subordinate to MASTER-BLOCKA; SUB-BLOCKD is subordinate to SUB-BLOCKB.

The maximum number of block levels is 8 (including the master block).

### Example:

Global Data Area G-BLOCK:

I	T	L	Name	F	Leng	Index/Init/EM/Name/Comment
B			MASTER-BLOCKA			
	1		MB-DATA01	A	10	
B			SUB-BLOCKB			MASTER-BLOCKA
	1		SBB-DATA01	A	20	
B			SUB-BLOCKC			MASTER-BLOCKA
	1		SBC-DATA01	A	40	
B			SUB-BLOCKD			SUB-BLOCKB

```
1 SBD-DATA01                A    40
```

To make the specific blocks available to a program, you use the following syntax in the `DEFINE DATA` statement:

### Program 1:

```
DEFINE DATA GLOBAL
  USING G-BLOCK
  WITH MASTER-BLOCKA
END-DEFINE
```

### Program 2:

```
DEFINE DATA GLOBAL
  USING G-BLOCK
  WITH MASTER-BLOCKA.SUB-BLOCKB
END-DEFINE
```

### Program 3:

```
DEFINE DATA GLOBAL
  USING G-BLOCK
  WITH MASTER-BLOCKA.SUB-BLOCKC
END-DEFINE
```

### Program 4:

```
DEFINE DATA GLOBAL
  USING G-BLOCK
  WITH MASTER-BLOCKA.SUB-BLOCKB.SUB-BLOCKD
END-DEFINE
```

With this structure, Program 1 can share the data in `MASTER-BLOCKA` with Program 2, Program 3 or Program 4. However, Programs 2 and 3 cannot share the data areas of `SUB-BLOCKB` and `SUB-BLOCKC` because these data blocks are defined at the same level of the structure and thus occupy the same storage area.

## Block Hierarchies

Care needs to be taken when using data block hierarchies. Let us assume the following scenario with three programs using a data block hierarchy:

### Program 1:

```
DEFINE DATA GLOBAL
    USING G-BLOCK
    WITH MASTER-BLOCKA.SUB-BLOCKB
END-DEFINE
*
MOVE 1234 TO SBB-DATA01
FETCH 'PROGRAM2'
END
```

### Program 2:

```
DEFINE DATA GLOBAL
    USING G-BLOCK
    WITH MASTER-BLOCKA
END-DEFINE
*
FETCH 'PROGRAM3'
END
```

### Program 3:

```
DEFINE DATA GLOBAL
    USING G-BLOCK
    WITH MASTER-BLOCKA.SUB-BLOCKB
END-DEFINE
*
WRITE SBB-DATA01
END
```

### Explanation:

- Program 1 uses the global data area G-BLOCK with MASTER-BLOCKA and SUB-BLOCKB. The program modifies a field in SUB-BLOCKB and fetches Program 2 which specifies only MASTER-BLOCKA in its data definition.
- Program 2 resets (deletes the contents of) SUB-BLOCKB. The reason is that a program on Level 1 (for example, a program called with a FETCH statement) resets any data blocks that are subordinate to the blocks it defines in its own data definition.
- Program 2 now fetches Program 3 which is to display the field modified in Program 1, but it returns an empty screen.

For details on program levels, see [Multiple Levels of Invoked Objects](#).

## Parameter Data Area

---

A subprogram is invoked with a `CALLNAT` statement. With the `CALLNAT` statement, parameters can be passed from the invoking object to the subprogram.

These parameters must be defined with a `DEFINE DATA PARAMETER` statement in the subprogram:

- they can be defined in the `PARAMETER` clause of the `DEFINE DATA` statement itself; or
- they can be defined in a separate parameter data area, with the `DEFINE DATA PARAMETER` statement referencing that PDA.

The following topics are covered below:

- [Parameters Defined within `DEFINE DATA PARAMETER` Statement](#)



- Parameters Defined in Parameter Data Area

### Parameters Defined within DEFINE DATA PARAMETER Statement

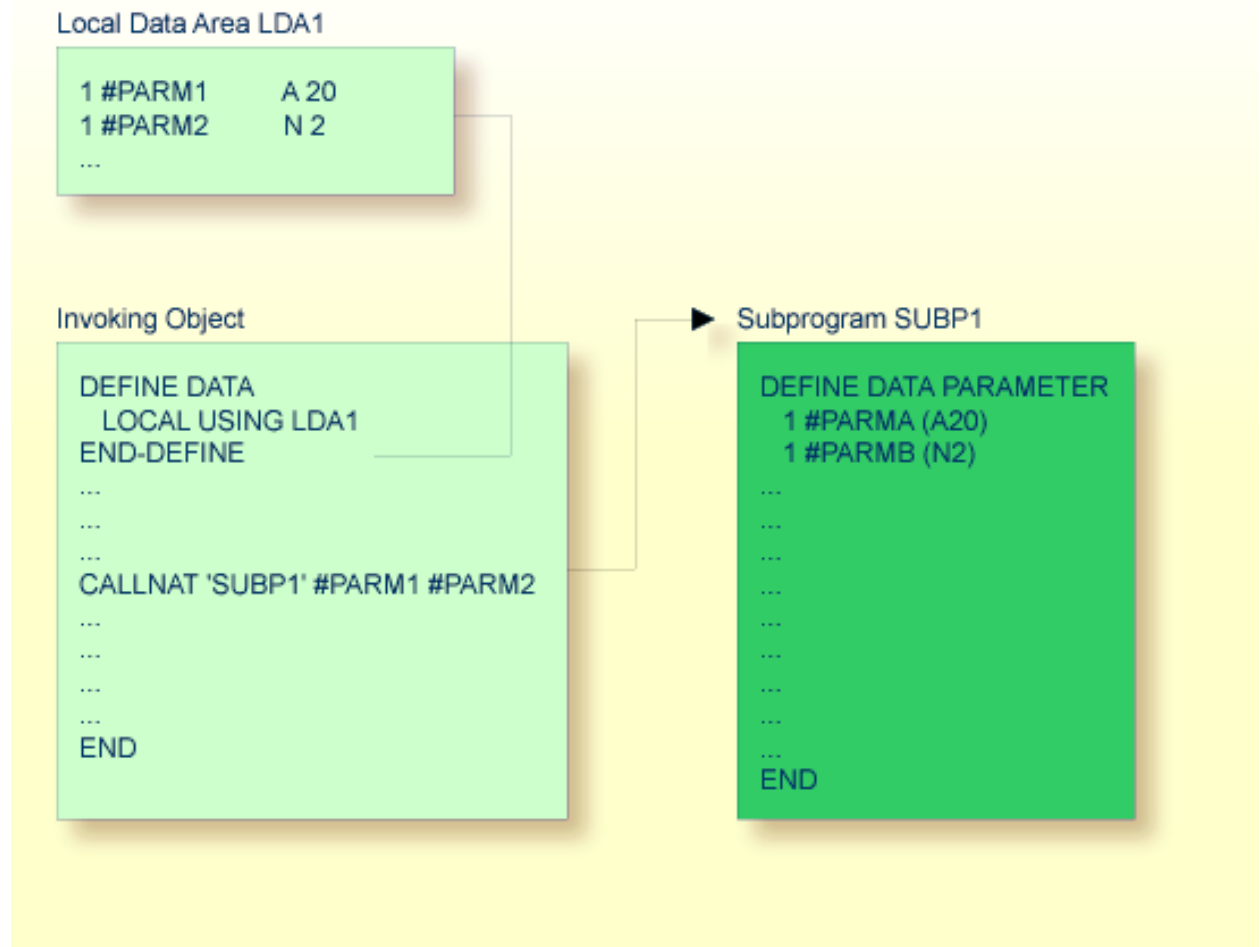

## Parameters Defined in Parameter Data Area

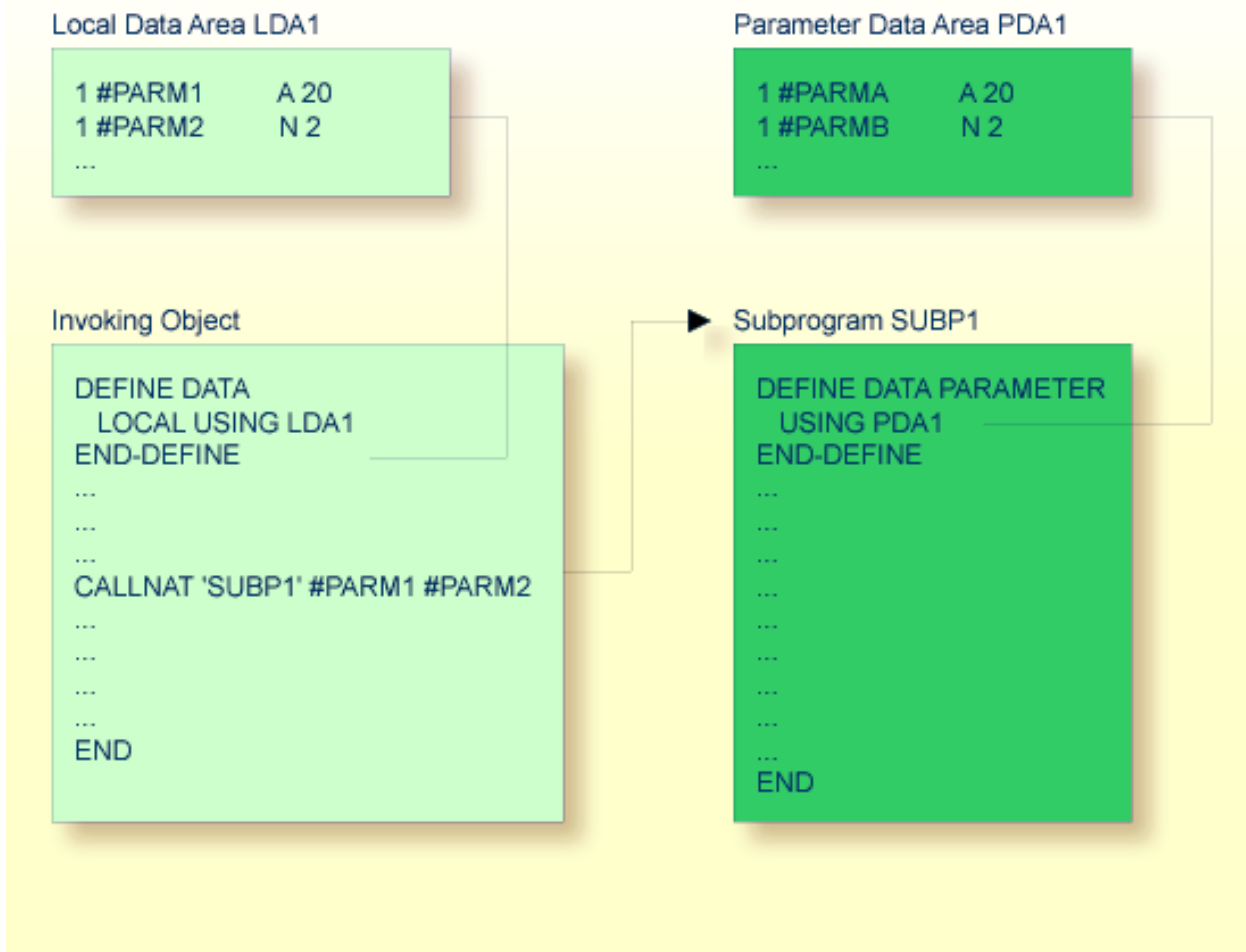

In the same way, parameters that are passed to an external subroutine via a `PERFORM` statement must be defined with a `DEFINE DATA PARAMETER` statement in the external subroutine.

In the invoking object, the parameter variables passed to the subprogram/subroutine need not be defined in a PDA; in the illustrations above, they are defined in the LDA used by the invoking object (but they could also be defined in a GDA).

The sequence, format and length of the parameters specified with the `CALLNAT/PERFORM` statement in the invoking object must exactly match the sequence, **format** and length of the fields specified in the `DEFINE DATA PARAMETER` statement of the invoked subprogram/subroutine. However, the names of the variables in the invoking object and the invoked subprogram/subroutine need not be the same (as the parameter data are transferred by address, not by name).

To guarantee that the data element definitions used in the invoking program are identical to the data element definitions used in the subprogram or external subroutine, you can specify a PDA

in a `DEFINE DATA LOCAL USING` statement. By using a PDA as an LDA you can avoid the extra effort of creating an LDA that has the same structure as the PDA.



# 4 Programs, Functions, Subprograms and Subroutines

---

- A Modular Application Structure ..... 32
- Multiple Levels of Invoked Objects ..... 32
- Program ..... 34
- Function ..... 37
- Subroutine ..... 39
- Subprogram ..... 44
- Processing Flow when Invoking a Routine ..... 46

This document discusses those object types which can be invoked as routines; that is, as subordinate programs.

Help routines and maps, although they are also invoked from other objects, are strictly speaking not routines as such, and are therefore discussed in separate documents; see [Help routines](#) and [Maps](#).

## A Modular Application Structure

---

Typically, a Natural application does not consist of a single huge program, but is split into several modules. Each of these modules will be a functional unit of manageable size, and each module is connected to the other modules of the application in a clearly defined way. This provides for a well structured application, which makes its development and subsequent maintenance a lot easier and faster.

During the execution of a main program, other programs, subprograms, subroutines, help routines and maps can be invoked. These objects can in turn invoke other objects (for example, a subroutine can itself invoke another subroutine). Thus, the modular structure of an application can become quite complex and extend over several levels.

## Multiple Levels of Invoked Objects

---

Each invoked object is one level below the level of the object from which it was invoked; that is, with each invocation of a subordinate object, the level number is incremented by 1.

Any program that is directly executed is at Level 1; any subprogram, subroutine, map or help routine directly invoked by the main program is at Level 2; when such a subroutine in turn invokes another subroutine, the latter is at Level 3.

A program invoked with a `FETCH` statement from within another object is classified as a main program, operating from Level 1. A program that is invoked with `FETCH RETURN`, however, is classified as a subordinate program and is assigned a level one below that of the invoking object.

The following illustration is an example of multiple levels of invoked objects and also shows how these levels are counted:

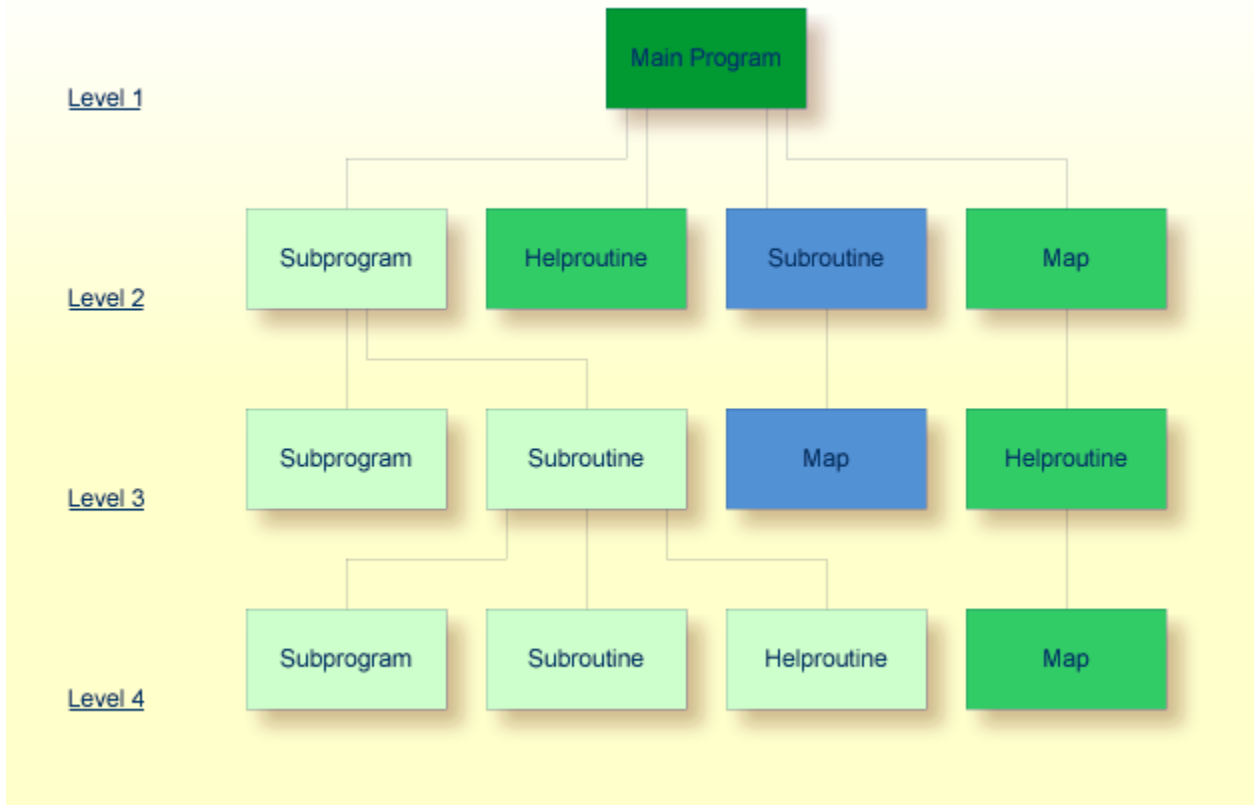

If you wish to ascertain the level number of the object that is currently being executed, you can use the system variable `*LEVEL` (which is described in the *System Variables* documentation).

This document discusses the following Natural object types, which can be invoked as routines (that is, subordinate programs):

- program
- function
- subroutine
- subprogram

Helproutines and maps, although they are also invoked from other objects, are strictly speaking not routines as such, and are therefore discussed in separate documents; see [Helproutines](#) and [Maps](#).

Basically, programs, subprograms and subroutines differ from one another in the way data can be passed between them and in their possibilities of sharing each other's data areas. Therefore the decision which object type to use for which purpose depends very much on the data structure of your application.

## Program

---

A program can be executed - and thus tested - by itself.

A program can also be invoked from another object with a `FETCH` or `FETCH RETURN` statement. The invoking object can be another program, a **subprogram**, **function**, **subroutine** or **helproutine**.

- When a program is invoked with `FETCH RETURN`, the execution of the invoking object will be suspended - not terminated - and the fetched program will be activated as a *subordinate program*. When the execution of the `FETCHed` program is terminated, the invoking object will be re-activated and its execution continued with the statement following the `FETCH RETURN` statement.
- When a program is invoked with `FETCH`, the execution of the invoking object will be terminated and the `FETCHed` program will be activated as a *main program*. The invoking object will not be re-activated upon termination of the fetched program.

The following topics are covered below:

- [Program Invoked with `FETCH RETURN`](#)



- Program Invoked with FETCH

### Program Invoked with FETCH RETURN

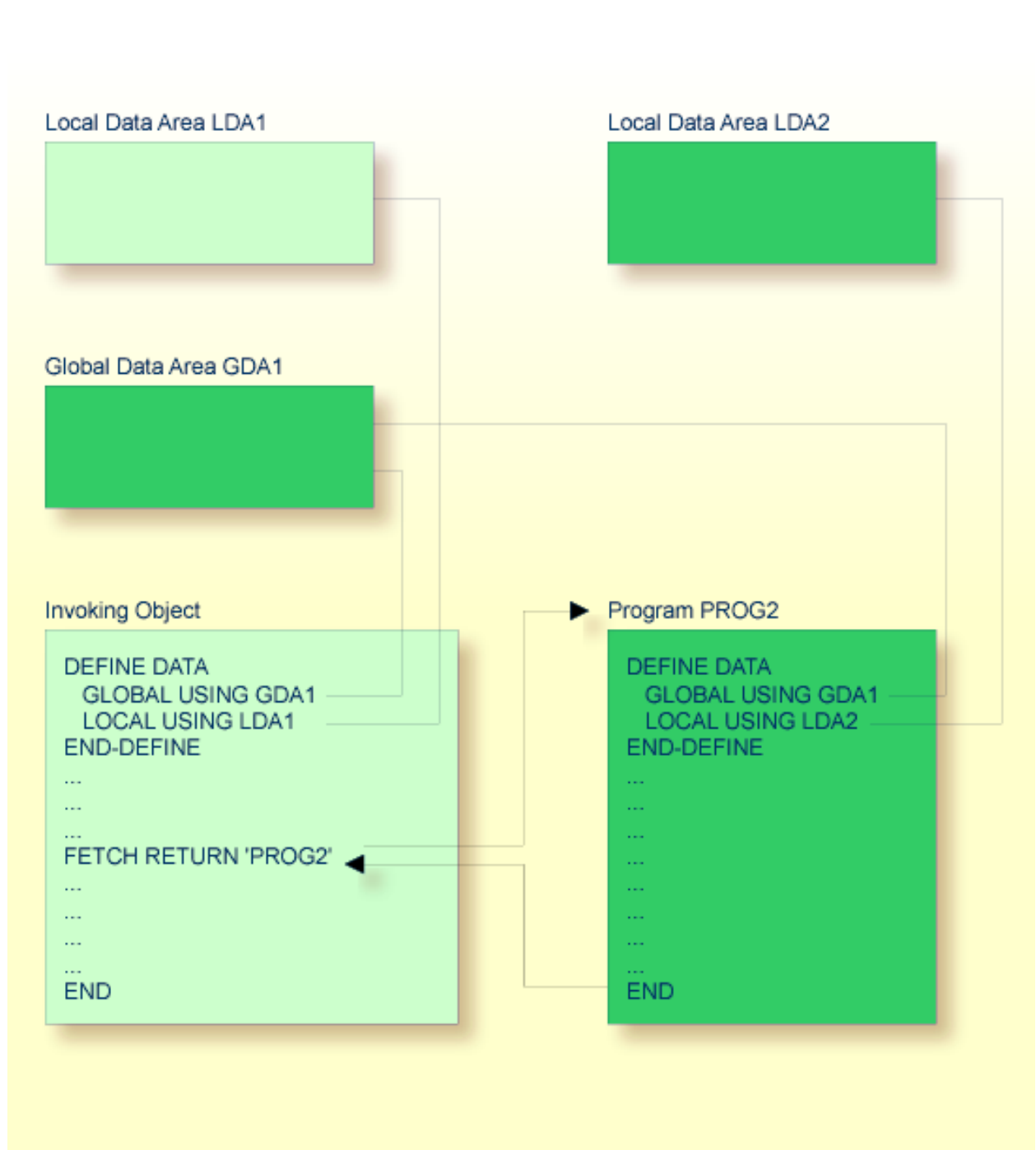

A program invoked with `FETCH RETURN` can access the global data area used by the invoking object.

In addition, every program can have its own local data area, in which the fields that are to be used only within the program are defined.

However, a program invoked with `FETCH RETURN` cannot have its own global data area.

### Program Invoked with `FETCH`

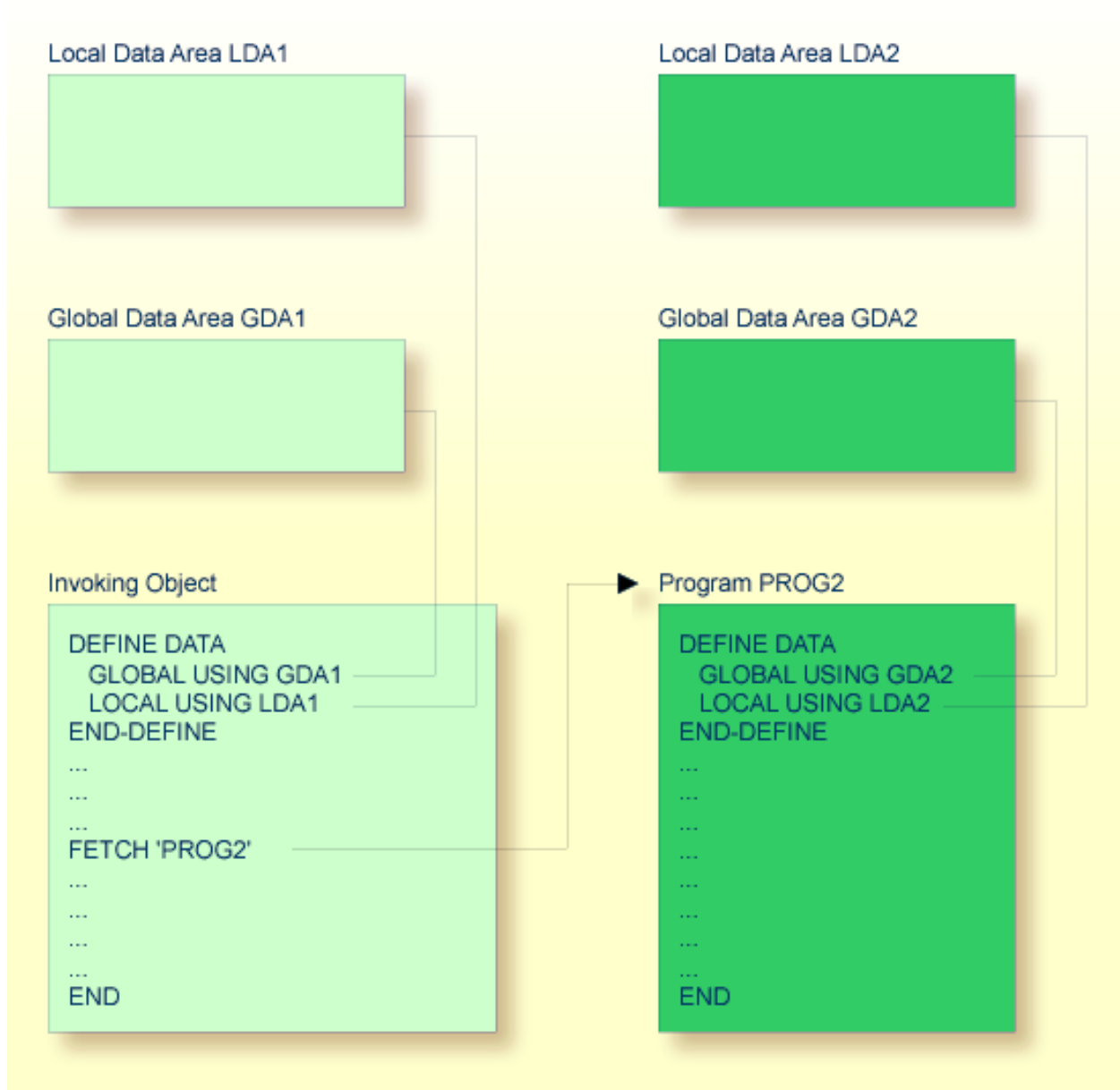

A program invoked with `FETCH` as a main program usually establishes its own global data area (as shown in the illustration above). However, it could also use the same global data area as established by the invoking object.



**Note:** A source program can also be invoked with a `RUN` statement; see the `RUN` statement in the *Statements* documentation.

## Function

The Natural object of type function contains one `DEFINE FUNCTION` statement for the definition of a single function and the `END` statement. The function itself can be invoked using the **function call** syntax.

The basic structure of the `DEFINE FUNCTION` statement is like this:

```
DEFINE FUNCTION function-name
  RETURNS ...
  DEFINE DATA
  ...
  END-DEFINE

  statements ...

END-FUNCTION
```

And the function call has the structure:

```
function-name (< ... >)
```

The `DEFINE FUNCTION` statement offers the keyword `RETURNS` for the result value of a function. With the `DEFINE DATA` statement, the parameters for the function call as well as local and independent variables for the function logic can be defined. A global data area (for example, `GDA1`) cannot be referenced inside the function definition.

The block of statements after the `RETURNS` keyword and the `DEFINE DATA` statement must contain all those statements which are to be executed when the function is called.

Parameter data areas (for example, `PDA1`) may be used to access parameters for function calls and function definitions in order to minimize the maintenance effort when changing parameters.

The function call can be used either as an operand within a Natural statement or stand-alone in place of a Natural statement. The arguments of the function call must be specified using a special bracket notation: `(<...>)`.

The `DEFINE PROTOTYPE` statement may be used to define the result and parameter layouts for a certain function. This may be considered if the function is not yet available or if a variable function call is to be used. At compilation time, the type of the result variable and the parameters will be checked.

The `DEFINE PROTOTYPE` statement may be included in a **copycode** object if the function call, and therefore the prototype definition can be used in several programming objects.

For further information, see the section *User-Defined Functions*.

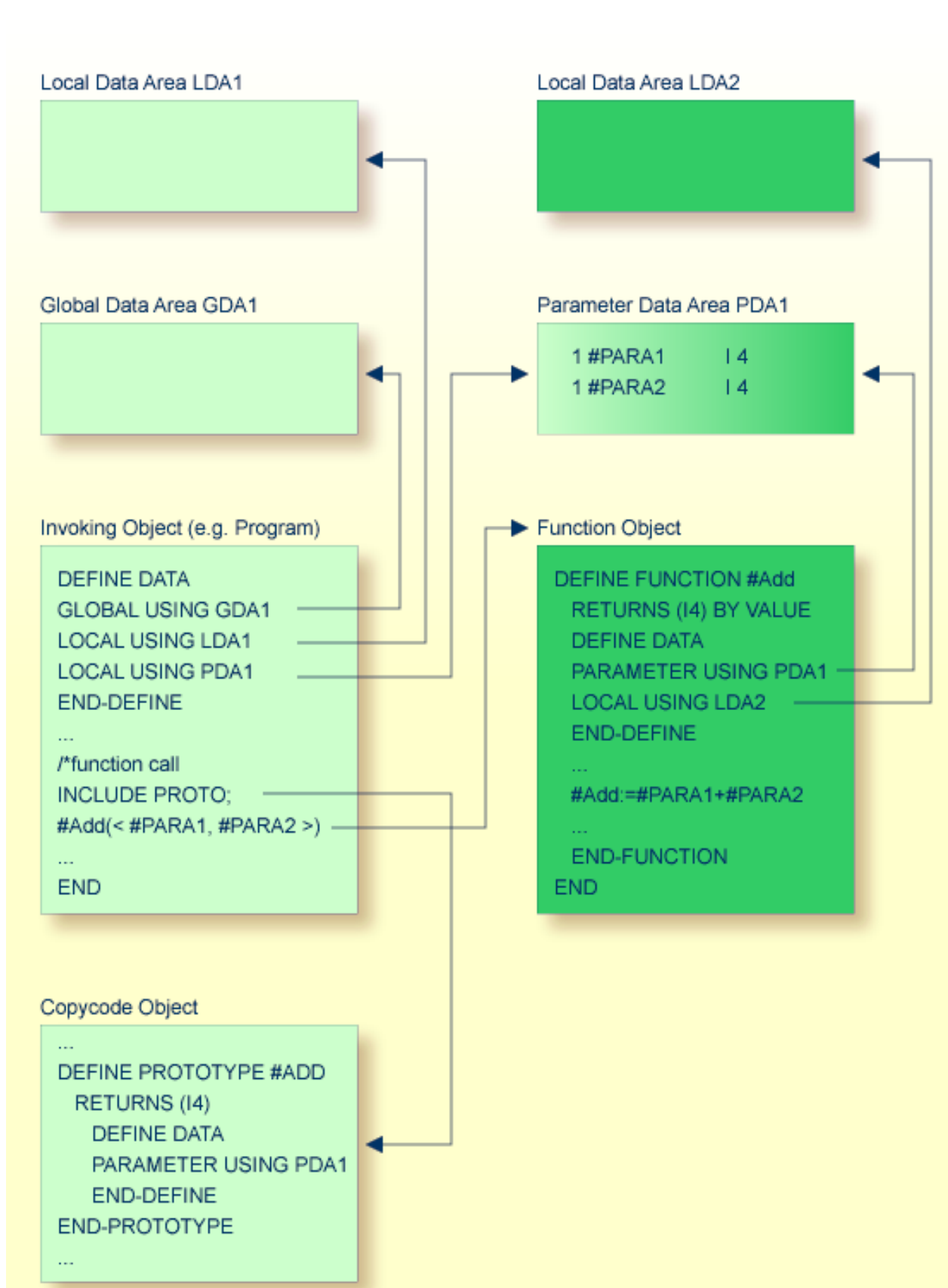

## Subroutine

---

The statements that make up a subroutine must be defined within a `DEFINE SUBROUTINE ... END-SUBROUTINE` statement block.

A subroutine is invoked with a `PERFORM` statement.

A subroutine may be an *inline subroutine* or an *external subroutine*:

- **Inline Subroutine**

An inline subroutine is defined within the object which contains the `PERFORM` statement that invokes it.

- **External Subroutine**

An external subroutine is defined in a separate object - of type subroutine - outside the object which invokes it.

If you have a block of code which is to be executed several times within an object, it is useful to use an inline subroutine. You then only have to code this block once within a `DEFINE SUBROUTINE` statement block and invoke it with several `PERFORM` statements.

The following topics are covered below:

- [Inline Subroutine](#)
- [Data Available to an Inline Subroutine](#)
- [External Subroutine](#)

- [Data Available to an External Subroutine](#)

## **Inline Subroutine**

Local Data Area LDA1

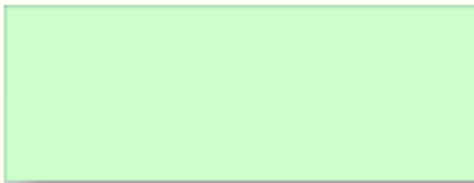

Global Data Area GDA1

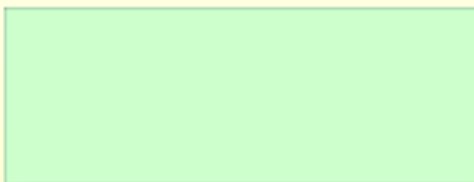

Invoking Object

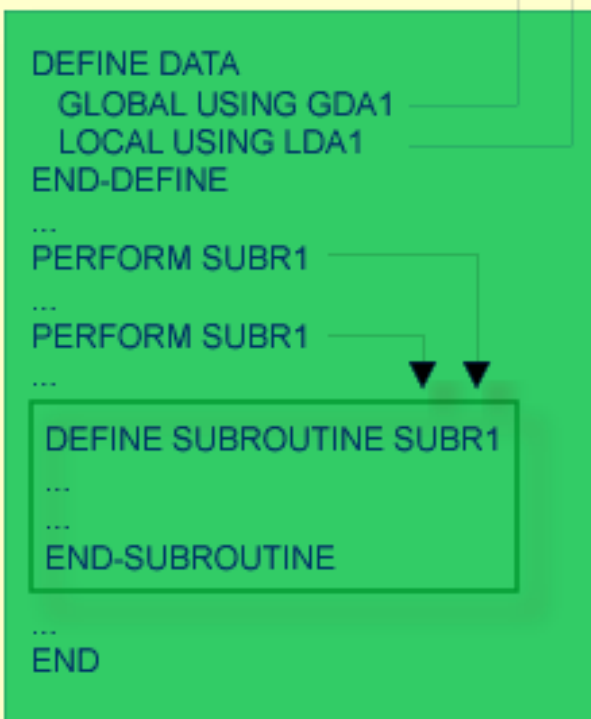

An inline subroutine can be contained within a programming object of type program, **function**, subprogram, subroutine or helproutine.

If an inline subroutine is so large that it impairs the readability of the object in which it is contained, you may consider putting it into an external subroutine, so as to enhance the readability of your application.

### **Data Available to an Inline Subroutine**

An inline subroutine has access to the local data area and the global data area used by the object in which it is contained.



## External Subroutine

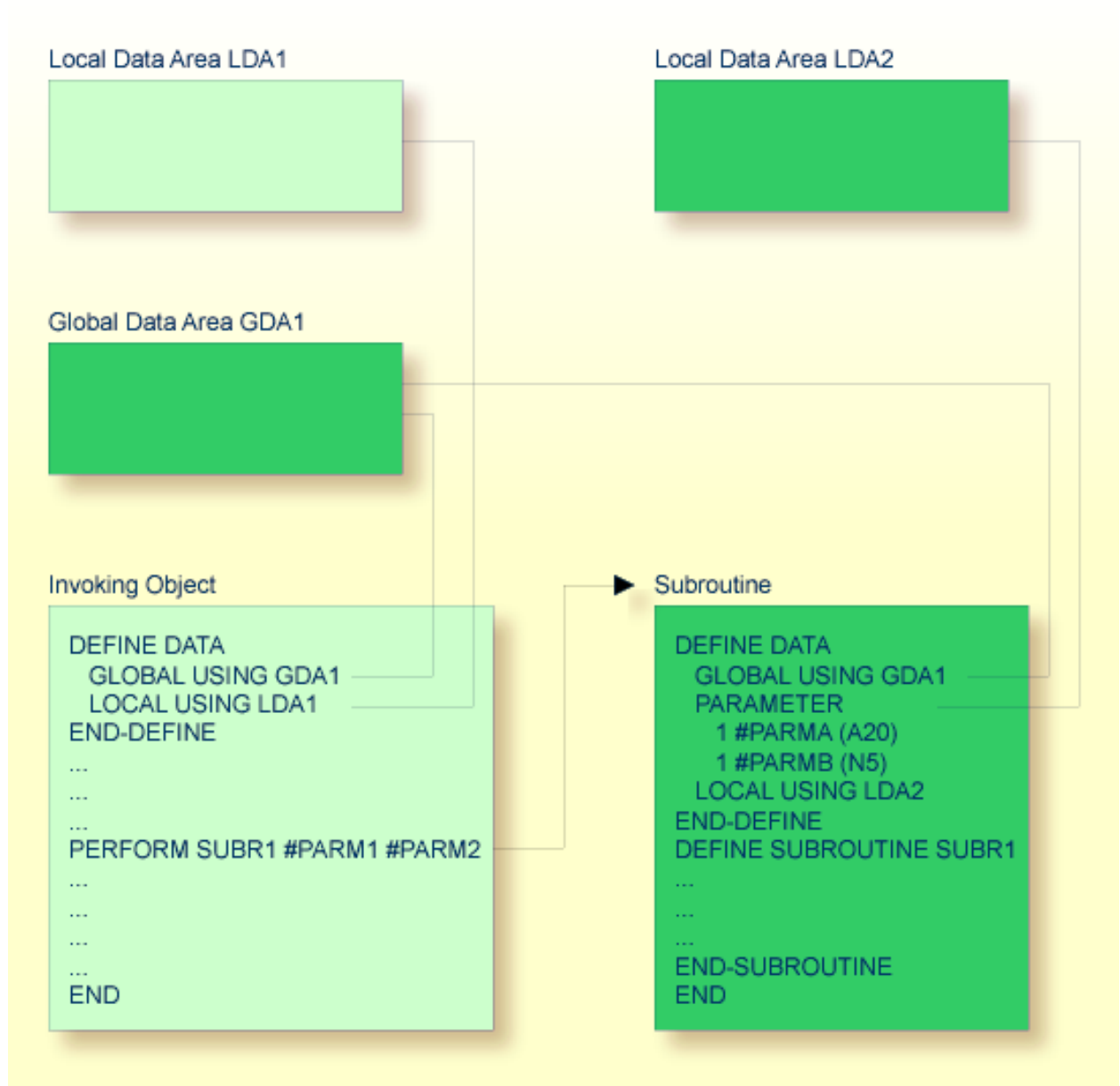

An external subroutine - that is, an object of type subroutine - cannot be executed by itself. It must be invoked from another object. The invoking object can be a program, **function**, subprogram, subroutine or helproutine.

## Data Available to an External Subroutine

An external subroutine can access the global data area used by the invoking object.

Moreover, parameters can be passed with the `PERFORM` statement from the invoking object to the external subroutine. These parameters must be defined either in the `DEFINE DATA PARAMETER` statement of the subroutine, or in a **parameter data area** used by the subroutine.

In addition, an external subroutine can have its **local data area**, in which the fields that are to be used only within the subroutine are defined.

However, an external subroutine cannot have its own **global data area**.

## Subprogram

---

Typically, a subprogram would contain a generally available standard function that is used by various objects in an application.

A subprogram cannot be executed by itself. It must be invoked from another object. The invoking object can be a program, **function**, subprogram, subroutine or help routine.

A subprogram is invoked with a `CALLNAT` statement.

When the `CALLNAT` statement is executed, the execution of the invoking object will be suspended and the subprogram executed. After the subprogram has been executed, the execution of the invoking object will be continued with the statement following the `CALLNAT` statement.

## Data Available to a Subprogram

With the `CALLNAT` statement, parameters can be passed from the invoking object to the subprogram. These parameters are the only data available to the subprogram from the invoking object. They must be defined either in the `DEFINE DATA PARAMETER` statement of the subprogram, or in a **parameter data area** used by the subprogram.

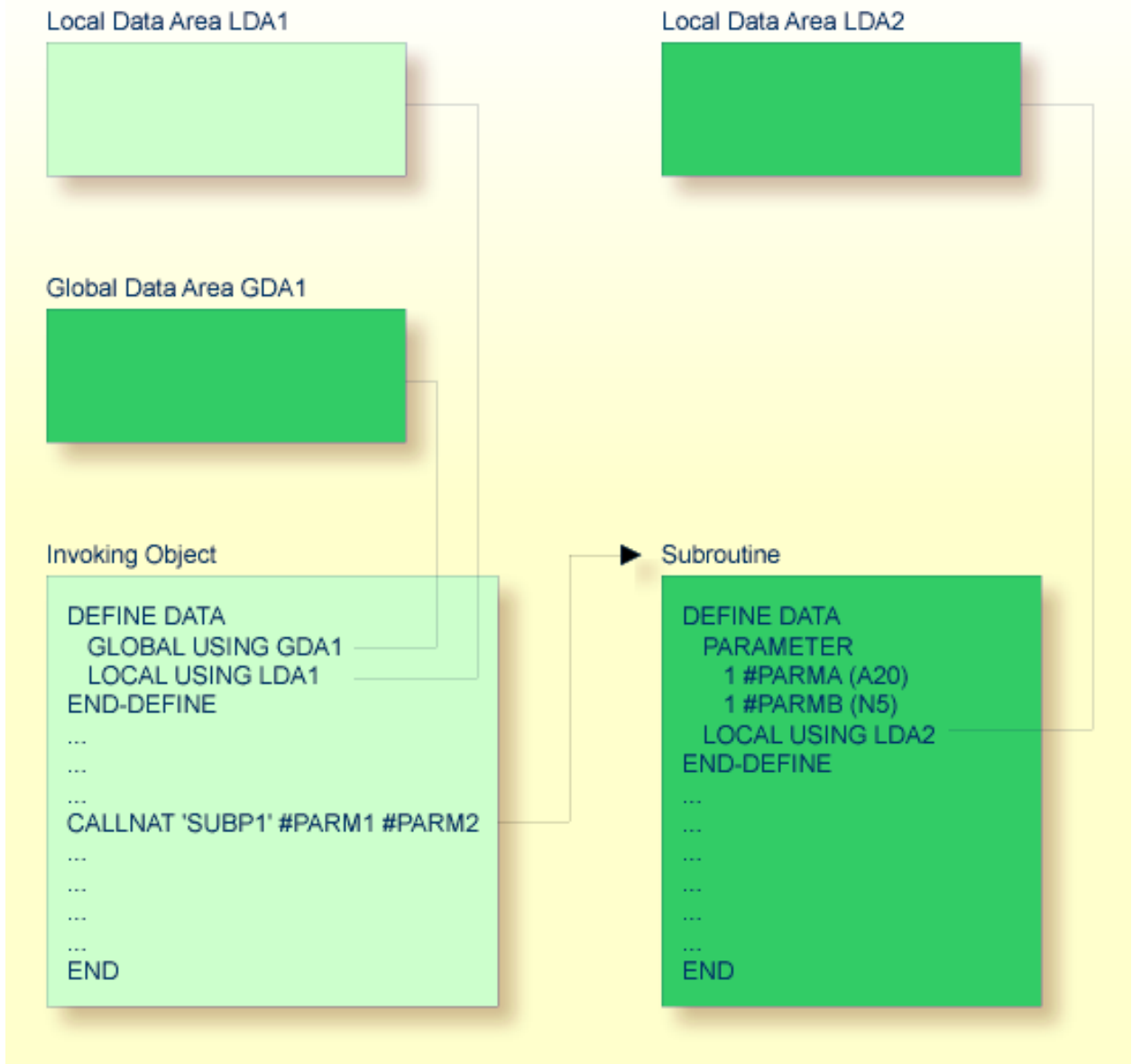

In addition, a subprogram can have its own local data area, in which the fields to be used within the subprogram are defined.

If a subprogram in turn invokes a subroutine or helproutine, it can also establish its own global data area to be shared with the subroutine/helproutine.

## Processing Flow when Invoking a Routine

---

When the `CALLNAT`, `PERFORM` or `FETCH RETURN` statement that invokes a routine - a subprogram, an external subroutine, or a program respectively - is executed, the execution of the invoking object is suspended and the execution of the routine begins.

The execution of the routine continues until either its `END` statement is reached or processing of the routine is stopped by an `ESCAPE ROUTINE` statement being executed.

In either case, processing of the invoking object will then continue with the statement following the `CALLNAT`, `PERFORM` or `FETCH RETURN` statement used to invoke the routine.

**Example:**

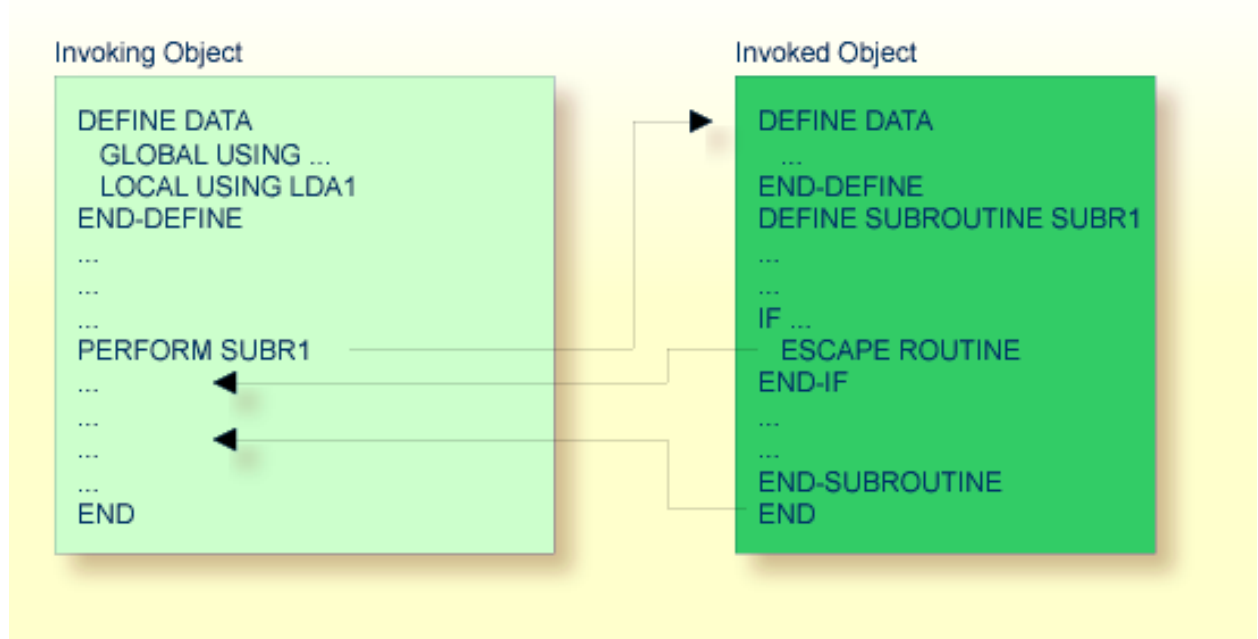



## 5 Processing a Rich GUI Page - Adapter

---

The Natural object of type “adapter” is used to represent a rich GUI page in a Natural application. This object type plays a similar role for the processing of a rich GUI page as the object type map plays for terminal I/O processing. But it is different from a map in that it does not contain layout information.

An object of type adapter is generated from an external page layout. It serves as an interface that enables a Natural application to send data to an external I/O system for presentation and modification, using an externally defined and stored page layout. The adapter contains the Natural code necessary to perform this task.

An application program refers to an adapter in the `PROCESS PAGE USING` statement.

For information on the object type “adapter”, see the *Natural for Ajax* documentation.





# 6 Maps

---

- Benefits of Using Maps ..... 52
- Types of Maps ..... 52
- Creating Maps ..... 53
- Starting/Stopping Map Processing ..... 53

As an alternative to specifying screen layouts dynamically, the `INPUT` statement offers the possibility to use predefined map layouts which makes use of the Natural object type “map”.

## Benefits of Using Maps

---

Using predefined map layouts rather than dynamic screen-layout specifications offers various advantages such as:

- Clearly structured applications as a result of a consequent separation of program logic and display logic.
- Map layout modifications possible without making changes to the main programs.
- The language of an applications's user interface can be easily adapted for internationalization or localization.

The benefit of using programming objects such as maps will become obvious when it comes to maintaining existing Natural applications.

## Types of Maps

---

Maps (screen layouts) are those parts of an application which the users see on their screens.

The following types of maps exist:

- **Input Map**  
The dialog with the user is carried out via input maps.
- **Output Map**  
If an application produces any output report, this report can be displayed on the screen by using an output map.
- **Help Map**  
Help maps are, in principle, like any other maps, but when they are assigned as help, additional checks are performed to ensure their usability for help purpose.

The object type “map” comprises

- the map body which defines the screen layout and
- an associated **parameter data area** (PDA) which, as a sort of interface, contains data definitions such as name, **format**, length of each field presented on a specific map.

Related Topics:

- For information on selection boxes that can be attached to input fields, see *SB - Selection Box* in the `INPUT` statement documentation and *SB - Selection Box* in the *Parameter Reference*.
- For information on split screen maps where the upper portion may be used as an output map and the lower portion as an input map, see *Split-Screen Feature* in the `INPUT` statement documentation.

## Creating Maps

---

Maps and help map layouts are created and edited in the map editor.

The map editor is used to create character-based user interfaces. If you want to create complex graphical user interfaces, you will use *Ajax Developer* instead. *Ajax Developer* includes a number of tools. Its central tool is the *Layout Painter* which is used to define layouts for HTML pages. The appropriate local data area (LDA) is created and maintained in the source editor.

- For information on input processing using screen layouts specified dynamically, see *Syntax 1 - Dynamic Screen Layout Specification* in the `INPUT` statement documentation.
- For information on input processing using a map layout created with the map editor, see *Syntax 2 - Using Predefined Map Layout* in the `INPUT` statement documentation.

## Starting/Stopping Map Processing

---

An *input map* is invoked with an `INPUT USING MAP` statement.

An *output map* is invoked with a `WRITE USING MAP` statement.

Processing of a map can be stopped with an `ESCAPE ROUTINE` statement in a processing rule.



# 7 Helproutines

---

▪ Invoking Help .....	56
▪ Specifying Helproutines .....	56
▪ Programming Considerations for Helproutines .....	57
▪ Passing Parameters to Helproutines .....	57
▪ Equal Sign Option .....	58
▪ Array Indices .....	59
▪ Help as a Window .....	59

Helproutines have specific characteristics to facilitate the processing of help requests. They may be used to implement complex and interactive help systems. They are created with the source editor.

## Invoking Help

---

A Natural user can invoke a Natural helproutine either by entering the help character in a field, or by pressing the help key (usually PF1). The default help character is a question mark (?).

- The help character must be entered only once.
- The help character must be the only character modified in the input string.
- The help character must be the first character in the input string.

If a helproutine is specified for a numeric field, Natural will allow a question mark to be entered for the purpose of invoking the helproutine for that field. Natural will still check that valid numeric data are provided as field input.

If not already specified, the help key may be specified with the `SET KEY` statement:

```
SET KEY PF1=HELP
```

A helproutine can only be invoked by a user if it has been specified in the **program** or **map** from which it is to be invoked.

## Specifying Helproutines

---

A helproutine may be specified:

- in a program: at statement level and at field level;
- in a map: at map level and at field level.

If a user requests help for a field for which no help has been specified, or if a user requests help without a field being referenced, the helproutine specified at the statement or map level is invoked.

A helproutine may also be invoked by using a `REINPUT USING HELP` statement (either in the program itself or in a processing rule). If the `REINPUT USING HELP` statement contains a `MARK` option, the helproutine assigned to the marked field is invoked. If no field-specific helproutine is assigned, the map helproutine is invoked.

A `REINPUT` statement in a helproutine may only apply to `INPUT` statements within the same helproutine.

The name of a help routine may be specified either with the session parameter `HE` of an `INPUT` statement:

```
INPUT (HE='HELP2112')
```

or by using the map editor.

The name of a help routine may be specified as an alphanumeric constant or as an alphanumeric variable containing the name. If it is a constant, the name of the help routine must be specified within apostrophes.

## Programming Considerations for Help routines

Processing of a help routine can be stopped with an `ESCAPE ROUTINE` statement.

Be careful when using `END OF TRANSACTION` or `BACKOUT TRANSACTION` statements in a help routine, because this will affect the transaction logic of the main program.

## Passing Parameters to Help routines

A help routine can access the currently active **global data area** (but it cannot have its own global data area). In addition, it can have its own **local data area**.

Data may also be passed from/to a help routine via parameters. A help routine may have up to 20 explicit parameters and one implicit parameter. The explicit parameters are specified with the `HE` operand after the help routine name:

```
HE='MYHELP', '001'
```

The implicit parameter is the field for which the help routine was invoked:

```
INPUT #A (A5) (HE='YOURHELP', '001')
```

where `001` is an explicit parameter and `#A` is the implicit parameter/the field.

This is specified within the `DEFINE DATA PARAMETER` statement of the help routine as:

```
DEFINE DATA PARAMETER
1 #PARM1 (A3)           /* explicit parameter
1 #PARM2 (A5)           /* implicit parameter
END-DEFINE
```

Please note that the implicit parameter (`#PARM2` in the above example) may be omitted. The implicit parameter is used to access the field for which help was requested, and to return data from the helproutine to the field. For example, you might implement a calculator program as a helproutine and have the result of the calculations returned to the field.

When help is called, the helproutine is called before the data are passed from the screen to the program data areas. This means that helproutines cannot access data entered within the same screen transaction.

Once help processing is complete, the screen data will be refreshed: any fields which have been modified by the helproutine will be updated - excluding fields which had been modified by the user before the helproutine was invoked, but including the field for which help was requested. Exception: If the field for which help was requested is split into several parts by dynamic attributes (`DY` session parameter), and the part in which the question mark is entered is *after* a part modified by the user, the field content will not be modified by the helproutine.

Attribute control variables are not evaluated again after the processing of the helproutine, even if they have been modified within the helproutine.

## Equal Sign Option

---

The equal sign (=) may be specified as an explicit parameter:

```
INPUT PERSONNEL-NUMBER (HE='HELPROUT',=)
```

This parameter is processed as an internal field (**format**/length A65) which contains the field name (or map name if specified at map level). The corresponding helproutine starts with:

```
DEFINE DATA PARAMETER
1 FNAME (A65)           /* contains 'PERSONNEL-NUMBER'
1 FVALUE (N8)           /* value of field (optional)
END-DEFINE
```

This option may be used to access one common helproutine which reads the field name and provides field-specific help by accessing the application online documentation or the Predict data dictionary.



## Array Indices

If the field selected by the help character or the help key is an **array** element, its indices are supplied as implicit parameters (1 - 3 depending on rank, regardless of the explicit parameters).

The **format**/length of these parameters is I2.

```
INPUT A(*,*) (HE='HELPROUT',=)
```

The corresponding help routine starts with:

```
DEFINE DATA PARAMETER
1 FNAME (A65) /* contains 'A'
1 FVALUE (N8) /* value of selected element
1 FINDEX1 (I2) /* 1st dimension index
1 FINDEX2 (I2) /* 2nd dimension index
END-DEFINE
...
```

## Help as a Window

The size of a help to be displayed may be smaller than the screen size. In this case, the help appears on the screen as a window, enclosed by a frame, for example:

```
*****
                                PERSONNEL INFORMATION
PLEASE ENTER NAME: ? _____
PLEASE ENTER CITY:  _____
                                +-----+
                                !           !
                                ! Type in the name of an      !
                                ! employee in the first        !
                                ! field and press ENTER.       !
                                ! You will then receive        !
                                ! a list of all employees      !
                                ! of that name.                !
                                !                               !
                                ! For a list of employees      !
                                ! of a certain name who        !
                                ! live in a certain city,      !
                                ! type in a name in the        !
                                ! first field and a city        !
                                ! in the second field          !
                                ! and press ENTER.             !
```

```
*****! |*****  
+-----+
```

Within a helproutine, the size of the window may be specified as follows:

- by a `FORMAT` statement (for example, to specify the page size and line size: `FORMAT PS=15 LS=30`);
- by an `INPUT USING MAP` statement; in this case, the size defined for the map (in its map settings) is used;
- by a `DEFINE WINDOW` statement; this statement allows you to either explicitly define a window size or leave it to Natural to automatically determine the size of the window depending on its contents.

The position of a help window is computed automatically from the position of the field for which help was requested. Natural places the window as close as possible to the corresponding field without overlaying the field. With the `DEFINE WINDOW` statement, you may bypass the automatic positioning and determine the window position yourself.

For further information on window processing, please refer to the `DEFINE WINDOW` statement in the *Statements* documentation and the terminal command `%W` in the *Terminal Commands* documentation.

# 8

## Multiple Use of Source Code - Copycode

---

- Use of Copycode ..... 62
- Processing of Copycode ..... 62

This chapter describes the advantages and the use of copycode.

## Use of Copycode

---

Copycode is a portion of source code which can be included in another object via an `INCLUDE` statement.

So, if you have a statement block which is to appear in identical form in several objects, you may use copycode instead of coding the statement block several times. This reduces the coding effort and also ensures that the blocks are really identical.

## Processing of Copycode

---

The copycode is included at compilation; that is, the source-code lines from the copycode are not physically inserted into the object that contains the `INCLUDE` statement, but they will be included in the compilation process and are thus part of the resulting object module.

Consequently, when you modify the source code of copycode, you also have to catalog all objects which use that copycode.

Attention:

- Copycode cannot be executed on its own. It cannot be stowed, but only saved.
- An `END` statement must not be placed within a copycode.

For further information, refer to the description of the `INCLUDE` statement (in the *Statements* documentation).

# 9 Documenting Natural Objects - Text

---

- Use of Text Objects ..... 64
- Writing Text ..... 64

The Natural object type “text” is used to write text rather than programs.

## Use of Text Objects

---

You can use this type of object to document Natural objects in more detail than you can, for example, within the source code of a program.

Text objects may also be useful at sites where Predict is not available for program documentation purposes.

## Writing Text

---

You write the text using the source editor.

The only difference in handling as opposed to writing programs is that there is no lower to upper case translation, that is, the text you write stays as it is.

You can write any text you wish (there is no syntax check).

Text objects can only be saved, they cannot be stowed. They cannot be executed, but only displayed in the editor.

# 10

## Creating Component Based Applications - Class

---

Classes are used to apply an object based programming style.





# 11 Using Non-Natural Files - Resource

---

■ Use of Resources .....	68
■ Shared Resources .....	68
■ Private Resources .....	69
■ API for Processing Resources .....	69

This section describes the Natural object of type resource.

Non-Natural file types, such as HTML files, XML style sheets, etc., supported by Natural for OpenVMS are located in the different libraries in the *RES* directory. Natural delivers some with the product, but you can also save your own resources for your applications in *RES*.

## Use of Resources

---

Natural distinguishes two kinds of resources:

### ■ Shared Resources

A **shared resource** is any non-Natural file that is used in a Natural application and is maintained in the Natural library system.

### ■ Private Resources

A **private resource** is a file that is assigned to one and only one Natural object and is considered to be part of that object. An object can have at most one private resource file. At the moment, only Natural dialogs have private resources.

Both shared and private resources belonging to a Natural library are maintained in a subdirectory named *..\RES* in the directory that represents the Natural library in the file system.

## Shared Resources

---

A shared resource is any non-Natural file that is used in a Natural application and is maintained in the Natural library system. A non-Natural file that is to be used as a shared resource must be contained in the subdirectory named *..\RES* of a Natural library.

### Example of Using a Shared Resource

The bitmap *MYPICTURE.BMP* is to be displayed in a bitmap control in a dialog *MYDLG*, contained in a library *MYLIB*. First the bitmap is put into the Natural library *MYLIB* by moving it into the directory *..\MYLIB\RES*. The following code snippet from the dialog *MYDLG* shows how it is then assigned to the bitmap control:

```
DEFINE DATA LOCAL
01 #BM-1 HANDLE OF BITMAP
...
END-DEFINE
* (Creation of the Bitmap control omitted.)
...
#BM-1.BITMAP-FILE-NAME := "MYPICTURE.BMP" ... ↵
```

The advantages of using the bitmap as a shared resource are:

- The file name can be specified in the Natural dialog without a path name.
- The file can be kept in a Natural library together with the Natural object that uses it.



**Note:** In previous Natural versions non-Natural files were usually kept in a directory that was defined with the environment variable `NATGUI_BMP`. Existing applications that use this approach will work in the same way as before, because Natural always searches for a shared resource file in this directory, if it was not found in the current library.

## Private Resources

---

Private resources are used internally by Natural to store binary data that is part of Natural objects. These files are recognized by the file name extension `NR*`, where `*` is a character that depends on the type of the Natural object. Natural maintains private resource files and their contents automatically. A Natural object can have a maximum of one private resource file.

Currently, only Natural dialogs have a private resource file. This file is used to store the configuration of ActiveX controls that are defined in a dialog and are configured with their own property pages.

### Example of Private Resources

The name of the private resource file of the dialog `MYDLG` is `MYDLG.NR3`.

Natural creates, modifies and deletes this file automatically as needed, when the dialog is created, modified, deleted, etc.

The private resource file is used to store binary data related to the dialog `MYDLG`.

## API for Processing Resources

---

In the library `SYSEXT`, the following application programming interface (API) exists, which gives user applications access to resources' unique user exit routines:

API	Purpose
USR4208N	Write, read, delete a resource by using short or long name.

# III

## Defining Fields

---

This part describes how you define the fields you wish to use in a program. These fields can be database fields and user-defined fields.

**Use and Structure of `DEFINE DATA` Statement**

**User-Defined Variables**

**Function Call**

**Introduction to Dynamic Variables and Fields**

**Using Dynamic and Large Variables**

**User-Defined Constants**

**Initial Values (and the `RESET` Statement)**

**Redefining Fields**

**Arrays**

**X-Arrays**

Please note that only the major options of the `DEFINE DATA` statement are discussed here. Further options are described in the *Statements* documentation.

The particulars of database fields are described in *Accessing Data in an Adabas Database*. On principle, the features and examples described there for Adabas also apply to other database management systems. Differences, if any, are described in the relevant database interface documentation and in the *Statements* documentation or *Parameter Reference*.



# 12 Use and Structure of DEFINE DATA Statement

---

- Field Definitions in DEFINE DATA Statement ..... 74
- Defining Fields within a DEFINE DATA Statement ..... 74
- Defining Fields in a Separate Data Area ..... 75
- Structuring a DEFINE DATA Statement Using Level Numbers ..... 75

The first statement in a Natural program written in **structured mode** must always be a `DEFINE DATA` statement which is used to define fields for use in a program.

## Field Definitions in DEFINE DATA Statement

---

In the `DEFINE DATA` statement, you define all the fields - database fields as well as user-defined variables - that are to be used in the program.

There are two ways to define the fields:

- The fields can be defined within the `DEFINE DATA` statement itself (see **below**).
- The fields can be defined outside the program in a **local or global data area**, with the `DEFINE DATA` statement referencing that data area (see **below**).

If fields are used by multiple programs/routines, they should be defined in a data area outside the programs.

For a clear application structure, it is usually better to define fields in data areas outside the programs.

Data areas are created and maintained with the source editor.

In the **first example** below, the fields are defined within the `DEFINE DATA` statement of the program. In the **second example**, the same fields are defined in a **local data area (LDA)**, and the `DEFINE DATA` statement only contains a reference to that data area.

## Defining Fields within a DEFINE DATA Statement

---

The following example illustrates how fields can be defined within the `DEFINE DATA` statement itself:

```
DEFINE DATA LOCAL
1 VIEWEMP VIEW OF EMPLOYEES
  2 NAME
  2 FIRST-NAME
  2 PERSONNEL-ID
1 #VARI-A (A20)
1 #VARI-B (N3.2)
1 #VARI-C (I4)
END-DEFINE
...
```



## Defining Fields in a Separate Data Area

The following example illustrates how fields can be defined in a **local data area** (LDA):

Program:

```
DEFINE DATA LOCAL
  USING LDA39
END-DEFINE
... ↵
```

Local Data Area LDA39:

I	T	L	Name	F	Leng	Index/Init/EM/Name/Comment
V	1		VIEWEMP			EMPLOYEES
	2		NAME	A	20	
	2		FIRST-NAME	A	20	
	2		PERSONNEL-ID	A	8	
	1		#VARI-A	A	20	
	1		#VARI-B	N	3.2	
	1		#VARI-C	I	4	

↵

## Structuring a DEFINE DATA Statement Using Level Numbers

The following topics are covered:

- [Structuring and Grouping Your Definitions](#)
- [Level Numbers in View Definitions](#)
- [Level Numbers in Field Groups](#)
- [Level Numbers in Redefinitions](#)

### Structuring and Grouping Your Definitions

Level numbers are used within the `DEFINE DATA` statement to indicate the structure and grouping of the definitions. This is relevant with:

- **view definitions**
- **field groups**
- **redefinitions**

Level numbers are 1- or 2-digit numbers in the range from 01 to 99 (the leading zero is optional).

Generally, variable definitions are on Level 1.

The level numbering in view definitions, redefinitions and groups must be sequential; no level numbers may be skipped.

### Level Numbers in View Definitions

If you define a view, the specification of the view name must be on Level 1, and the fields the view is comprised of must be on Level 2. (For details on view definitions, see [Database Access](#).)

#### Example of Level Numbers in View Definition:

```
DEFINE DATA LOCAL
1 VIEWEMP VIEW OF EMPLOYEES
  2 NAME
  2 FIRST-NAME
  2 BIRTH
  ...
END-DEFINE
```

### Level Numbers in Field Groups

The definition of groups provides a convenient way of referencing a series of consecutive fields. If you define several fields under a common group name, you can reference the fields later in the program by specifying only the group name instead of the names of the individual fields.

The group name must be specified on Level 1, and the fields contained in the group must be one level lower.

For group names, the same naming conventions apply as for user-defined variables.

#### Example of Level Numbers in Group:

```
DEFINE DATA LOCAL
1 #FIELDA (N2.2)
1 #FIELDB (I4)
1 #GROUPA
  2 #FIELDC (A20)
  2 #FIELD D (A10)
  2 #FIELDE (N3.2)
1 #FIELD F (A2)
  ...
END-DEFINE ↵
```

In this example, the fields #FIELD C, #FIELD D and #FIELDE are defined under the common group name #GROUPA. The other three fields are not part of the group. Note that #GROUPA only serves as a group name and is not a field in its own right (and therefore does not have a format/length definition).

## Level Numbers in Redefinitions

If you redefine a field, the `REDEFINE` option must be on the same level as the original field, and the fields resulting from the redefinition must be one level lower. For details on redefinitions, see [Redefining Fields](#).

### Example of Level Numbers in Redefinition:

```
DEFINE DATA LOCAL
1 VIEWEMP VIEW OF STAFFDDM
  2 BIRTH
  2 REDEFINE BIRTH
    3 #YEAR-OF-BIRTH (N4)
    3 #MONTH-OF-BIRTH (N2)
    3 #DAY-OF-BIRTH (N2)
1 #FIELDA (A20)
1 REDEFINE #FIELDA
  2 #SUBFIELD1 (N5)
  2 #SUBFIELD2 (A10)
  2 #SUBFIELD3 (N5)
...
END-DEFINE ↵
```

In this example, the database field `BIRTH` is redefined as three user-defined variables, and the user-defined variable `#FIELDA` is redefined as three other user-defined variables.



# 13

## User-Defined Variables

---

▪ Definition of Variables .....	80
▪ Referencing of Database Fields Using (r) Notation .....	81
▪ Renumbering of Source-Code Line Number References .....	82
▪ Format and Length of User-Defined Variables .....	83
▪ Special Formats .....	84
▪ Index Notation .....	86
▪ Referencing a Database Array .....	89
▪ Referencing the Internal Count for a Database Array (C* Notation) .....	97
▪ Qualifying Data Structures .....	100
▪ Examples of User-Defined Variables .....	101

User-defined variables are fields which you define yourself in a program. They are used to store values or intermediate results obtained at some point in program processing for additional processing or display.

See also *Naming Conventions for User-Defined Variables* in *Using Natural*.

## Definition of Variables

---

You define a user-defined variable by specifying its name and its format/length in the `DEFINE DATA` statement.

You define the characteristics of a variable with the following notation:

```
(r,format-length/index)
```

This notation follows the variable name, optionally separated by one or more blanks.

No blanks are allowed between the individual elements of the notation.

The individual elements may be specified selectively as required, but when used together, they must be separated by the characters as indicated above.

Example:

In this example, a user-defined variable of alphanumeric format and a length of 10 positions is defined with the name `#FIELD1`.

```
DEFINE DATA LOCAL  
1 #FIELD1 (A10)  
...  
END-DEFINE
```



### Notes:

1. If operating in structured mode or if a program contains a `DEFINE DATA LOCAL` clause, variables cannot be defined dynamically in a statement.
2. This does not apply to application-independent variables (AIVs); see also *Defining Application-Independent Variables*

## Referencing of Database Fields Using (r) Notation

A statement label or the source-code line number can be used to refer to a previous Natural statement. This can be used to override Natural's default referencing (as described for each statement, where applicable), or for documentation purposes. See also [Loop Processing](#), [Referencing Statements within a Program](#).

The following topics are covered below:

- [Default Referencing of Database Fields](#)
- [Referencing with Statement Labels](#)
- [Referencing with Source-Code Line Numbers](#)

### Default Referencing of Database Fields

Generally, the following applies if you specify no statement reference notation:

- By default, the innermost active database loop (FIND, READ or HISTOGRAM) in which the database field in question has been read is referenced.
- If the field is not read in any active database loop, the last previous GET statement (in reporting mode also FIND FIRST or FIND UNIQUE statement) is referenced which is not contained in an already closed loop and which has read the field.

### Referencing with Statement Labels

Any Natural statement which causes a processing loop to be initiated and/or causes data elements to be accessed in the database may be marked with a symbolic label for subsequent referencing.

A label may be specified either in the form *label*. before the referencing object or in parentheses (*label*.) after the referencing object (but not both simultaneously).

The naming conventions for labels are identical to those for variables. The period after the label name serves to identify the entry as a label.

Example:

```

...
RD. READ PERSON-VIEW BY NAME STARTING FROM 'JONES'
  FD. FIND AUTO-VIEW WITH PERSONNEL-ID = PERSONNEL-ID (FD.)
    DISPLAY NAME (RD.) FIRST-NAME (RD.) MAKE (FD.)
  END-FIND
END-READ
...

```

## Referencing with Source-Code Line Numbers

A statement may also be referenced by using the number of the source-code line in which the statement is located.

All four digits of the line number must be specified (leading zeros must not be omitted).

Example:

```
...
0110 FIND EMPLOYEES-VIEW WITH NAME = 'SMITH'
0120   FIND VEHICLES-VIEW WITH MODEL = 'FORD'
0130     DISPLAY NAME (0110) MODEL (0120)
0140   END-FIND
0150 END-FIND
...
```

## Renumbering of Source-Code Line Number References

---

Numeric four-digit source-code line numbers that reference a statement (see [Referencing of Database Fields Using \(r\) Notation](#) and also [Referencing Statements within a Program](#)) are also renumbered if the Natural source program is renumbered. For the user's convenience and to aid in readability and debugging, all source code line number references that occur in a statement, an alphanumeric constant or a comment are renumbered. The position of the source code line number reference in the statement or alphanumeric constant (start, middle, end) does not matter.

The following patterns are recognized as being a valid source code line number reference and are renumbered (*nnnn* is a four-digit number):

Pattern	Sample Statement
( <i>nnnn</i> )	ESCAPE BOTTOM (0150)
( <i>nnnn</i> /	DISPLAY ADDRESS-LINE(0010/1:5)
( <i>nnnn</i> ,	DISPLAY NAME(0010,A10/1:5)

If the left parenthesis or the four-digit number *nnnn* is followed by a blank, or the four-digit number *nnnn* is followed by a period, the pattern is not considered to be a valid source code line number reference.

To avoid that a four-digit number that is contained in an alphanumeric constant is unintentionally renumbered, the constant should be split up and the different parts should be concatenated to form a single value by use of a hyphen.

Example:



```
Z := 'XXXX (1234,00) YYYY'
```

should be replaced by

```
Z := 'XXXX (1234' - ',00) YYYY'
```

## Format and Length of User-Defined Variables

Format and length of a user-defined variable are specified in parentheses after the variable name.

Fixed-length variables can be defined with the following formats and corresponding lengths.

For the definition of Format and Length in dynamic variables, see [Definition of Dynamic Variables](#).

Format	Explanation	Definable Length	Internal Length (in Bytes)
<b>A</b>	Alphanumeric	1 - 1073741824 (1GB)	1 - 1073741824
<b>B</b>	Binary	1 - 1073741824 (1GB)	1 - 1073741824
<b>C</b>	Attribute Control	-	2
<b>D</b>	Date	-	4
<b>F</b>	Floating Point	4 or 8	4 or 8
<b>I</b>	Integer	1, 2 or 4	1, 2 or 4
<b>L</b>	Logical	-	1
<b>N</b>	Numeric (unpacked)	1 - 29	1 - 29
<b>P</b>	Packed numeric	1 - 29	1 - 15
<b>T</b>	Time	-	7
<b>U</b>	Unicode (UTF-16)	1 - 536870912 (0.5 GB)	2 - 1073741824

Length can only be specified if format is specified. With some formats, the length need not be explicitly specified (as shown in the table above).

For fields defined with format N or P, you can use decimal position notation in the form  $nn.m$ , where  $nn$  represents the number of positions before the decimal point, and  $m$  represents the number of positions after the decimal point. The sum of the values of  $nn$  and  $m$  must not exceed 29, and the value of  $m$  must not exceed 7.



### Notes:

1. When a user-defined variable of format P is output with a DISPLAY, WRITE, or INPUT statement, Natural internally converts the format to N for the output.

2. In reporting mode, if format and length are not specified for a user-defined variable, the default format/length N7 will be used, unless this default assignment has been disabled by the profile/session parameter FS.

For a database field, the format/length as defined for the field in the data definition module (DDM) apply. (In reporting mode, it is also possible to define in a program a different format/length for a database field.)

In structured mode, format and length may only be specified in a data area definition or with a `DEFINE DATA` statement.

### Example of Format/Length Definition - Structured Mode:

```
DEFINE DATA LOCAL
1 EMPLOY-VIEW VIEW OF EMPLOYEES
  2 NAME
  2 FIRST-NAME
1 #NEW-SALARY (N6.2)
END-DEFINE
...
FIND EMPLOY-VIEW ...
...
COMPUTE #NEW-SALARY = ...
...
```

In reporting mode, format/length may be defined within the body of the program, if no `DEFINE DATA` statement is used.

### Example of Format/Length Definition - Reporting Mode:

```
...
...
FIND EMPLOYEES
... .. COMPUTE #NEW-SALARY(N6.2) = ...
...
```

## Special Formats

---

In addition to the standard alphanumeric (A) and numeric (B, F, I, N, P) formats, Natural supports the following special formats:

- [Format C - Attribute Control](#)
- [Formats D - Date, and T - Time](#)
- [Format L - Logical](#)

- [Format: Handle](#)

### Format C - Attribute Control

A variable defined with format C may be used to assign attributes dynamically to a field used in a DISPLAY, INPUT, PRINT, PROCESS PAGE or WRITE statement.

For a variable of format C, no length can be specified. The variable is always assigned a length of 2 bytes by Natural.

Example:

```
DEFINE DATA LOCAL
1 #ATTR (C)
1 #A (N5)
END-DEFINE
...
MOVE (AD=I CD=RE) TO #ATTR
INPUT #A (CV=#ATTR)
...
```

For further information, see the session parameter CV.

### Formats D - Date, and T - Time

Variables defined with formats D and T can be used for date and time arithmetic and display. Format D can contain date information only. Format T can contain date and time information; in other words, date information is a subset of time information. Time is counted in tenths of seconds.

For variables of formats D and T, no length can be specified. A variable with format D is always assigned a length of 4 bytes (P6) and a variable of format T is always assigned a length of 7 bytes (P12) by Natural. If the profile parameter MAXYEAR is set to 9999, a variable with format D is always assigned a length of 4 bytes (P7) and a variable of format T is always assigned a length of 7 bytes (P13) by Natural.

Example:

```
DEFINE DATA LOCAL
1 #DAT1 (D)
END-DEFINE
*
MOVE *DATX TO #DAT1
ADD 7 TO #DAT1
WRITE '=' #DAT1
END
```

For further information, see the session parameter EM and the system variables \*DATX and \*TIMX.

The value in a date field must be in the range from 1st January 1582 to 31st December 2699.

### Format L - Logical

A variable defined of format L may be used as a logical condition criterion. It can take the value TRUE or FALSE.

For a variable of format L, no length can be specified. A variable of format L is always assigned a length of 1 byte by Natural.

Example:

```
DEFINE DATA LOCAL
1 #SWITCH(L)
END-DEFINE
MOVE TRUE TO #SWITCH
...
IF #SWITCH
...
MOVE FALSE TO #SWITCH
ELSE
...
MOVE TRUE TO #SWITCH
END-IF
```

For further information on logical value presentation, see the session parameter EM.

### Format: Handle

A variable defined as HANDLE OF OBJECT can be used as an object handle.

## Index Notation

---

An index notation is used for fields that represent an array.

An integer numeric constant or user-defined variable may be used in index notations. A user-defined variable can be specified using one of the following formats: N (numeric), P (packed), I (integer) or B (binary), where format B may be used only with a length of less than or equal to 4.

A system variable, system function or qualified variable cannot be used in index notations.

**Array Definition - Examples:**

1. #ARRAY (3)  
Defines a one-dimensional array with three occurrences.
2. FIELD ( label.,A20/5) **or** label.FIELD(A20/5)  
Defines an array from a database field referencing the statement marked by *label.* with format alphanumeric, length 20 and 5 occurrences.
3. #ARRAY (N7.2/1:5,10:12,1:4)  
Defines an array with format/length N7.2 and three array dimensions with 5 occurrences in the first, 3 occurrences in the second and 4 occurrences in the third dimension.
4. FIELD ( label./i:i + 5) **or** label.FIELD(i:i + 5)  
Defines an array from a database field referencing the statement marked by *label..*

FIELD represents a multiple-value field or a field from a periodic group where *i* specifies the offset index within the database occurrence. The size of the array within the program is defined as 6 occurrences (*i*:*i* + 5). The database offset index is specified as a variable to allow for the positioning of the program array within the occurrences of the multiple-value field or periodic group. For any repositioning of *i*, a new access must be made to the database using a GET or GET SAME statement.

Natural allows for the definition of arrays where the index does not have to begin with 1. At runtime, Natural checks that index values specified in the reference do not exceed the maximum size of dimensions as specified in the definition.

**Notes:**

1. For compatibility with earlier Natural versions, an array range may be specified using a hyphen (-) instead of a colon (:).
2. A mix of both notations, however, is *not* permitted.
3. The hyphen notation is only allowed in reporting mode (but *not* in a DEFINE DATA statement).

The maximum index value is 1,073,741,824. The maximum size of a data area per programming object is 1,073,741,824 bytes (1 GB).

Simple arithmetic expressions using the plus (+) and minus (-) operators may be used in index references. When arithmetic expressions are used as indices, these operators must be preceded and followed by a blank.

Arrays in group structures are resolved by Natural field by field, not group occurrence by group occurrence.

**Example of Group Array Resolution:**

```
DEFINE DATA LOCAL
1 #GROUP (1:2)
  2 #FIELDA (A5/1:2)
  2 #FIELDB (A5)
END-DEFINE
...
```

If the group defined above were output in a WRITE statement:

```
WRITE #GROUP (*)
```

the occurrences would be output in the following order:

```
#FIELDA(1,1) #FIELDA(1,2) #FIELDA(2,1) #FIELDA(2,2) #FIELDB(1) #FIELDB(2)
```

and *not*:

```
#FIELDA(1,1) #FIELDA(1,2) #FIELDB(1) #FIELDA(2,1) #FIELDA(2,2) #FIELDB(2)
```

**Array Referencing - Examples:**

1. #ARRAY (1)  
References the first occurrence of a one-dimensional array.
2. #ARRAY (7:12)  
References the seventh to twelfth occurrence of a one-dimensional array.
3. #ARRAY (i + 5)  
References the i+fifth occurrence of a one-dimensional array.
4. #ARRAY (5,3:7,1:4)  
Reference is made within a three dimensional array to occurrence 5 in the first dimension, occurrences 3 to 7 (5 occurrences) in the second dimension and 1 to 4 (4 occurrences) in the third dimension.
5. An asterisk may be used to reference all occurrences within a dimension:

```
DEFINE DATA LOCAL
1 #ARRAY1 (N5/1:4,1:4)
1 #ARRAY2 (N5/1:4,1:4)
END-DEFINE
...
ADD #ARRAY1 (2,*) TO #ARRAY2 (4,*)
... ←
```

## Using a Slash before an Array Occurrence

If a variable name is followed by a 4-digit number enclosed in parentheses, Natural interprets this number as a line-number reference to a statement. Therefore a 4-digit array occurrence must be preceded by a slash (/) to indicate that it is an array occurrence; for example:

```
#ARRAY (/1000)
```

not:

```
#ARRAY (1000)
```

because the latter would be interpreted as a reference to source code line 1000.

If an index variable name could be misinterpreted as a format/length specification, a slash (/) must be used to indicate that an index is being specified. If, for example, the occurrence of an array is defined by the value of the variable N7, the occurrence must be specified as:

```
#ARRAY (/N7)
```

not:

```
#ARRAY (N7)
```

because the latter would be misinterpreted as the definition of a 7-byte numeric field.

## Referencing a Database Array

The following topics are covered below:

- [Referencing Multiple-Value Fields and Periodic-Group Fields](#)
- [Referencing Arrays Defined with Constants](#)
- [Referencing Arrays Defined with Variables](#)
- [Referencing Multiple-Defined Arrays](#)



**Note:** Before executing the following example programs, please run the program `INDEXTST` in the library `SYSEXP` to create an example record that uses 10 different language codes.

## Referencing Multiple-Value Fields and Periodic-Group Fields

A multiple-value field or periodic-group field within a view/DDM may be defined and referenced using various index notations.

For example, the first to tenth values and the Ith to Ith+10 values of the same multiple-value field/periodic-group field of a database record:

```
DEFINE DATA LOCAL
1 I (I2)
1 EMPLOY-VIEW VIEW OF EMPLOYEES
  2 LANG (1:10)
  2 LANG (I:I+10)
END-DEFINE
```

or:

```
RESET I (I2)
...
READ EMPLOYEES
OBTAIN LANG(1:10) LANG(I:I+10)
```



### Notes:

1. The same lower bound index may only be used once per array (this applies to constant indexes as well as variable indexes).
2. For an array definition using a variable index, the lower bound must be specified using the variable by itself, and the upper bound must be specified using the same variable plus a constant.

## Referencing Arrays Defined with Constants

An array defined with constants may be referenced using either constants or variables. The upper bound of the array cannot be exceeded. The upper bound will be checked by Natural at compilation time if a constant is used.

### Reporting Mode Example:

```
** Example 'INDEX1R': Array definition with constants (reporting mode)
*****
*
READ (1) EMPLOYEES WITH NAME = 'WINTER' WHERE CITY = 'LONDON'
  OBTAIN LANG (1:10)
  /*
  WRITE 'LANG(1:10):' LANG (1:10) //
  WRITE 'LANG(1)   :' LANG (1)   / 'LANG(5:9) :' LANG (5:9)
LOOP
*
END
```



**Structured Mode Example:**

```

** Example 'INDEX1S': Array definition with constants (structured mode)
*****
DEFINE DATA LOCAL
1 EMPLOY-VIEW VIEW OF EMPLOYEES
  2 NAME
  2 FIRST-NAME
  2 CITY
  2 LANG (1:10)
END-DEFINE
*
READ (1) EMPLOY-VIEW WITH NAME = 'WINTER' WHERE CITY = 'LONDON'
  WRITE 'LANG(1:10):' LANG (1:10) //
  WRITE 'LANG(1)   :' LANG (1)   / 'LANG(5:9) :' LANG (5:9)
END-READ
END

```

If a multiple-value field or periodic-group field is defined several times using constants and is to be referenced using variables, the following syntax is used.

**Reporting Mode Example:**

```

** Example 'INDEX2R': Array definition with constants (reporting mode)
**                                     (multiple definition of same database field)
*****
DEFINE DATA LOCAL
1 EMPLOY-VIEW VIEW OF EMPLOYEES
  2 NAME
  2 CITY
  2 LANG (1:5)
  2 LANG (4:8)
END-DEFINE
*
READ (1) EMPLOY-VIEW WITH NAME = 'WINTER' WHERE CITY = 'LONDON'
  DISPLAY 'NAME'           NAME
          'LANGUAGE/1:3' LANG (1.1:3)
          'LANGUAGE/6:8' LANG (4.3:5)
LOOP
*
END

```

**Structured Mode Example:**

```
** Example 'INDEX2S': Array definition with constants (structured mode)
**          (multiple definition of same database field)
*****
DEFINE DATA LOCAL
1 EMPLOY-VIEW VIEW OF EMPLOYEES
  2 NAME
  2 CITY
  2 LANG (1:5)
  2 LANG (4:8)
END-DEFINE
*
READ (1) EMPLOY-VIEW WITH NAME = 'WINTER' WHERE CITY = 'LONDON'
  DISPLAY 'NAME'          NAME
          'LANGUAGE/1:3' LANG (1.1:3)
          'LANGUAGE/6:8' LANG (4.3:5)
END-READ
*
END
```

**Referencing Arrays Defined with Variables**

Multiple-value fields or periodic-group fields in arrays defined with variables must be referenced using the same variable.

**Reporting Mode Example:**

```
** Example 'INDEX3R': Array definition with variables (reporting mode)
*****
RESET I (I2)
*
I := 1
READ (1) EMPLOYEES WITH NAME = 'WINTER' WHERE CITY = 'LONDON'
  OBTAIN LANG (I:I+10)
  /*
  WRITE 'LANG(I)          :' LANG (I) /
        'LANG(I+5:I+7):' LANG (I+5:I+7)
LOOP
*
END
```

**Structured Mode Example:**

```

** Example 'INDEX3S': Array definition with variables (structured mode)
*****
DEFINE DATA LOCAL
1 I (I2)
*
1 EMPLOY-VIEW VIEW OF EMPLOYEES
  2 NAME
  2 CITY
  2 LANG (I:I+10)
END-DEFINE
*
I := 1
READ (1) EMPLOY-VIEW WITH NAME = 'WINTER' WHERE CITY = 'LONDON'
  WRITE 'LANG(I)      :' LANG (I) /
        'LANG(I+5:I+7):' LANG (I+5:I+7)
END-READ
END

```

If a different index is to be used, an unambiguous reference to the first encountered definition of the array with variable index must be made. This is done by qualifying the index expression as shown below.

**Reporting Mode Example:**

```

** Example 'INDEX4R': Array definition with variables (reporting mode)
*****
RESET I (I2) J (I2)
*
I := 2
J := 3
*
READ (1) EMPLOYEES WITH NAME = 'WINTER' WHERE CITY = 'LONDON'
  OBTAIN LANG (I:I+10)
  /*
  WRITE 'LANG(I.J)   :' LANG (I.J) /
        'LANG(I.1:5):' LANG (I.1:5)
LOOP
*
END

```

**Structured Mode Example:**

```

** Example 'INDEX4S': Array definition with variables (structured mode)
*****
DEFINE DATA LOCAL
1 I (I2)
1 J (I2)
1 EMPLOY-VIEW VIEW OF EMPLOYEES
  2 NAME
  2 CITY
  2 LANG (I:I+10)
END-DEFINE
*
I := 2
J := 3
READ (1) EMPLOY-VIEW WITH NAME = 'WINTER' WHERE CITY = 'LONDON'
  WRITE 'LANG(I.J)  :' LANG (I.J) /
        'LANG(I.1:5):' LANG (I.1:5)
END-READ
END

```

The expression `I .` is used to create an unambiguous reference to the array definition and “positions” to the first value within the read array range (`LANG(I.1:5)`).

The current content of `I` at the time of the database access determines the starting occurrence of the database array.

**Referencing Multiple-Defined Arrays**

For multiple-defined arrays, a reference with qualification of the index expression is usually necessary to ensure an unambiguous reference to the desired array range.

**Reporting Mode Example:**

```

** Example 'INDEX5R': Array definition with constants (reporting mode)
**
** (multiple definition of same database field)
*****
DEFINE DATA LOCAL                                /* For reporting mode programs
1 EMPLOY-VIEW VIEW OF EMPLOYEES                    /* DEFINE DATA is recommended
  2 NAME                                           /* to use multiple definitions
  2 CITY                                           /* of same database field
  2 LANG (1:10)
  2 LANG (5:10)
*
1 I (I2)
1 J (I2)
END-DEFINE
*
I := 1
J := 2

```

```

*
READ (1) EMPLOY-VIEW WITH NAME = 'WINTER' WHERE CITY = 'LONDON'
  WRITE 'LANG(1.1:10) :' LANG (1.1:10) /
        'LANG(1.I:I+2):' LANG (1.I:I+2) //
  WRITE 'LANG(5.1:5)   :' LANG (5.1:5) /
        'LANG(5.J)     :' LANG (5.J)
LOOP
END

```

### Structured Mode Example:

```

** Example 'INDEX5S': Array definition with constants (structured mode)
**                               (multiple definition of same database field)
*****
DEFINE DATA LOCAL
1 EMPLOY-VIEW VIEW OF EMPLOYEES
  2 NAME
  2 CITY
  2 LANG (1:10)
  2 LANG (5:10)
*
1 I (I2)
1 J (I2)
END-DEFINE
*
*
I := 1
J := 2
*
READ (1) EMPLOY-VIEW WITH NAME = 'WINTER' WHERE CITY = 'LONDON'
  WRITE 'LANG(1.1:10) :' LANG (1.1:10) /
        'LANG(1.I:I+2):' LANG (1.I:I+2) //
  WRITE 'LANG(5.1:5)   :' LANG (5.1:5) /
        'LANG(5.J)     :' LANG (5.J)
END-READ
END

```

A similar syntax is also used if multiple-value fields or periodic-group fields are defined using index variables.

### Reporting Mode Example:

```

** Example 'INDEX6R': Array definition with variables (reporting mode)
**                               (multiple definition of same database field)
*****
DEFINE DATA LOCAL
1 I (I2) INIT <1>
1 J (I2) INIT <2>
1 N (I2) INIT <1>
1 EMPLOY-VIEW VIEW OF EMPLOYEES      /* For reporting mode programs
  2 NAME                             /* DEFINE DATA is recommended

```

```

2 CITY                                /* to use multiple definitions
2 LANG (I:I+10)                       /* of same database field
2 LANG (J:J+5)
2 LANG (4:5)
*
END-DEFINE
*
READ (1) EMPLOY-VIEW WITH NAME = 'WINTER' WHERE CITY = 'LONDON'
*
WRITE 'LANG(I.I)      :' LANG (I.I) /
      'LANG(1.I:I+2):' LANG (I.I:I+10) //
*
WRITE 'LANG(J.N)      :' LANG (J.N) /
      'LANG(J.2:4)   :' LANG (J.2:4) //
*
WRITE 'LANG(4.N)      :' LANG (4.N) /
      'LANG(4.N:N+1):' LANG (4.N:N+1) /
LOOP
END

```

### Structured Mode Example:

```

** Example 'INDEX6S': Array definition with variables (structured mode)
**                               (multiple definition of same database field)
*****
DEFINE DATA LOCAL
1 I (I2) INIT <1>
1 J (I2) INIT <2>
1 N (I2) INIT <1>
1 EMPLOY-VIEW VIEW OF EMPLOYEES
  2 NAME
  2 CITY
  2 LANG (I:I+10)
  2 LANG (J:J+5)
  2 LANG (4:5)
*
END-DEFINE
*
READ (1) EMPLOY-VIEW WITH NAME = 'WINTER' WHERE CITY = 'LONDON'
*
WRITE 'LANG(I.I)      :' LANG (I.I) /
      'LANG(1.I:I+2):' LANG (I.I:I+10) //
*
WRITE 'LANG(J.N)      :' LANG (J.N) /
      'LANG(J.2:4)   :' LANG (J.2:4) //
*
WRITE 'LANG(4.N)      :' LANG (4.N) /
      'LANG(4.N:N+1):' LANG (4.N:N+1) /
END-READ
END

```

## Referencing the Internal Count for a Database Array (C\* Notation)

It is sometimes necessary to reference a multiple-value field and/or a periodic group without knowing how many values/occurrences exist in a given record. Adabas maintains an internal count of the number of values of each multiple-value field and the number of occurrences of each periodic group. This count may be referenced by specifying C\* immediately before the field name.

### Note concerning databases other than Adabas:

The explicit format and length permitted to declare a C\* field is either

- integer (I) with a length of 2 bytes (I2) or 4 bytes (I4),
- numeric (N) or packed (P) with only integer (but no precision) digits; for example (N3).

If no explicit format and length is supplied, format/length (N3) is assumed as default.

### Examples:

C*LANG	Returns the count of the number of values for the multiple-value field LANG.
C*INCOME	Returns the count of the number of occurrences for the periodic group INCOME.
C*BONUS(1)	Returns the count of the number of values for the multiple-value field BONUS in periodic group occurrence 1 (assuming that BONUS is a multiple-value field within a periodic group.)

### Example Program Using the C\* Variable:

```
** Example 'CNOTX01': C* Notation
*****
DEFINE DATA LOCAL
1 EMPL-VIEW VIEW OF EMPLOYEES
  2 NAME
  2 CITY
  2 C*INCOME
  2 INCOME
    3 SALARY (1:5)
    3 C*BONUS (1:2)
    3 BONUS (1:2,1:2)
  2 C*LANG
  2 LANG (1:2)
*
1 #I (N1)
END-DEFINE
*
LIMIT 2
READ EMPL-VIEW BY CITY
/*
WRITE NOTITLE 'NAME:' NAME /
```

```

        'NUMBER OF LANGUAGES SPOKEN:' C*LANG 5X
        'LANGUAGE 1:' LANG (1) 5X
        'LANGUAGE 2:' LANG (2)
/*
WRITE 'SALARY DATA:'
FOR #I FROM 1 TO C*INCOME
    WRITE 'SALARY' #I SALARY (1.#I)
END-FOR
/*
WRITE 'THIS YEAR BONUS:' C*BONUS(1) BONUS (1,1) BONUS (1,2)
    / 'LAST YEAR BONUS:' C*BONUS(2) BONUS (2,1) BONUS (2,2)
SKIP 1
END-READ
END

```

**Output of Program CNOTX01:**

```

NAME: SENKO
NUMBER OF LANGUAGES SPOKEN:      1      LANGUAGE 1: ENG      LANGUAGE 2:
SALARY DATA:
SALARY  1      36225
SALARY  2      29900
SALARY  3      28100
SALARY  4      26600
SALARY  5      25200
THIS YEAR BONUS:   0          0          0
LAST YEAR BONUS:  0          0          0

NAME: CANALE
NUMBER OF LANGUAGES SPOKEN:      2      LANGUAGE 1: FRE      LANGUAGE 2: ENG
SALARY DATA:
SALARY  1      202285
THIS YEAR BONUS:   1      23000          0
LAST YEAR BONUS:  0          0          0

```

**C\* for Multiple-Value Fields Within Periodic Groups**

For a multiple-value field within a periodic group, you can also define a C\* variable with an index range specification.

The following examples use the multiple-value field BONUS, which is part of the periodic group INCOME. All three examples yield the same result.



**Example 1 - Reporting Mode:**

```

** Example 'CNOTX02': C* Notation (multiple-value fields)
*****
*
LIMIT 2
READ EMPLOYEES BY CITY
  OBTAIN C*BONUS (1:3)
        BONUS   (1:3,1:3)
/*
  DISPLAY NAME C*BONUS (1:3) BONUS (1:3,1:3)
LOOP
*
END

```

**Example 2 - Structured Mode:**

```

** Example 'CNOTX03': C* Notation (multiple-value fields)
*****
DEFINE DATA LOCAL
1 EMPL-VIEW VIEW OF EMPLOYEES
  2 NAME
  2 CITY
  2 INCOME   (1:3)
    3 C*BONUS
    3 BONUS   (1:3)
END-DEFINE
*
LIMIT 2
READ EMPL-VIEW BY CITY
/*
  DISPLAY NAME C*BONUS (1:3) BONUS (1:3,1:3)
END-READ
*
END

```

**Example 3 - Structured Mode:**

```

** Example 'CNOTX04': C* Notation (multiple-value fields)
*****
DEFINE DATA LOCAL
1 EMPL-VIEW VIEW OF EMPLOYEES
  2 NAME
  2 CITY
  2 C*BONUS (1:3)
  2 INCOME  (1:3)
    3 BONUS (1:3)
END-DEFINE
*
LIMIT 2
READ EMPL-VIEW BY CITY

```

```
/*
  DISPLAY NAME C*BONUS (*) BONUS (*,*)
END-READ
*
END
```

 **Caution:** As the Adabas format buffer does not permit ranges for count fields, they are generated as individual fields; therefore a C\* index range for a large array may cause an Adabas format buffer overflow.

## Qualifying Data Structures

---

To identify a field when referencing it, you may qualify the field; that is, before the field name, you specify the name of the level-1 data element in which the field is located and a period.

If a field cannot be identified uniquely by its name (for example, if the same field name is used in multiple groups/views), you must qualify the field when you reference it.

The combination of level-1 data element and field name must be unique.

### Example:

```
DEFINE DATA LOCAL
1 FULL-NAME
  2 LAST-NAME (A20)
  2 FIRST-NAME (A15)
1 OUTPUT-NAME
  2 LAST-NAME (A20)
  2 FIRST-NAME (A15)
END-DEFINE
...
MOVE FULL-NAME.LAST-NAME TO OUTPUT-NAME.LAST-NAME
...
```

The qualifier must be a level-1 data element.

### Example:

```
DEFINE DATA LOCAL
1 GROUP1
  2 SUB-GROUP
    3 FIELD1 (A15)
    3 FIELD2 (A15)
END-DEFINE
...
MOVE 'ABC' TO GROUP1.FIELD1
...
```

## Qualifying a Database Field:

If you use the same name for a user-defined variable and a database field (which you should not do anyway), you must qualify the database field when you want to reference it



**Caution:** If you do not qualify the database field when you want to reference it, the user-defined variable will be referenced instead.

## Examples of User-Defined Variables

```

DEFINE DATA LOCAL
1 #A1 (A10)      /* Alphanumeric, 10 positions.
1 #A2 (B4)       /* Binary, 4 positions.
1 #A3 (P4)       /* Packed numeric, 4 positions and 1 sign position.
1 #A4 (N7.2)     /* Unpacked numeric,
                /* 7 positions before and 2 after decimal point.
1 #A5 (N7.)      /* Invalid definition!!!
1 #A6 (P7.2)     /* Packed numeric, 7 positions before and 2 after decimal point
                /* and 1 sign position.
1 #INT1 (I1)     /* Integer, 1 byte.
1 #INT2 (I2)     /* Integer, 2 bytes.
1 #INT3 (I3)     /* Invalid definition!!!
1 #INT4 (I4)     /* Integer, 4 bytes.
1 #INT5 (I5)     /* Invalid definition!!!
1 #FLT4 (F4)     /* Floating point, 4 bytes.
1 #FLT8 (F8)     /* Floating point, 8 bytes.
1 #FLT2 (F2)     /* Invalid definition!!!
1 #DATE (D)      /* Date (internal format/length P6).
1 #TIME (T)      /* Time (internal format/length P12).
1 #SWITCH (L)    /* Logical, 1 byte (TRUE or FALSE).
                /*
END-DEFINE ↵

```



# 14      Function Call

---

▪ Calling User-Defined Functions .....	104
▪ Function Result .....	105
▪ Evaluation Sequence .....	105
▪ Restrictions .....	105
▪ Syntax Description .....	106
▪ Example .....	110

```
call-name  
( < [[prototype-cast] [intermediate-result-definition]] [parameter] [, [parameter]] ... > )  
[array-index-expression]
```

Related topics:

- Object type **Function**
- **User-defined Functions**
- `DEFINE FUNCTION` statement
- `DEFINE PROTOTYPE` statement

## Calling User-Defined Functions

---

A function call performs an invocation of a **user-defined function**, a special kind of a subroutine which is implemented in a separate programming object of type **function**.

Usually, a function call is provided with parameters and returns a result. It may be used within a Natural statement instead of a read-only operand. In this case, the function has to return a result, which is then processed by the statement like a field containing the same value.

It is also possible to use a function call stand-alone in place of a Natural statement. Then the function call need not return a result value.

There are different ways to call a function:

- [Symbolic Function Call](#)
- [Variable Function Call](#)

### Symbolic Function Call

When the specified *call-name* represents the name of the function to be executed, the function call is denoted as a *symbolic* function call. Be aware, the function name is defined in the `DEFINE FUNCTION` statement and does not necessarily have to match the name of the module in which the function is defined. The function interface result and parameter layouts used to resolve a function call are either specified by a `DEFINE PROTOTYPE` statement with the same name or loaded automatically if the cataloged version of the called function exists.

## Variable Function Call

A function can also be called in an indirect form, denoted as a *variable* function call. In this case, the specified *call-name* is an alphanumeric variable, which contains the name of the called function at execution time. This variable has to be referenced in a prototype definition (DEFINE PROTOTYPE statement) in conjunction with the keyword VARIABLE. If this prototype does not contain the right result layout or parameter layout, another prototype can be assigned with the (PT=) option.

## Function Result

According to the function definition, a function call may return a single result field. This can be a scalar value or an array field, which is processed like a temporary field in the statement where the function call is embedded. If the result is an array, the function call must be immediately followed by an *array-index-expression* addressing the required occurrences.

For example, to access the first occurrence of the array returned:

```
#FCT(<#A,#B>)(1)
```

## Evaluation Sequence

If a single or multiple function calls are used within a statement, the evaluation of all functions is performed in a separate step before the statement execution will be started. The function calls are executed in the same order in which they appear in the statement.

## Restrictions

Function calls are *not* allowed in the following situations:

- in positions where the operand value is changed by the Natural statement (for example, MOVE 1 TO #FCT(<..>));
- in a DEFINE DATA statement;
- in a database access statement (READ, FIND, SELECT, UPDATE, STORE, etc.);
- in an AT BREAK or IF BREAK statement;
- as an argument of Natural system functions (AVER, SUM, \*TRIM, etc.);
- as an array index notation;
- as a parameter of a function call.

If a function call is used in an `INPUT` statement, the return value will be treated like a constant value. This leads to an automatic assignment of attribute (`AD=0`) to make this field write-protected (for output only).

## Syntax Description

A function call may consist of the following syntax elements:

- `call-name`
- `prototype-cast`
- `intermediate-result-definition`
- `Parameter(s)`
- `array-index-expression`

### call-name

```
{
  function-name
  variable-name
}
```

Operand Definition Table:

Operand	Possible Structure	Possible Formats	Referencing Permitted	Dynamic Definition
<i>variable-name</i>	S A	A U	yes	no

Syntax Element Description:

Syntax Element	Description
<i>function-name</i>	<p><b>Function Name:</b></p> <p><i>function-name</i> is the name of the function to be called. Be aware, the function name is defined in the <code>DEFINE FUNCTION</code> statement and does not necessarily have to match the name of the module in which the function is defined. If a prototype with the same name has already been defined before, this prototype is used to pick up the function interface; that is, the result layout definition and the required parameters.</p>
<i>variable-name</i>	<p><b>Variable Function Name:</b></p> <p><i>variable-name</i> is the name of the variable containing the real name of the function to be called at runtime. In order to declare the call name as a variable name, a prototype with the same name, which is classified with keyword <code>VARIABLE</code>, must be defined before.</p>



**prototype-cast**

$$PT= \left\{ \begin{array}{l} \textit{prototype-name} \\ \textit{prototype-variable-name} \end{array} \right\}$$

For every function call, Natural tries to get information on the function result and the calling parameters. This leads to a search for a prototype with the same name as the call name. If such a prototype is not available or if this prototype does not contain the right result layout or parameter layout, another prototype can be linked to the function call with a (PT=) clause. In this case, the referenced prototype steps in place and is used to define the function result layout and the parameter layout. The calling mode (*symbolic* or *variable*) declared in the referenced prototype is ignored.

Syntax Element Description:

Syntax Element	Description
<i>prototype-name</i>	<p><b>Prototype Name:</b></p> <p><i>prototype-name</i> is the identifier of the prototype whose result and parameters layouts are to be used.</p>
<i>prototype-variable-name</i>	<p><b>Prototype Variable Name:</b></p> <p><i>prototype-variable-name</i> is the name of an alphanumeric field used as function name in a function call. At execution time it has to contain the name of the function to be called.</p> <p>The name has to follow the same rules which apply for a variable reference, including field qualification, but without array index references.</p>

**intermediate-result-definition**

$$IR= \left\{ \begin{array}{l} \textit{format-length} [\textit{array-definition}] \\ [(\textit{array-definition})] \text{ HANDLE OF OBJECT} \\ ( \left\{ \begin{array}{l} \textbf{A} \\ \textbf{U} \\ \textbf{B} \end{array} \right\} [\textit{array-definition}] \text{ DYNAMIC} \end{array} \right\}$$

This clause can be used to specify the *format-length/array-definition* of the return value for a function call without using an explicit or implicit prototype definition, that is, it enables the explicit specification of the function result layout. If a prototype is available for this function call or if the cataloged version of the called function exists, the result format given in the (IR=) clause is checked for move compatibility.

Syntax Element Description:

Syntax Element	Description
<i>format-length</i>	<p><b>Format/Length Definition:</b></p> <p>The format and length of the field.</p> <p>For information on format/length definition of user-defined variables, see <a href="#">Format and Length of User-Defined Variables</a>.</p>
<i>array-definition</i>	<p><b>Array Dimension Definition:</b></p> <p>With an <i>array-definition</i>, you define the lower and upper bounds of the dimensions in an array definition.</p> <p>See <i>Array Dimension Definition</i> in the <i>Statements</i> documentation.</p>
HANDLE OF OBJECT	<p><b>Handle of Object:</b></p> <p>Used in conjunction with NaturalX.</p>
A, B or U	<p><b>Data Format:</b></p> <p>Possible formats are alphanumeric, binary or Unicode for dynamic variables.</p>
DYNAMIC	<p><b>Dynamic Variable:</b></p> <p>A field may be defined as DYNAMIC.</p> <p>For further information on processing dynamic variables, see <a href="#">Introduction to Dynamic Variables and Fields</a>.</p>

### Parameter(s)

Parameters are the data values passed to the function. They can be provided as a constant value or a variable, depending on what is defined in the DEFINE DATA PARAMETER section of the function definition. The semantic and syntactic rules which apply to the function parameters are the same as described in the parameters section of subprograms; see *Parameters* in the description of the CALLNAT statement.

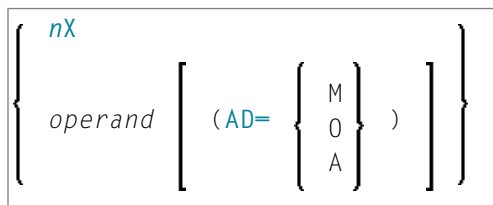

Operand Definition Table:

Operand	Possible Structure	Possible Formats	Referencing Permitted	Dynamic Definition
<i>operand</i>	C S A G	A N P I F B D T L C G O	yes	no

## Syntax Element Description:

Syntax Element	Description						
<i>nX</i>	<p><b>Parameters to be Skipped:</b></p> <p>With the notation <i>nX</i> you can specify that the next <i>n</i> parameters are to be skipped (for example, 1X to skip the next parameter, or 3X to skip the next three parameters); this means that for the next <i>n</i> parameters no values are passed to the function.</p> <p>A parameter that is to be skipped must be defined with the keyword <code>OPTIONAL</code> in the function's <code>DEFINE DATA PARAMETER</code> statement. <code>OPTIONAL</code> means that a value can - but need not - be passed from the invoking object to such a parameter.</p>						
AD=	<p><b>Attribute Definition:</b></p> <p>If <i>operand</i> is a variable, you can mark it in one of the following ways:</p> <table border="1"> <tbody> <tr> <td>AD=0</td> <td> <p><b>Non-modifiable:</b></p> <p>See session parameter AD=0.</p> <p><b>Note:</b> Internally, AD=0 is processed in the same way as <code>BY VALUE</code> (see the section <i>parameter-data-definition</i> in the description of the <code>DEFINE DATA</code> statement).</p> </td> </tr> <tr> <td>AD=M</td> <td> <p><b>Modifiable:</b></p> <p>See session parameter AD=M.</p> <p>This is the default setting.</p> </td> </tr> <tr> <td>AD=A</td> <td> <p><b>Input only:</b></p> <p>See session parameter AD=A.</p> </td> </tr> </tbody> </table> <p><b>Note:</b> If <i>operand</i> is a constant, the attribute definition AD cannot be explicitly specified. For constants, AD=0 always applies.</p>	AD=0	<p><b>Non-modifiable:</b></p> <p>See session parameter AD=0.</p> <p><b>Note:</b> Internally, AD=0 is processed in the same way as <code>BY VALUE</code> (see the section <i>parameter-data-definition</i> in the description of the <code>DEFINE DATA</code> statement).</p>	AD=M	<p><b>Modifiable:</b></p> <p>See session parameter AD=M.</p> <p>This is the default setting.</p>	AD=A	<p><b>Input only:</b></p> <p>See session parameter AD=A.</p>
AD=0	<p><b>Non-modifiable:</b></p> <p>See session parameter AD=0.</p> <p><b>Note:</b> Internally, AD=0 is processed in the same way as <code>BY VALUE</code> (see the section <i>parameter-data-definition</i> in the description of the <code>DEFINE DATA</code> statement).</p>						
AD=M	<p><b>Modifiable:</b></p> <p>See session parameter AD=M.</p> <p>This is the default setting.</p>						
AD=A	<p><b>Input only:</b></p> <p>See session parameter AD=A.</p>						

**array-index-expression**

If the result returned by the function call is an array, an index notation must be provided to address the demanded array occurrences.

For details, refer to *Index Notation* in *User-Defined Variables in the Programming Guide*.

**Example**

The example FUNCSEX01 uses the functions F#ADDITION, F#CHAR, F#EVEN and F#TEXT, which are defined in the sample functions FUNCSEX02, FUNCSEX03, FUNCSEX04 and FUNCSEX05.

```

** Example 'FUNCSEX01': Function call (Program)
*****
DEFINE DATA LOCAL
  1 #NUM (I2) INIT <5>
  1 #A (I2) INIT <1>
  1 #B (I2) INIT <2>
  1 #C (I2) INIT <3>
  1 #CHAR (A1) INIT <'A'>
END-DEFINE
*
IF #NUM = F#ADDITION(<#A,#B,#C>) /* Function with three parameters.
  WRITE 'Sum of #A,#B,#C' #NUM
ELSE
  IF #NUM = F#ADDITION(<1X,#B,#C>) /* Function with optional parameters.
    WRITE 'Sum of #B,#C' #NUM
  END-IF
END-IF
*
DECIDE ON FIRST #CHAR
  VALUE F#CHAR (<>)(1) /* Function with result array.
    WRITE 'Character A found'
  VALUE F#CHAR (<>)(2)
    WRITE 'Character B found'
  NONE
  IGNORE
END-DECIDE
*
IF F#EVEN(<#B>) /* Function with logical result value.
  WRITE #B 'is an even number'
END-IF
*
F#TEXT(<'Hello', '*'>) /* Function used as a statement.
*
WRITE F#TEXT(<<(IR=A12) 'Good'>) /* Function with intermediate result.
*
END

```

The function F#ADDITION is defined in the sample function FUNCEX02 in library SYSEXP.G.

```

** Example 'FUNCEX02': Function call (Function)
*****
DEFINE FUNCTION F#ADDITION
  RETURNS (I2)
  DEFINE DATA PARAMETER
    1 #PARM1 (I2) OPTIONAL
    1 #PARM2 (I2) OPTIONAL
    1 #PARM3 (I2) OPTIONAL
  END-DEFINE
  /*
  RESET F#ADDITION
  IF #PARM1 SPECIFIED
    F#ADDITION := F#ADDITION + #PARM1

  END-IF
  IF #PARM2 SPECIFIED
    F#ADDITION := F#ADDITION + #PARM2

  END-IF
  IF #PARM3 SPECIFIED
    F#ADDITION := F#ADDITION + #PARM3

  END-IF
  /*
END-FUNCTION
*
END ↵

```

The function F#CHAR is defined in the example function FUNCEX03 in library SYSEXP.G.

```

** Example 'FUNCEX03': Function call (Function)
*****
DEFINE FUNCTION F#CHAR
  RETURNS (A1/1:2)
  /*
  F#CHAR(1) := 'A'
  F#CHAR(2) := 'B'
  /*
END-FUNCTION
*
END ↵

```

The function F#EVEN is defined in the example function FUNCEX04 in library SYSEXP.G.

```

** Example 'FUNCEX04': Function call (Function)
*****
DEFINE FUNCTION F#EVEN
  RETURNS (L)
  DEFINE DATA
  PARAMETER
    1 #NUM (N4) BY VALUE
  LOCAL
    1 #REST (I2)
  END-DEFINE
  /*
  DIVIDE 2 INTO #NUM REMAINDER #REST
  /*
  IF #REST = 0
    F#EVEN := TRUE
  ELSE
    F#EVEN := FALSE
  END-IF
  /*
END-FUNCTION
*
END ↵

```

The function F#TEXT is defined in the sample function FUNCEX05 in library SYSEXPB.

```

** Example 'FUNCEX05': Function call (Function)
*****
DEFINE FUNCTION F#TEXT
  RETURNS (A20) BY VALUE
  DEFINE DATA
  PARAMETER
    1 #TEXT1 (A5) BY VALUE
    1 #TEXT2 (A1) BY VALUE OPTIONAL
  LOCAL
    1 #FRAME (A3)
  END-DEFINE
  /*
  IF #TEXT2 SPECIFIED
    MOVE ALL #TEXT2 TO #FRAME
    /*
    COMPRESS #FRAME #TEXT1 'world' #FRAME INTO F#TEXT
    /*
    WRITE F#TEXT
  ELSE
    COMPRESS #TEXT1 'morning' INTO F#TEXT
    /*
  END-IF
  /*
END-FUNCTION
*
END ↵

```

**Output of Program** FUNCEX01

```
Sum of #B,#C      5
Character A found
    2 is an even number
*** Hello world ***
Good morning
```





# 15 Introduction to Dynamic Variables and Fields

---

- Purpose of Dynamic Variables ..... 116
- Definition of Dynamic Variables ..... 116
- Value Space Currently Used for a Dynamic Variable ..... 117
- Size Limitation Check ..... 117
- Allocating/Freeing Memory Space for a Dynamic Variable ..... 118

## Purpose of Dynamic Variables

---

In that the maximum size of large data structures (for example, pictures, sounds, videos) may not exactly be known at application development time, Natural additionally provides for the definition of alphanumeric and binary variables with the attribute `DYNAMIC`. The value space of variables which are defined with this attribute will be extended dynamically at execution time when it becomes necessary (for example, during an assignment operation: `#picture1 := #picture2`). This means that large binary and alphanumeric data structures may be processed in Natural without the need to define a limit at development time. The execution-time allocation of dynamic variables is of course subject to available memory restrictions. If the allocation of dynamic variables results in an insufficient memory condition being returned by the underlying operating system, the `ON ERROR` statement can be used to intercept this error condition; otherwise, an error message will be returned by Natural.

The Natural system variable `*LENGTH` can be used obtain the length (in terms of code units) of the value space which is currently used for a given dynamic variable. For `A` and `B` formats, the size of one code unit is 1 byte. For `U` format, the size of one code unit is 2 bytes (UTF-16). Natural automatically sets `*LENGTH` to the length of the source operand during assignments in which the dynamic variable is involved. `*LENGTH(field)` therefore returns the length (in terms of code units) currently used for a dynamic Natural field or variable.

If the dynamic variable space is no longer needed, the `REDUCE` or `RESIZE` statements can be used to reduce the space used for the dynamic variable to zero (or any other desired size). If the upper limit of memory usage is known for a specific dynamic variable, the `EXPAND` statement can be used to set the space used for the dynamic variable to this specific size.

If a dynamic variable is to be initialized, the `MOVE ALL UNTIL` statement should be used for this purpose.

## Definition of Dynamic Variables

---

Because the actual size of large alphanumeric and binary data structures may not be exactly known at application development time, the definition of *dynamic* variables of format `A`, `B` or `U` can be used to manage these structures. The dynamic allocation and extension (reallocation) of large variables is transparent to the application programming logic. Dynamic variables are defined without any length. Memory will be allocated either implicitly at execution time, when the dynamic variable is used as a target operand, or explicitly with an `EXPAND` or `RESIZE` statement.

Dynamic variables can only be defined in a `DEFINE DATA` statement using the following syntax:

```
level variable-name ( A ) DYNAMIC
level variable-name ( B ) DYNAMIC
level variable-name ( U ) DYNAMIC
```

**Restrictions:**

The following restrictions apply to a dynamic variable:

- A redefinition of a dynamic variable is not allowed.
- A dynamic variable may not be contained in a `REDEFINE` clause.

## Value Space Currently Used for a Dynamic Variable

---

The length (in terms of code units) of the currently used value space of a dynamic variable can be obtained from the system variable `*LENGTH`. `*LENGTH` is set to the (used) length of the source operand during assignments automatically.

 **Caution:** Due to performance considerations, the storage area that is allocated to hold the value of the dynamic variable may be larger than the value of `*LENGTH` (used size available to the programmer). You should not rely on the storage that is allocated beyond the used length as indicated by `*LENGTH`: it may be released at any time, even if the respective dynamic variable is not accessed. It is not possible for the Natural programmer to obtain information about the currently allocated size. This is an internal value.

`*LENGTH(field)` returns the used length (in terms of code units) of a dynamic Natural field or variable. For A and B formats, the size of one code unit is 1 byte. For U format, the size of one code unit is 2 bytes (UTF-16). `*LENGTH` may be used only to get the currently used length for dynamic variables.

## Size Limitation Check

---

**Profile Parameter USIZE**

For dynamic variables, a size limitation check at compile time is not possible because no length is defined for dynamic variables. The size of user buffer area (`USIZE`) indicates the size of the user buffer in virtual memory. The user buffer contains all data dynamically allocated by Natural. If a dynamic variable is allocated or extended at execution time and the `USIZE` limitation is exceeded, an error message will be returned.

## Allocating/Freeing Memory Space for a Dynamic Variable

---

The statements `EXPAND`, `REDUCE` and `RESIZE` are used to explicitly allocate and free memory space for a dynamic variable.

### Syntax:

```
EXPAND [SIZE OF] DYNAMIC [VARIABLE] operand1 TO operand2
REDUCE [SIZE OF] DYNAMIC [VARIABLE] operand1 TO operand2
RESIZE [SIZE OF] DYNAMIC [VARIABLE] operand1 TO operand2
```

- where *operand1* is a dynamic variable and *operand2* is a non-negative numeric size value.

### EXPAND

#### Function

The `EXPAND` statement is used to increase the allocated length of the dynamic variable (*operand1*) to the specified length (*operand2*).

#### Changing the Specified Size

The length currently used (as indicated by the Natural system variable `*LENGTH`, see [above](#)) for the dynamic variable is not modified.

If the specified length (*operand2*) is less than the allocated length of the dynamic variable, the statement will be ignored.

### REDUCE

#### Function

The `REDUCE` statement is used to reduce the allocated length of the dynamic variable (*operand1*) to the specified length (*operand2*).

The storage allocated for the dynamic variable (*operand1*) beyond the specified length (*operand2*) may be released at any time, when the statement is executed or at a later time.

#### Changing the Specified Length

If the length currently used (as indicated by the Natural system variable `*LENGTH`, see [above](#)) for the dynamic variable is greater than the specified length (*operand2*), the system variable `*LENGTH` of this dynamic variable is set to the specified length. The content of the variable is truncated, but not modified.

If the given length is larger than the currently allocated storage of the dynamic variable, the statement will be ignored.

## RESIZE

### Function

The `RESIZE` statement adjusts the currently allocated length of the dynamic variable (*operand1*) to the specified length (*operand2*).

### Changing the Specified Length

If the specified length is smaller than the used length (as indicated by the Natural system variable `*LENGTH`, see [above](#)) of the dynamic variable, the used length is reduced accordingly.

If the specified length is larger than the currently allocated length of the dynamic variable, the allocated length of the dynamic variable is increased. The currently used length (as indicated by the system variable `*LENGTH`) of the dynamic variable is not affected and remains unchanged.

If the specified length is the same as the currently allocated length of the dynamic variable, the execution of the `RESIZE` statement has no effect.



# 16 Using Dynamic and Large Variables

---

▪ General Remarks .....	122
▪ Assignments with Dynamic Variables .....	123
▪ Initialization of Dynamic Variables .....	125
▪ String Manipulation with Dynamic Alphanumeric Variables .....	125
▪ Logical Condition Criterion (LCC) with Dynamic Variables .....	126
▪ AT/IF-BREAK of Dynamic Control Fields .....	128
▪ Parameter Transfer with Dynamic Variables .....	128
▪ Work File Access with Large and Dynamic Variables .....	131
▪ DDM Generation and Editing for Varying Length Columns .....	132
▪ Accessing Large Database Objects .....	134
▪ Performance Aspects with Dynamic Variables .....	135
▪ Outputting Dynamic Variables .....	136
▪ Dynamic X-Arrays .....	137

## General Remarks

Generally, the following rules apply:

- A dynamic alphanumeric field may be used wherever an alphanumeric field is allowed.
- A dynamic binary field may be used wherever a binary field is allowed.
- A dynamic Unicode field may be used wherever a Unicode field is allowed.

### Exception:

Dynamic variables are not allowed within the `SORT` statement. To use dynamic variables in a `DISPLAY`, `WRITE`, `PRINT`, `REINPUT` or `INPUT` statement, you must use either the session parameter `AL` or `EM` to define the length of the variable.

The used length (as indicated by the Natural system variable `*LENGTH`, see [Value Space Currently Used for a Dynamic Variable](#)) and the size of the allocated storage of dynamic variables are equal to zero until the variable is accessed as a target operand for the first time. Due to assignments or other manipulation operations, dynamic variables may be firstly allocated or extended (reallocated) to the exact size of the source operand.

The size of a dynamic variable may be extended if it is used as a modifiable operand (target operand) in the following statements:

ASSIGN	<i>operand1</i> (destination operand in an assignment).
CALLNAT	See <i>Parameter Transfer with Dynamic Variables</i> (except if <code>AD=0</code> , or if <code>BY VALUE</code> exists in the corresponding parameter data area).
COMPRESS	<i>operand2</i> , see <i>Processing</i> .
EXAMINE	<i>operand1</i> in the <code>DELETE REPLACE</code> clause.
MOVE	<i>operand2</i> (destination operand), see <i>Function</i> .
PERFORM	(except if <code>AD=0</code> , or if <code>BY VALUE</code> exists in the corresponding parameter data area).
READ WORK FILE	<i>operand1</i> and <i>operand2</i> , see <i>Handling of Large and Dynamic Variables</i> .
SEPARATE	<i>operand4</i> .
SELECT (SQL)	<i>parameter</i> in the <code>INTO</code> Clause.
SEND METHOD	<i>operand3</i> (except if <code>AD=0</code> ).

Currently, there is the following limit concerning the usage of large variables:



CALL	Parameter size less than 64 KB per parameter (no limit for CALL with INTERFACE4 option).
------	--

In the following sections, the use of dynamic variables is discussed in more detail on the basis of examples.

## Assignments with Dynamic Variables

Generally, an assignment is done in the current used length (as indicated by the Natural system variable `*LENGTH`) of the source operand. If the destination operand is a dynamic variable, its current allocated size is possibly extended in order to move the source operand without truncation.

Example:

```
#MYDYNTXT1 := OPERAND
MOVE OPERAND TO #MYDYNTXT1
/* #MYDYNTXT1 IS AUTOMATICALLY EXTENDED UNTIL THE SOURCE OPERAND CAN BE COPIED ↵
```

`MOVE ALL`, `MOVE ALL UNTIL` with dynamic target operands are defined as follows:

- `MOVE ALL` moves the source operand repeatedly to the target operand until the used length (`*LENGTH`) of the target operand is reached. The system variable `*LENGTH` is not modified. If `*LENGTH` is zero, the statement will be ignored.
- `MOVE ALL operand1 TO operand2 UNTIL operand3` moves *operand1* repeatedly to *operand2* until the length specified in *operand3* is reached. If *operand3* is greater than `*LENGTH(operand2)`, *operand2* is extended and `*LENGTH(operand2)` is set to *operand3*. If *operand3* is less than `*LENGTH(operand2)`, the used length is reduced to *operand3*. If *operand3* equals `*LENGTH(operand2)`, the behavior is equivalent to `MOVE ALL`.

Example:

```
#MYDYNTXT1 := 'ABCDEFGHIJKLMNO'          /* *LENGTH(#MYDYNTXT1) = 15
MOVE ALL 'AB' TO #MYDYNTXT1              /* CONTENT OF #MYDYNTXT1 = ↵
'ABABABABABABABA';                      /* *LENGTH IS STILL 15
MOVE ALL 'CD' TO #MYDYNTXT1 UNTIL 6      /* CONTENT OF #MYDYNTXT1 = 'CDCDCD';
                                           /* *LENGTH = 6
MOVE ALL 'EF' TO #MYDYNTXT1 UNTIL 10     /* CONTENT OF #MYDYNTXT1 = 'EFEFEFEFEF';
                                           /* *LENGTH = 10
```

`MOVE JUSTIFIED` is rejected at compile time if the target operand is a dynamic variable.

`MOVE SUBSTR` and `MOVE TO SUBSTR` are allowed. `MOVE SUBSTR` will lead to a runtime error if a sub-string behind the used length of a dynamic variable (`*LENGTH`) is referenced. `MOVE TO SUBSTR` will lead to a runtime error if a sub-string position behind `*LENGTH + 1` is referenced, because this would lead to an undefined gap in the content of the dynamic variable. If the target operand

should be extended by MOVE TO SUBSTR (for example if the second operand is set to \*LENGTH+1), the third operand is mandatory.

Valid syntax:

```
#OP2 := *LENGTH(#MYDYNTTEXT1)
MOVE SUBSTR (#MYDYNTTEXT1, #OP2) TO OPERAND          /* MOVE LAST CHARACTER ↵
TO OPERAND
#OP2 := *LENGTH(#MYDYNTTEXT1) + 1
MOVE OPERAND TO SUBSTR(#MYDYNTTEXT1, #OP2, #LEN_OPERAND) /* CONCATENATE OPERAND ↵
TO #MYDYNTTEXT1          ↵
```

Invalid syntax:

```
#OP2 := *LENGTH(#MYDYNTTEXT1) + 1
MOVE SUBSTR (#MYDYNTTEXT1, #OP2, 10) TO OPERAND      /* LEADS TO RUNTIME ERROR; ↵
UNDEFINED SUB-STRING
#OP2 := *LENGTH(#MYDYNTTEXT1 + 10)
MOVE OPERAND TO SUBSTR(#MYDYNTTEXT1, #OP2, #EN_OPERAND) /* LEADS TO RUNTIME ERROR; ↵
UNDEFINED GAP
#OP2 := *LENGTH(#MYDYNTTEXT1) + 1
MOVE OPERAND TO SUBSTR(#MYDYNTTEXT1, #OP2)          /* LEADS TO RUNTIME ERROR; ↵
UNDEFINED LENGTH
```

### Assignment Compatibility

Example:

```
#MYDYNTTEXT1 := #MYSTATICVAR1
#MYSTATICVAR1 := #MYDYNTTEXT2 ↵
```

If the source operand is a static variable, the used length of the dynamic destination operand (\*LENGTH(#MYDYNTTEXT1)) is set to the format length of the static variable and the source value is copied in this length including trailing blanks (alphanumeric and Unicode fields) or binary zeros (for binary fields).

If the destination operand is static and the source operand is dynamic, the dynamic variable is copied in its currently used length. If this length is less than the format length of the static variable, the remainder is filled with blanks (for alphanumeric and Unicode fields) or binary zeros (for binary fields). Otherwise, the value will be truncated. If the currently used length of the dynamic variable is 0, the static target operand is filled with blanks (for alphanumeric and Unicode fields) or binary zeros (for binary fields).

## Initialization of Dynamic Variables

Dynamic variables can be initialized with blanks (alphanumeric and Unicode fields) or zeros (binary fields) up to the currently used length (= \*LENGTH) using the RESET statement. The system variable \*LENGTH is not modified.

Example:

```
DEFINE DATA LOCAL
1 #MYDYNTXT1 (A) DYNAMIC
END-DEFINE
#MYDYNTXT1 := 'SHORT TEXT'
WRITE *LENGTH(#MYDYNTXT1) /* USED LENGTH = 10
RESET #MYDYNTXT1 /* USED LENGTH = 10, VALUE = 10 BLANKS ↵
```

To initialize a dynamic variable with a specified value in a specified size, the MOVE ALL UNTIL statement may be used.

Example:

```
MOVE ALL 'Y' TO #MYDYNTXT1 UNTIL 15 /* #MYDYNTXT1 CONTAINS 15 'Y'S, USED ↵
LENGTH = 15 ↵
```

## String Manipulation with Dynamic Alphanumeric Variables

If a modifiable operand is a dynamic variable, its current allocated size is possibly extended in order to perform the operation without truncation or an error message. This is valid for the concatenation (COMPRESS) and separation of dynamic alphanumeric variables (SEPARATE).

Example:

```
** Example 'DYNAMX01': Dynamic variables (with COMPRESS and SEPARATE)
*****
DEFINE DATA LOCAL
1 #MYDYNTXT1 (A) DYNAMIC
1 #TEXT (A20)
1 #DYN1 (A) DYNAMIC
1 #DYN2 (A) DYNAMIC
1 #DYN3 (A) DYNAMIC
END-DEFINE
*
MOVE ' HELLO WORLD ' TO #MYDYNTXT1
WRITE #MYDYNTXT1 (AL=25) 'with length' *LENGTH (#MYDYNTXT1)
/* dynamic variable with leading and trailing blanks
*
```

```
MOVE ' HELLO WORLD ' TO #TEXT
*
MOVE #TEXT TO #MYDYNTXT1
WRITE #MYDYNTXT1 (AL=25) 'with length' *LENGTH (#MYDYNTXT1)
/* dynamic variable with whole variable length of #TEXT
*
COMPRESS #TEXT INTO #MYDYNTXT1
WRITE #MYDYNTXT1 (AL=25) 'with length' *LENGTH (#MYDYNTXT1)
/* dynamic variable with leading blanks of #TEXT
*
*
#MYDYNTXT1 := 'HERE COMES THE SUN'
SEPARATE #MYDYNTXT1 INTO #DYN1 #DYN2 #DYN3 IGNORE
*
WRITE / #MYDYNTXT1 (AL=25) 'with length' *LENGTH (#MYDYNTXT1)
WRITE #DYN1 (AL=25) 'with length' *LENGTH (#DYN1)
WRITE #DYN2 (AL=25) 'with length' *LENGTH (#DYN2)
WRITE #DYN3 (AL=25) 'with length' *LENGTH (#DYN3)
/* #DYN1, #DYN2, #DYN3 are automatically extended or reduced
*
EXAMINE #MYDYNTXT1 FOR 'SUN' REPLACE 'MOON'
WRITE / #MYDYNTXT1 (AL=25) 'with length' *LENGTH (#MYDYNTXT1)
/* #MYDYNTXT1 is automatically extended or reduced
*
END
```



**Note:** In case of non-dynamic variables, an error message may be returned.

## Logical Condition Criterion (LCC) with Dynamic Variables

---

Generally, a read-only operation (such as a comparison) with a dynamic variable is done with its currently used length. Dynamic variables are processed like static variables if they are used in a read-only (non-modifiable) context.

Example:

```
IF #MYDYNTXT1 = #MYDYNTXT2 OR #MYDYNTXT1 = "***" THEN ...
IF #MYDYNTXT1 < #MYDYNTXT2 OR #MYDYNTXT1 < "***" THEN ...
IF #MYDYNTXT1 > #MYDYNTXT2 OR #MYDYNTXT1 > "***" THEN ...
```

Trailing blanks for alphanumeric and Unicode variables or leading binary zeros for binary variables are processed in the same way for static and dynamic variables. For example, alphanumeric variables containing the values AA and AA followed by a blank will be considered being equal, and binary variables containing the values H'0000031' and H'3031' will be considered being equal. If a comparison result should only be TRUE in case of an exact copy, the used lengths of the dynamic variables have to be compared in addition. If one variable is an exact copy of the other, their used lengths are also equal.

**Example:**

```
#MYDYNTTEXT1 := 'HELLO' /* USED LENGTH IS 5
#MYDYNTTEXT2 := 'HELLO ' /* USED LENGTH IS 10
IF #MYDYNTTEXT1 = #MYDYNTTEXT2 THEN ... /* TRUE
IF #MYDYNTTEXT1 = #MYDYNTTEXT2 AND
   *LENGTH(#MYDYNTTEXT1) = *LENGTH(#MYDYNTTEXT2) THEN ... /* FALSE
```

Two dynamic variables are compared position by position (from left to right for alphanumeric variables, and right to left for binary variables) up to the minimum of their used lengths. The first position where the variables are not equal determines if the first or the second variable is greater than, less than or equal to the other. The variables are equal if they are equal up to the minimum of their used lengths and the remainder of the longer variable contains only blanks for alphanumeric dynamic variables or binary zeros for binary dynamic variables. To compare two Unicode dynamic variables, trailing blanks are removed from both values before the ICU collation algorithm is used to compare the two resulting values. See also *Logical Condition Criteria* in the *Unicode and Code Page Support* documentation.

**Example:**

```
#MYDYNTTEXT1 := 'HELLO1' /* USED LENGTH IS 6
#MYDYNTTEXT2 := 'HELLO2' /* USED LENGTH IS 10
IF #MYDYNTTEXT1 < #MYDYNTTEXT2 THEN ... /* TRUE
#MYDYNTTEXT2 := 'HALLO'
IF #MYDYNTTEXT1 > #MYDYNTTEXT2 THEN ... /* TRUE
```

**Comparison Compatibility**

Comparisons between dynamic and static variables are equivalent to comparisons between dynamic variables. The format length of the static variable is interpreted as its used length.

**Example:**

```
#MYSTATTEXT1 := 'HELLO' /* FORMAT LENGTH OF MYSTATTEXT1 IS ←
A20
#MYDYNTTEXT1 := 'HELLO' /* USED LENGTH IS 5
IF #MYSTATTEXT1 = #MYDYNTTEXT1 THEN ... /* TRUE
IF #MYSTATTEXT1 > #MYDYNTTEXT1 THEN ... /* FALSE
```

## AT/IF-BREAK of Dynamic Control Fields

---

The comparison of the break control field with its old value is performed position by position from left to right. If the old and the new value of the dynamic variable are of different length, then for comparison, the value with shorter length is padded to the right (with blanks for alphanumeric and Unicode dynamic values or binary zeros for binary values).

In case of an alphanumeric or Unicode break control field, trailing blanks are not significant for the comparison, that is, trailing blanks do not mean a change of the value and no break occurs.

In case of a binary break control field, trailing binary zeros are not significant for the comparison, that is, trailing binary zeros do not mean a change of the value and no break occurs.

## Parameter Transfer with Dynamic Variables

---

Dynamic variables may be passed as parameters to a called program object (`CALLNAT`, `PERFORM`). A call-by-reference is possible because the value space of a dynamic variable is contiguous. A call-by-value causes an assignment with the variable definition of the caller as the source operand and the parameter definition as the destination operand. A call-by-value result causes in addition the movement in the opposite direction.

For a call-by-reference, both definitions must be `DYNAMIC`. If only one of them is `DYNAMIC`, a runtime error is raised. In the case of a call-by-value (result), all combinations are possible. The following table illustrates the valid combinations:

### Call By Reference

Caller	Parameter	
	Static	Dynamic
Static	Yes	No
Dynamic	No	Yes

The formats of dynamic variables A or B must match.

**Call by Value (Result)**

Caller	Parameter	
	Static	Dynamic
Static	Yes	Yes
Dynamic	Yes	Yes



**Note:** In the case of static/dynamic or dynamic/static definitions, a value truncation may occur according to the data transfer rules of the appropriate assignments.

**Example 1:**

```

** Example 'DYNAMX02': Dynamic variables (as parameters)
*****
DEFINE DATA LOCAL
1 #MYTEXT (A) DYNAMIC
END-DEFINE
*
#MYTEXT := '123456'      /* extended to 6 bytes, *LENGTH(#MYTEXT) = 6
*
CALLNAT 'DYNAMX03' USING #MYTEXT
*
WRITE *LENGTH(#MYTEXT)      /* *LENGTH(#MYTEXT) = 8
*
END

```

**Subprogram DYNAMX03:**

```

** Example 'DYNAMX03': Dynamic variables (as parameters)
*****
DEFINE DATA PARAMETER
1 #MYPARM (A) DYNAMIC BY VALUE RESULT
END-DEFINE
*
WRITE *LENGTH(#MYPARM)      /* *LENGTH(#MYPARM) = 6
#MYPARM := '1234567'        /* *LENGTH(#MYPARM) = 7
#MYPARM := '12345678'      /* *LENGTH(#MYPARM) = 8
EXPAND DYNAMIC VARIABLE #MYPARM TO 10 /* 10 bytes are allocated
*
WRITE *LENGTH(#MYPARM)      /* *LENGTH(#MYPARM) = 8
*
/* content of #MYPARM is moved back to #MYTEXT
/* used length of #MYTEXT = 8
*
END

```

**Example 2:**

```

** Example 'DYNAMX04': Dynamic variables (as parameters)
*****
DEFINE DATA LOCAL
1 #MYTEXT (A) DYNAMIC
END-DEFINE
*
#MYTEXT := '123456'      /* extended to 6 bytes, *LENGTH(#MYTEXT) = 6
*
CALLNAT 'DYNAMX05' USING #MYTEXT
*
WRITE *LENGTH(#MYTEXT)      /* *LENGTH(#MYTEXT) = 8
                             /* at least 10 bytes are
                             /* allocated (extended in DYNAMX05)
*
END

```

**Subprogram DYNAMX05:**

```

** Example 'DYNAMX05': Dynamic variables (as parameters)
*****
DEFINE DATA PARAMETER
1 #MYPARM (A) DYNAMIC
END-DEFINE
*
WRITE *LENGTH(#MYPARM)      /* *LENGTH(#MYPARM) = 6
#MYPARM := '1234567'        /* *LENGTH(#MYPARM) = 7
#MYPARM := '12345678'       /* *LENGTH(#MYPARM) = 8
EXPAND DYNAMIC VARIABLE #MYPARM TO 10 /* 10 bytes are allocated
*
WRITE *LENGTH(#MYPARM)      /* *LENGTH(#MYPARM) = 8
*
END

```

**CALL 3GL Program**

Dynamic and large variables can sensibly be used with the `CALL` statement when the option `INTERFACE4` is used. Using this option leads to an interface to the 3GL program with a different parameter structure.

This usage requires some minor changes in the 3GL program, but provides the following significant benefits as compared with the older `FINFO` structure.

- No limitation on the number of passed parameters (former limit 40).
- No limitation on the parameter's data size (former limit 64 KB per parameter).



- Full parameter information can be passed to the 3GL program including array information. Exported functions are provided which allow secure access to the parameter data (formerly you had to take care not to overwrite memory inside of Natural)

For further information on the `FINFO` structure, see the `CALL INTERFACE4` statement.

Before calling a 3GL program with dynamic parameters, it is important to ensure that the necessary buffer size is allocated. This can be done explicitly with the `EXPAND` statement.

If an initialized buffer is required, the dynamic variable can be set to the initial value and to the necessary size by using the `MOVE ALL UNTIL` statement. Natural provides a set of functions that allow the 3GL program to obtain information about the dynamic parameter and to modify the length when parameter data is passed back.

Example:

```
MOVE ALL ' ' TO #MYDYNTXT1 UNTIL 10000
/* a buffer of length 10000 is allocated
/* #MYDYNTXT1 is initialized with blanks
/* and *LENGTH(#MYDYNTXT1) = 10000
CALL INTERFACE4 'MYPROG' USING #MYDYNTXT1
WRITE *LENGTH(#MYDYNTXT1)
/* *LENGTH(#MYDYNTXT1) may have changed in the 3GL program
```

For a more detailed description, refer to the `CALL` statement in the *Statements* documentation.

## Work File Access with Large and Dynamic Variables

The following topics are covered below:

- [PORTABLE and UNFORMATTED](#)
- [ASCII, ASCII-COMPRESSED and SAG](#)
- [Special Conditions for TRANSFER and ENTIRE CONNECTION](#)

### PORTABLE and UNFORMATTED

Large and dynamic variables can be written into work files or read from work files using the two work file types `PORTABLE` and `UNFORMATTED`. For these types, there is no size restriction for dynamic variables. However, large variables may not exceed a maximum field/record length of 32766 bytes.

For the work file type `PORTABLE`, the field information is stored within the work file. The dynamic variables are resized during `READ` if the field size in the record is different from the current size.

The work file type `UNFORMATTED` can be used, for example, to read a video from a database and store it in a file directly playable by other utilities. In the `WRITE WORK` statement, the fields are written to the file with their byte length. All data types (`DYNAMIC` or not) are treated the same. No

structural information is inserted. Note that Natural uses a buffering mechanism, so you can expect the data to be completely written only after a `CLOSE WORK`. This is especially important if the file is to be processed with another utility while Natural is running.

With the `READ WORK` statement, fields of fixed length are read with their whole length. If the end-of-file is reached, the remainder of the current field is filled with blanks. The following fields are unchanged. In the case of `DYNAMIC` data types, all the remainder of the file is read unless it exceeds 1073741824 bytes. If the end of file is reached, the remaining fields (variables) are kept unchanged (normal Natural behavior).

### **ASCII, ASCII-COMPRESSED and SAG**

The work file types `ASCII`, `ASCII-COMPRESSED` and `SAG` (binary) cannot handle dynamic variables and will produce an error. Large variables for these work file types pose no problem unless the maximum field/record length of 32766 bytes is exceeded.

### **Special Conditions for TRANSFER and ENTIRE CONNECTION**

In conjunction with the `READ WORK FILE` statement, the work file type `TRANSFER` can handle dynamic variables. There is no size limit for dynamic variables. The work file type `ENTIRE CONNECTION` cannot handle dynamic variables. They can both, however, handle large variables with a maximum field/record length of 1073741824 bytes.

In conjunction with the `WRITE WORK FILE` statement, the work file type `TRANSFER` can handle dynamic variables with a maximum field/record length of 32766 bytes. The work file type `ENTIRE CONNECTION` cannot handle dynamic variables. They can both, however, handle large variables with a maximum field/record length of 1073741824 bytes.

## **DDM Generation and Editing for Varying Length Columns**

---

Depending on the data types, the related database format A or format B is generated. For the databases' data type `VARCHAR` the Natural length of the column is set to the maximum length of the data type as defined in the DBMS. If a data type is very large, the keyword `DYNAMIC` is generated at the length field position.

For all varying length columns, an `LINDICATOR` field `L@<column-name>` will be generated. For the databases' data type `VARCHAR`, an `LINDICATOR` field with format/length `I2` will be generated. For large data types (see list below) the format/length will be `I4`.

In the context of database access, the `LINDICATOR` handling offers the chance to get the length of the field to be read or to set the length of the field to be written independent of a defined buffer length (or independent of `*LENGTH`). Usually, after a retrieval function, `*LENGTH` will be set to the corresponding length indicator value.

**Example DDM:**

```

T L Name          F  Leng      S  D  Remark
:
1 L@PICTURE1      I   4
length indicator
1 PICTURE1        B   DYNAMIC      IMAGE
1 N@PICTURE1      I   2          /* NULL ↵
indicator
1 L@TEXT1         I   4          /* ↵
length indicator
1 TEXT1           A   DYNAMIC      TEXT
1 N@TEXT1         I   2          /* NULL ↵
indicator
1 L@DESCRIPTION   I   2          /* ↵
length indicator
1 DESCRIPTION     A  1000          VARCHAR(1000)
:
:
~~~~~Extended Attributes~~~~~/* ↵
concerning PICTURE1
Header           :   ---
Edit Mask        :   ---
Remarks         :   IMAGE

```

The generated formats are varying length formats. The Natural programmer has the chance to change the definition from `DYNAMIC` to a fixed length definition (extended field editing) and can change, for example, the corresponding DDM field definition for `VARCHAR` data types to a multiple value field (old generation).

**Example:**

```

T L Name          F  Leng      S  D  Remark
:
1 L@PICTURE1      I   4
length indicator
1 PICTURE1        B 1000000000    IMAGE
1 N@PICTURE1      I   2          /* NULL ↵
indicator
1 L@TEXT1         I   4          /* ↵
length indicator
1 TEXT1           A   5000      TEXT
1 N@TEXT1         I   2          /* NULL ↵
indicator
1 L@DESCRIPTION   I   2          /* ↵
length indicator
M 1 DESCRIPTION   A   100          VARCHAR(1000)
:
:
~~~~~Extended Attributes~~~~~/* ↵
concerning PICTURE1

```

```
Header      :    ---
Edit Mask   :    ---
Remarks    :    IMAGE
```

## Accessing Large Database Objects

To access a database with large objects (CLOBs or BLOBs), a DDM with corresponding large alphanumeric, Unicode or binary fields is required. If a fixed length is defined and if the database large object does not fit into this field, the large object is truncated. If the programmer does not know the definitive length of the database object, it will make sense to work with dynamic fields. As many reallocations as necessary are done to hold the object. No truncation is performed.

### Example Program:

```
DEFINE DATA LOCAL

1 person VIEW OF xyz-person
  2 last_name
  2 first_name_1
  2 L@PICTURE1          /* I4 length indicator for PICTURE1
  2 PICTURE1           /* defined as dynamic in the DDM
  2 TEXT1              /* defined as non-dynamic in the DDM

END-DEFINE

SELECT * INTO VIEW person FROM xyz-person          /* PICTURE1 will be ←
read completely
                                WHERE last_name = 'SMITH' /* TEXT1 will be ←
truncated to fixed length 5000

  WRITE 'length of PICTURE1: ' L@PICTURE1          /* the L-INDICATOR will ←
contain the length
                                                /* of PICTURE1 (= ←
*LENGTH(PICTURE1)
  /* do something with PICTURE1 and TEXT1

  L@PICTURE1 := 100000
  INSERT INTO xyz-person (*) VALUES (VIEW person) /* only the first 100000 ←
Bytes of PICTURE1
                                                /* are inserted

END-SELECT ←
```

If a format-length definition is omitted in the view, this is taken from the DDM. In reporting mode, it is now possible to specify any length, if the corresponding DDM field is defined as `DYNAMIC`. The dynamic field will be mapped to a field with a fixed buffer length. The other way round is not possible.

DDM format/length definition	VIEW format / length definition	
(An)	-	valid
	(An)	valid
	(Am)	only valid in reporting mode
	(A) DYNAMIC	invalid
(A) DYNAMIC	-	valid
	(A) DYNAMIC	valid
	(An)	only valid in reporting mode
	(Am / i : j)	only valid in reporting mode

(equivalent for Format B variables)

### Parameter with LINDICATOR Clause in SQL Statements

If the `LINDICATOR` field is defined as an I2 field, the SQL data type `VARCHAR` is used for sending or receiving the corresponding column. If the `LINDICATOR` host variable is specified as I4, a large object data type (`CLOB/BLOB`) is used.

If the field is defined as `DYNAMIC`, the column is read in an internal loop up to its real length. The `LINDICATOR` field and the system variable `*LENGTH` are set to this length. In the case of a fixed-length field, the column is read up to the defined length. In both cases, the field is written up to the value defined in the `LINDICATOR` field.

## Performance Aspects with Dynamic Variables

If a dynamic variable is to be expanded in small quantities multiple times (for example, byte-wise), use the `EXPAND` statement before the iterations if the upper limit of required storage is (approximately) known. This avoids additional overhead to adjust the storage needed.

Use the `REDUCE` or `RESIZE` statement if the dynamic variable will no longer be needed, especially for variables with a high value of the system variable `*LENGTH`. This enables Natural you to release or reuse the storage. Thus, the overall performance may be improved.

The amount of the allocated memory of a dynamic variable may be reduced using the `REDUCE DYNAMIC VARIABLE` statement. In order to (re)allocate a variable to a specified length, the `EXPAND` statement can be used. (If the variable should be initialized, use the `MOVE ALL UNTIL` statement.)

**Example:**

```
** Example 'DYNAMX06': Dynamic variables (allocated memory)
*****
DEFINE DATA LOCAL
1 #MYDYNTXT1 (A) DYNAMIC
1 #LEN      (I4)
END-DEFINE
*
#MYDYNTXT1 := 'a'      /* used length is 1, value is 'a'
                      /* allocated size is still 1
WRITE *LENGTH(#MYDYNTXT1)
*
EXPAND DYNAMIC VARIABLE #MYDYNTXT1 TO 100
                      /* used length is still 1, value is 'a'
                      /* allocated size is 100
*
CALLNAT 'DYNAMX05' USING #MYDYNTXT1
WRITE *LENGTH(#MYDYNTXT1)
                      /* used length and allocated size
                      /* may have changed in the subprogram
*
#LEN := *LENGTH(#MYDYNTXT1)
REDUCE DYNAMIC VARIABLE #MYDYNTXT1 TO #LEN
                      /* if allocated size is greater than used length,
                      /* the unused memory is released
*
REDUCE DYNAMIC VARIABLE #MYDYNTXT1 TO 0
WRITE *LENGTH(#MYDYNTXT1)
                      /* free allocated memory for dynamic variable
END
```

**Rules:**

- Use dynamic operands where it makes sense.
- Use the `EXPAND` statement if upper limit of memory usage is known.
- Use the `REDUCE` statement if the dynamic operand will no longer be needed.

## Outputting Dynamic Variables

---

Dynamic variables may be used inside output statements such as the following:

Statement	Notes
DISPLAY	With these statements, you must set the format of the output or input of dynamic variables using the AL (Alphanumeric Length for Output) or EM (Edit Mask) session parameters.
WRITE	
INPUT	
REINPUT	--
PRINT	Because the output of the PRINT statement is unformatted, the output of dynamic variables in the PRINT statement need not be set using AL and EM parameters. In other words, these parameters may be omitted.

## Dynamic X-Arrays

A dynamic X-array may be allocated by first specifying the number of occurrences and then expanding the length of the previously allocated array occurrences.

Example:

```

DEFINE DATA LOCAL
1 #X-ARRAY(A/1:*) DYNAMIC
END-DEFINE
*
EXPAND ARRAY #X-ARRAY TO (1:10) /* Current boundaries (1:10)
#X-ARRAY(*) := 'ABC'
EXPAND ARRAY #X-ARRAY TO (1:20) /* Current boundaries (1:20)
#X-ARRAY(11:20) := 'DEF'

```





# 17

## User-Defined Constants

---

▪ Numeric Constants .....	140
▪ Alphanumeric Constants .....	141
▪ Unicode Constants .....	142
▪ Date and Time Constants .....	145
▪ Hexadecimal Constants .....	146
▪ Logical Constants .....	148
▪ Floating Point Constants .....	148
▪ Attribute Constants .....	149
▪ Handle Constants .....	150
▪ Defining Named Constants .....	150

Constants can be used throughout Natural programs. This document discusses the types of constants that are supported and how they are used.

## Numeric Constants

The following topics are covered below:

- [Numeric Constants](#)
- [Validation of Numeric Constants](#)

### Numeric Constants

A numeric constant may contain 1 to 29 numeric digits, a special character as decimal separator (period or comma) and a sign.

Examples:

```
1234   +1234   -1234
12.34  +12.34  -12.34
```

```
MOVE 3 TO #XYZ
COMPUTE #PRICE = 23.34
COMPUTE #XYZ = -103
COMPUTE #A = #B * 6074
```



**Note:** Internally, numeric constants without decimal digits are represented in integer form (format I), while numeric constants with decimal digits, as well as numeric constants without decimal digits that are too large to fit into format I, are represented in packed form (format P).

Example:

Numeric Constant		Format	Length
From	To		
	<= -2147483649	P	>=10
-2147483648	-32769	I	4
-32768	32767	I	2
32768	2147483647	I	4
>= 2147483648		P	>=10

## Validation of Numeric Constants

When numeric constants are used within one of the statements `COMPUTE`, `MOVE`, or `DEFINE DATA` with `INIT` option, Natural checks at compilation time whether a constant value fits into the corresponding field. This avoids runtime errors in situations where such an error condition can already be detected during compilation.

## Alphanumeric Constants

The following topics are covered below:

- [Alphanumeric Constants](#)
- [Apostrophes Within Alphanumeric Constants](#)
- [Concatenation of Alphanumeric Constants](#)

### Alphanumeric Constants

An alphanumeric constant may contain 1 to 1 073 741 824 bytes (1 GB) of alphanumeric characters.

An alphanumeric constant must be enclosed in either apostrophes (')

```
'text'
```

or quotation marks (")

```
"text"
```

Examples:

```
MOVE 'ABC' TO #FIELDX  
MOVE '% INCREASE' TO #TITLE  
DISPLAY "LAST-NAME" NAME
```



**Note:** An alphanumeric constant that is used to assign a value to a **user-defined variable** must not be split between statement lines.

## Apostrophes Within Alphanumeric Constants

If you want an apostrophe to be part of an alphanumeric constant that is enclosed in apostrophes, you must write this as two apostrophes or as a single quotation mark.

If you want an apostrophe to be part of an alphanumeric constant that is enclosed in quotation marks, you write this as a single apostrophe.

Example:

If you want the following to be output:

```
HE SAID, 'HELLO'
```

you can use any of the following notations:

```
WRITE 'HE SAID, ''HELLO'''  
WRITE 'HE SAID, "HELLO"'  
WRITE "HE SAID, ""HELLO"""  
WRITE "HE SAID, 'HELLO'"
```



**Note:** If quotation marks are not converted to apostrophes as shown above, this is due to the setting of profile parameter `TQMARK` (Translate Quotation Marks); ask your Natural administrator for details.

## Concatenation of Alphanumeric Constants

Alphanumeric constants may be concatenated to form a single value by use of a hyphen.

Examples:

```
MOVE 'XXXXXX' - 'YYYYYY' TO #FIELD  
MOVE "ABC" - 'DEF' TO #FIELD
```

In this way, alphanumeric constants can also be concatenated with [hexadecimal constants](#).

## Unicode Constants

---

The following topics are covered below:

- [Unicode Text Constants](#)
- [Apostrophes Within Unicode Text Constants](#)
- [Unicode Hexadecimal Constants](#)

- Concatenation of Unicode Constants

### Unicode Text Constants

A Unicode text constant must be preceded by the character `U` and enclosed in either apostrophes (`'`)

```
U'text'
```

or quotation marks (`"`)

```
U"text"
```

Example:

```
U'HELLO'
```

The compiler stores this text constant in the generated program in Unicode format (UTF-16).

### Apostrophes Within Unicode Text Constants

If you want an apostrophe to be part of a Unicode text constant that is enclosed in apostrophes, you must write this as two apostrophes or as a single quotation mark.

If you want an apostrophe to be part of a Unicode text constant that is enclosed in quotation marks, you write this as a single apostrophe.

Example:

If you want the following to be output:

```
HE SAID, 'HELLO'
```

you can use any of the following notations:

```
WRITE U'HE SAID, ''HELLO''
WRITE U'HE SAID, "HELLO"
WRITE U"HE SAID, ""HELLO""
WRITE U"HE SAID, 'HELLO'"
```



**Note:** If quotation marks are not converted to apostrophes as shown above, this is due to the setting of the profile parameter `TQ` (Translate Quotation Marks); ask your Natural administrator for details.

## Unicode Hexadecimal Constants

The following syntax is used to supply a Unicode character or a Unicode string by its hexadecimal notation:

```
UH' hhhh...'
```

where *h* represents a hexadecimal digit (0-9, A-F). Since a UTF-16 Unicode character consists of a double-byte, the number of hexadecimal characters supplied has to be a multiple of four.

Example:

This example defines the string 45.

```
UH'00340035'
```

## Concatenation of Unicode Constants

Concatenation of Unicode text constants (U) and Unicode hexadecimal constants (UH) is allowed.

Valid Example:

```
MOVE U'XXXXXX' - UH'00340035' TO #FIELD
```

Unicode text constants or Unicode hexadecimal constants cannot be concatenated with code page alphanumeric constants or H constants.

Invalid Example:

```
MOVE U'ABC' - 'DEF' TO #FIELD
MOVE UH'00340035' - H'414243' TO #FIELD
```

Further Valid Example:

```
DEFINE DATA LOCAL
1 #U10 (U10)          /* Unicode variable with 10 (UTF-16) characters, total ↵
byte length = 20
1 #UD (U) DYNAMIC    /* Unicode variable with dynamic length
END-DEFINE
*
#U10 := U'ABC'        /* Constant is created as X'004100420043' in the object, ↵
the UTF-16 representation for string 'ABC'.

#U10 := UH'004100420043' /* Constant supplied in hexadecimal format only, ↵
corresponds to U'ABC'

#U10 := U'A'-UH'0042'-U'C' /* Constant supplied in mixed formats, corresponds to ↵
U'ABC'.
END
```

## Date and Time Constants

The following topics are covered below:

- [Date Constant](#)
- [Time Constant](#)
- [Extended Time Constant](#)

### Date Constant

A date constant may be used in conjunction with a format D variable.

Date constants may have the following formats:

D' <i>yyyy-mm-dd</i> '	International date format
D' <i>dd.mm.yyyy</i> '	German date format
D' <i>dd/mm/yyyy</i> '	European date format
D' <i>mm/dd/yyyy</i> '	US date format

where *dd* represents the number of the day, *mm* the number of the month and *yyyy* the year.

Example:

```
DEFINE DATA LOCAL
1 #DATE (D)
END-DEFINE
...
MOVE D'2004-03-08' TO #DATE
...
```

The default date format is controlled by the profile parameter `DTFORM` (Date Format) as set by the Natural administrator.

### Time Constant

A time constant may be used in conjunction with a format T variable.

A time constant has the following format:

```
T'hh:ii:ss'
```

where *hh* represents hours, *ii* minutes and *ss* seconds.

Example:

```
DEFINE DATA LOCAL  
1 #TIME (T)  
END-DEFINE  
...  
MOVE T'11:33:00' TO #TIME  
...
```

### Extended Time Constant

A time variable (format T) can contain date and time information, date information being a subset of time information; however, with a “normal” time constant (prefix T) only the time information of a time variable can be handled:

```
T'hh:ii:ss'
```

With an extended time constant (prefix E), it is possible to handle the full content of a time variable, including the date information:

```
E'yyyy-mm-dd hh:ii:ss'
```

Apart from that, the use of an extended time constant in conjunction with a time variable is the same as for a normal time constant.



**Note:** The format in which the date information has to be specified in an extended time constant depends on the setting of the profile parameter DTFORM. The extended time constant shown above assumes DTFORM=I (international date format).

## Hexadecimal Constants

---

The following topics are covered below:

- [Hexadecimal Constants](#)



- Concatenation of Hexadecimal Constants

## Hexadecimal Constants

A hexadecimal constant may be used to enter a value which cannot be entered as a standard keyboard character.

A hexadecimal constant may contain 1 to 1073741824 bytes (1 GB) of alphanumeric characters.

A hexadecimal constant is prefixed with an H. The constant itself must be enclosed in apostrophes and may consist of the hexadecimal characters 0 - 9, A - F. Two hexadecimal characters are required to represent one byte of data.

The hexadecimal representation of a character varies, depending on whether your computer uses an ASCII or EBCDIC character set. When you transfer hexadecimal constants to another computer, you may therefore have to convert the characters.

ASCII examples:

```
H'313233'    (equivalent to the alphanumeric constant '123')
H'414243'    (equivalent to the alphanumeric constant 'ABC')
```

EBCDIC examples:

```
H'F1F2F3'    (equivalent to the alphanumeric constant '123')
H'C1C2C3'    (equivalent to the alphanumeric constant 'ABC')
```

When a hexadecimal constant is transferred to another field, it will be treated as an alphanumeric value (format A).

The data transfer of an alphanumeric value (format A) to a field which is defined with a format other than A,U or B is not allowed. Therefore, a hexadecimal constant used as initial value in a `DEFINE DATA` statement is rejected with the syntax error NAT0094 if the corresponding variable is not of format A, U or B.

Example:

```
DEFINE DATA LOCAL
1 #I(I2) INIT <H'000F'>      /* causes a NAT0094 syntax error
END-DEFINE                  ↵
```



**Note:** If a hexadecimal constant is output that contains any characters from the ranges H'00' to H'1F' or H'80' to H'A0', these characters will not be output, as they would be interpreted as terminal control characters. As of Version 2.2 these hex constants are not suppressed.

## Concatenation of Hexadecimal Constants

Hexadecimal constants may be concatenated by using a hyphen between the constants.

ASCII example:

```
H'414243' - H'444546' (equivalent to 'ABCDEF')
```

EBCDIC example:

```
H'C1C2C3' - H'C4C5C6' (equivalent to 'ABCDEF')
```

In this way, hexadecimal constants can also be concatenated with alphanumeric constants.

## Logical Constants

---

The logical constants `TRUE` and `FALSE` may be used to assign a logical value to a field defined with Format L.

Example:

```
DEFINE DATA LOCAL
1 #FLAG (L)
END-DEFINE
...
MOVE TRUE TO #FLAG
...
IF #FLAG ...
    statement ...
    MOVE FALSE TO #FLAG
END-IF
...
```

## Floating Point Constants

---

Floating point constants can be used with variables defined with format F.

Example:

```

DEFINE DATA LOCAL
1 #FLT1 (F4)
END-DEFINE
...
COMPUTE #FLT1 = -5.34E+2
...

```

## Attribute Constants

Attribute constants can be used with variables defined with format C (control variables). This type of constant must be enclosed within parentheses.

The following attributes may be used:

Attribute	Description
AD=D	default
AD=B	blinking
AD=I	intensified
AD=N	non-display
AD=V	reverse video
AD=U	underlined
AD=C	cursive/italic
AD=Y	dynamic attribute
AD=P	protected
CD=BL	blue
CD=GR	green
CD=NE	neutral
CD=PI	pink
CD=RE	red
CD=TU	turquoise
CD=YE	yellow

See also session parameters AD and CD.

Example:

```
DEFINE DATA LOCAL
1 #ATTR (C)
1 #FIELD (A10)
END-DEFINE
...
MOVE (AD=I CD=BL) TO #ATTR
...
INPUT #FIELD (CV=#ATTR)
...
```

## Handle Constants

---

The handle constant `NULL-HANDLE` can be used with object handles.

## Defining Named Constants

---

If you need to use the same constant value several times in a program, you can reduce the maintenance effort by defining a named constant:

- Define a field in the `DEFINE DATA` statement,
- assign a constant value to it, and
- use the field name in the program instead of the constant value.

Thus, when the value has to be changed, you only have to change it once in the `DEFINE DATA` statement and not everywhere in the program where it occurs.

You specify the constant value in angle brackets with the **keyword** `CONSTANT` after the field definition in the `DEFINE DATA` statement.

- If the value is alphanumeric, it must be enclosed in apostrophes.
- If the value is text in Unicode format, it must be preceded by the character `U` and must be enclosed in apostrophes.
- If the value is in hexadecimal Unicode format, it must be preceded by the characters `UH` and must be enclosed in apostrophes.

Example:

```
DEFINE DATA LOCAL
1 #FIELD A (N3) CONSTANT <100>
1 #FIELD B (A5) CONSTANT <'ABCDE'>
1 #FIELD C (U5) CONSTANT <U'ABCDE'>
1 #FIELD D (U5) CONSTANT <UH'00410042004300440045'>
END-DEFINE
...
```

During the execution of the program, the value of such a named constant cannot be modified.



# 18 Initial Values (and the RESET Statement)

---

- Default Initial Value of a User-Defined Variable/Array ..... 154
- Assigning an Initial Value to a User-Defined Variable/Array ..... 154
- Resetting a User-Defined Variable to its Initial Value ..... 156

This chapter describes the default initial values of user-defined variables, explains how you can assign an initial value to a user-defined variable and how you can use the `RESET` statement to reset the field value to its default initial value or the initial value defined for that variable in the `DEFINE DATA` statement.

## Default Initial Value of a User-Defined Variable/Array

---

If you specify no initial value for a field, the field will be initialized with a default initial value depending on its format:

Format	Default Initial Value
B, F, I, N, P	0
A, U	<i>blank</i>
L	F(ALSE)
D	D' '
T	T'00:00:00'
C	(AD=D)
Object Handle	NULL-HANDLE

## Assigning an Initial Value to a User-Defined Variable/Array

---

In the `DEFINE DATA` statement, you can assign an initial value to a user-defined variable. If the initial value is alphanumeric, it must be enclosed in apostrophes.

- [Assigning a Modifiable Initial Value](#)
- [Assigning a Constant Initial Value](#)
- [Assigning a Natural System Variable as Initial Value](#)
- [Assigning Characters as Initial Value for Alphanumeric Variables](#)

### Assigning a Modifiable Initial Value

If the variable/array is to be assigned a modifiable initial value, you specify the initial value in angle brackets with the keyword `INIT` after the variable definition in the `DEFINE DATA` statement. The value(s) assigned will be used each time the variable/array is referenced. The value(s) assigned can be modified during program execution.

Example:



```

DEFINE DATA LOCAL
1 #FIELDA (N3) INIT <100>
1 #FIELDB (A20) INIT <'ABC'>
END-DEFINE
...

```

### Assigning a Constant Initial Value

If the variable/array is to be treated as a named constant, you specify the initial value in angle brackets with the keyword `CONSTANT` after the variable definition in the `DEFINE DATA` statement. The constant value(s) assigned will be used each time the variable/array is referenced. The value(s) assigned cannot be modified during program execution.

Example:

```

DEFINE DATA LOCAL
1 #FIELDA (N3) CONST <100>
1 #FIELDB (A20) CONST <'ABC'>
END-DEFINE
...

```

### Assigning a Natural System Variable as Initial Value

The initial value for a field may also be the value of a [Natural system variable](#).

Example:

In this example, the system variable `*DATX` is used to provide the initial value.

```

DEFINE DATA LOCAL
1 #MYDATE (D) INIT < *DATX >
END-DEFINE
...

```

### Assigning Characters as Initial Value for Alphanumeric Variables

As initial value, a variable can also be filled, entirely or partially, with a specific single character or string of characters (only possible for alphanumeric variables).

- **Filling an entire field:**

With the option `FULL LENGTH <character(s)>`, the entire field is filled with the specified character(s).

In this example, the entire field will be filled with asterisks.

```
DEFINE DATA LOCAL
1 #FIELD (A25) INIT FULL LENGTH <'*'>
END-DEFINE
...
```

### ■ Filling the first $n$ positions of a field:

With the option `LENGTH  $n$  <character(s)>`, the first  $n$  positions of the field are filled with the specified character(s).

In this example, the first 4 positions of the field will be filled with exclamation marks.

```
DEFINE DATA LOCAL
1 #FIELD (A25) INIT LENGTH 4 <'!'>
END-DEFINE
...
```

## Resetting a User-Defined Variable to its Initial Value

---

The `RESET` statement is used to reset the value of a field. Two options are available:

- [Reset to Default Initial Value](#)
- [Reset to Initial Value Defined in DEFINE DATA](#)



### Notes:

1. A field declared with a `CONSTANT` clause in the `DEFINE DATA` statement may not be referenced in a `RESET` statement, since its content cannot be changed.
2. In reporting mode, the `RESET` statement may also be used to define a variable, provided that the program contains no `DEFINE DATA LOCAL` statement.

### Reset to Default Initial Value

`RESET` (without `INITIAL`) sets the content of each specified field to its **default initial value** depending on its format.

Example:

```

DEFINE DATA LOCAL
1 #FIELD A (N3) INIT <100>
1 #FIELD B (A20) INIT <'ABC'>
1 #FIELD C (I4) INIT <5>
END-DEFINE
...
...
RESET #FIELD A /* resets field value to default initial value
... ↵

```

### Reset to Initial Value Defined in DEFINE DATA

RESET INITIAL sets each specified field to the initial value as defined for the field in the DEFINE DATA statement.

For a field declared without INIT clause in the DEFINE DATA statement, RESET INITIAL has the same effect as RESET (without INITIAL).

Example:

```

DEFINE DATA LOCAL
1 #FIELD A (N3) INIT <100>
1 #FIELD B (A20) INIT <'ABC'>
1 #FIELD C (I4) INIT <5>
END-DEFINE
...
RESET INITIAL #FIELD A #FIELD B #FIELD C /* resets field values to initial values as ↵
defined in DEFINE DATA
...

```



# 19 Redefining Fields

---

- Using the REDEFINE Option of DEFINE DATA ..... 160
- Example Program Illustrating the Use of a Redefinition ..... 161

Redefinition is used to change the format of a field, or to divide a single field into segments.

## Using the REDEFINE Option of DEFINE DATA

The `REDEFINE` option of the `DEFINE DATA` statement can be used to redefine a single field - either a user-defined variable or a database field - as one or more new fields. A group can also be redefined.



**Important:** Dynamic variables are not allowed in a redefinition.

The `REDEFINE` option redefines byte positions of a field from left to right, regardless of the format. Byte positions must match between original field and redefined field(s).

The redefinition must be specified immediately after the definition of the original field.

### Example 1:

In the following example, the database field `BIRTH` is redefined as three new user-defined variables:

```
DEFINE DATA LOCAL
01 EMPLOY-VIEW VIEW OF STAFFDDM
  02 NAME
  02 BIRTH
  02 REDEFINE BIRTH
    03 #BIRTH-YEAR (N4)
    03 #BIRTH-MONTH (N2)
    03 #BIRTH-DAY (N2)
END-DEFINE
...
```

### Example 2:

In the following example, the group `#VAR2`, which consists of two user-defined variables of format `N` and `P` respectively, is redefined as a variable of format `A`:

```
DEFINE DATA LOCAL
01 #VAR1 (A15)
01 #VAR2
  02 #VAR2A (N4.1)
  02 #VAR2B (P6.2)
01 REDEFINE #VAR2
  02 #VAR2RD (A10)
END-DEFINE
...
```

With the notation `FILLER nX` you can define `n` filler bytes - that is, segments which are not to be used - in the field that is being redefined. (The definition of trailing filler bytes is optional.)

**Example 3:**

In the following example, the user-defined variable `#FIELD` is redefined as three new user-defined variables, each of format/length `A2`. The `FILLER` notations indicate that the 3rd and 4th and 7th to 10th bytes of the original field are not be used.

```
DEFINE DATA LOCAL
1 #FIELD (A12)
1 REDEFINE #FIELD
  2 #RFIELD1 (A2)
  2 FILLER 2X
  2 #RFIELD2 (A2)
  2 FILLER 4X
  2 #RFIELD3 (A2)
END-DEFINE
...
```

**Example Program Illustrating the Use of a Redefinition**

The following program illustrates the use of a redefinition:

```
** Example 'DDATAX01': DEFINE DATA
*****
DEFINE DATA LOCAL
01 VIEWEMP VIEW OF EMPLOYEES
  02 NAME
  02 FIRST-NAME
  02 SALARY (1:1)
*
01 #PAY (N9)
01 REDEFINE #PAY
  02 FILLER 3X
  02 #USD (N3)
  02 #000 (N3)
END-DEFINE
*
READ (3) VIEWEMP BY NAME STARTING FROM 'JONES'
  MOVE SALARY (1) TO #PAY
  DISPLAY NAME FIRST-NAME #PAY #USD #000
END-READ
END
```

Output of Program `DDATAX01`:

Note how `#PAY` and the fields resulting from its definition are displayed:

## Redefining Fields

---

Page 1 04-11-11 14:15:54

NAME	FIRST-NAME	#PAY	#USD	#000
JONES	VIRGINIA	46000	46	0
JONES	MARSHA	50000	50	0
JONES	ROBERT	31000	31	0

←



# 20 Arrays

---

▪ Defining Arrays .....	164
▪ Initial Values for Arrays .....	165
▪ Assigning Initial Values to One-Dimensional Arrays .....	165
▪ Assigning Initial Values to Two-Dimensional Arrays .....	166
▪ A Three-Dimensional Array .....	170
▪ Arrays as Part of a Larger Data Structure .....	172
▪ Database Arrays .....	173
▪ Using Arithmetic Expressions in Index Notation .....	173
▪ Arithmetic Support for Arrays .....	174

Natural supports the processing of arrays. Arrays are multi-dimensional tables, that is, two or more logically related elements identified under a single name. Arrays can consist of single data elements of multiple dimensions or hierarchical data structures which contain repetitive structures or individual elements.

## Defining Arrays

---

In Natural, an array can be one-, two- or three-dimensional. It can be an independent variable, part of a larger data structure or part of a database view.



**Important:** Dynamic variables are not allowed in an array definition.

### ▶ To define a one-dimensional array

- After the format and length, specify a slash followed by a so-called “index notation”, that is, the number of occurrences of the array.

For example, the following one-dimensional array has three occurrences, each occurrence being of format/length A10:

```
DEFINE DATA LOCAL
1 #ARRAY (A10/1:3)
END-DEFINE
...
```

### ▶ To define a two-dimensional array

- Specify an index notation for both dimensions:

```
DEFINE DATA LOCAL
1 #ARRAY (A10/1:3,1:4)
END-DEFINE
...
```

A two-dimensional array can be visualized as a table. The array defined in the example above would be a table that consists of 3 “rows” and 4 “columns”:

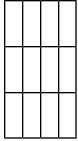

## Initial Values for Arrays

To assign initial values to one or more occurrences of an array, you use an `INIT` specification, similar to that for “**ordinary**” variables, as shown in the following examples.

### Assigning Initial Values to One-Dimensional Arrays

The following examples illustrate how initial values are assigned to a one-dimensional array.

- To assign an initial value to one occurrence, you specify:

```
1 #ARRAY (A1/1:3) INIT (2) <'A'>
```

A is assigned to the second occurrence.

- To assign the same initial value to all occurrences, you specify:

```
1 #ARRAY (A1/1:3) INIT ALL <'A'>
```

A is assigned to every occurrence. Alternatively, you could specify:

```
1 #ARRAY (A1/1:3) INIT (*) <'A'>
```

- To assign the same initial value to a range of several occurrences, you specify:

```
1 #ARRAY (A1/1:3) INIT (2:3) <'A'>
```

A is assigned to the second to third occurrence.

- To assign a different initial value to every occurrence, you specify:

```
1 #ARRAY (A1/1:3) INIT <'A','B','C'>
```

A is assigned to the first occurrence, B to the second, and C to the third.

- To assign different initial values to some (but not all) occurrences, you specify:

```
1 #ARRAY (A1/1:3) INIT (1) <'A'> (3) <'C'>
```

A is assigned to the first occurrence, and C to the third; no value is assigned to the second occurrence.

Alternatively, you could specify:

```
1 #ARRAY (A1/1:3) INIT <'A',, 'C'>
```

- If fewer initial values are specified than there are occurrences, the last occurrences remain empty:

```
1 #ARRAY (A1/1:3) INIT <'A','B'>
```

A is assigned to the first occurrence, and B to the second; no value is assigned to the third occurrence.

## Assigning Initial Values to Two-Dimensional Arrays

---

This section illustrates how initial values are assigned to a two-dimensional array. The following topics are covered:

- [Preliminary Information](#)
- [Assigning the Same Value](#)
- [Assigning Different Values](#)

### Preliminary Information

For the examples shown in this section, let us assume a two-dimensional array with three occurrences in the first dimension (“rows”) and four occurrences in the second dimension (“columns”):

```
1 #ARRAY (A1/1:3,1:4)
```

**Vertical: First Dimension (1:3), Horizontal: Second Dimension (1:4):**

(1,1)	(1,2)	(1,3)	(1,4)
(2,1)	(2,2)	(2,3)	(2,4)
(3,1)	(3,2)	(3,3)	(3,4)

The first set of examples illustrates how the *same* initial value is assigned to occurrences of a two-dimensional array; the second set of examples illustrates how *different* initial values are assigned.

In the examples, please note in particular the usage of the notations \* and V. Both notations refer to *all* occurrences of the dimension concerned: \* indicates that all occurrences in that dimension are initialized with the *same* value, while V indicates that all occurrences in that dimension are initialized with *different* values.

**Assigning the Same Value**

- To assign an initial value to one occurrence, you specify:

```
1 #ARRAY (A1/1:3,1:4) INIT (2,3) <'A'>
```

	A		

- To assign the same initial value to one occurrence in the second dimension - in all occurrences of the first dimension - you specify:

```
1 #ARRAY (A1/1:3,1:4) INIT (*,3) <'A'>
```

	A
	A
	A

- To assign the same initial value to a range of occurrences in the first dimension - in all occurrences of the second dimension - you specify:

```
1 #ARRAY (A1/1:3,1:4) INIT (2:3,*) <'A'>
```

A	A	A	A
A	A	A	A

- To assign the same initial value to a range of occurrences in each dimension, you specify:

```
1 #ARRAY (A1/1:3,1:4) INIT (2:3,1:2) <'A'>
```

A	A		
A	A		

- To assign the same initial value to all occurrences (in both dimensions), you specify:

```
1 #ARRAY (A1/1:3,1:4) INIT ALL <'A'>
```

A	A	A	A
A	A	A	A
A	A	A	A

Alternatively, you could specify:

```
1 #ARRAY (A1/1:3,1:4) INIT (*,*) <'A'>
```

### Assigning Different Values

- ```
1 #ARRAY (A1/1:3,1:4) INIT (V,2) <'A','B','C'>
```

|   |  |  |
|---|--|--|
| A |  |  |
| B |  |  |
| C |  |  |

1 #ARRAY (A1/1:3,1:4) INIT (V,2:3) <'A','B','C'>

|   |   |  |  |
|---|---|--|--|
| A | A |  |  |
| B | B |  |  |
| C | C |  |  |

1 #ARRAY (A1/1:3,1:4) INIT (V,\*) <'A','B','C'>

|   |   |   |   |
|---|---|---|---|
| A | A | A | A |
| B | B | B | B |
| C | C | C | C |

1 #ARRAY (A1/1:3,1:4) INIT (V,\*) <'A',.,'C'>

|   |   |   |   |
|---|---|---|---|
| A | A | A | A |
|   |   |   |   |
| C | C | C | C |

1 #ARRAY (A1/1:3,1:4) INIT (V,\*) <'A','B'>

|   |   |   |   |
|---|---|---|---|
| A | A | A | A |
| B | B | B | B |
|   |   |   |   |

1 #ARRAY (A1/1:3,1:4) INIT (V,1) <'A','B','C'> (V,3) <'D','E','F'>

|   |   |  |  |
|---|---|--|--|
| A | D |  |  |
| B | E |  |  |
| C | F |  |  |

1 #ARRAY (A1/1:3,1:4) INIT (3,V) <'A','B','C','D'>

|   |   |   |   |
|---|---|---|---|
|   |   |   |   |
|   |   |   |   |
| A | B | C | D |

■ 1 #ARRAY (A1/1:3,1:4) INIT (\*,V) <'A','B','C','D'>

|   |   |   |   |
|---|---|---|---|
| A | B | C | D |
| A | B | C | D |
| A | B | C | D |

■ 1 #ARRAY (A1/1:3,1:4) INIT (2,1) <'A'> (\*,2) <'B'> (3,3) <'C'> (3,4) <'D'>

|   |   |   |   |
|---|---|---|---|
|   | B |   |   |
| A | B |   |   |
|   | B | C | D |

■ 1 #ARRAY (A1/1:3,1:4) INIT (2,1) <'A'> (V,2) <'B','C','D'> (3,3) <'E'> (3,4) <'F'>

|   |   |   |   |
|---|---|---|---|
|   | B |   |   |
| A | C |   |   |
|   | D | E | F |

## A Three-Dimensional Array

---

A three-dimensional array could be visualized as follows:



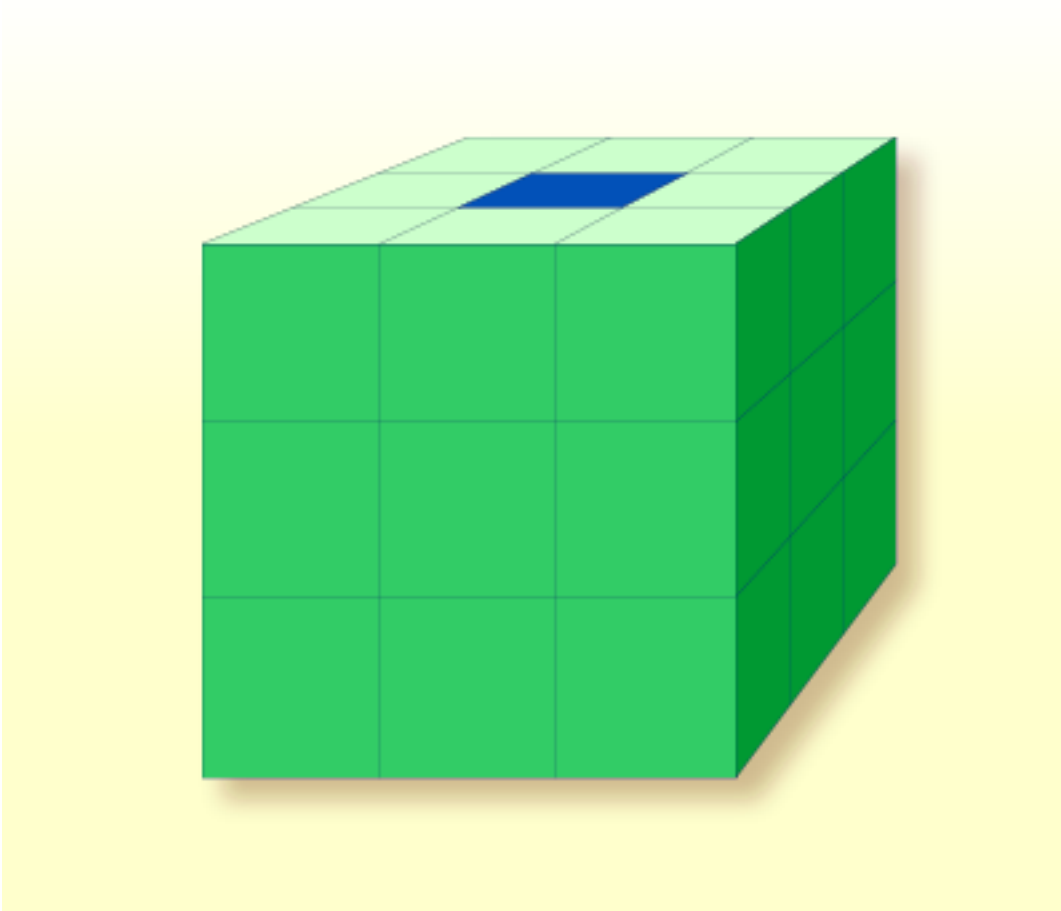

The array illustrated here would be defined as follows (at the same time assigning an initial value to the highlighted field in Row 1, Column 2, Plane 2):

```
DEFINE DATA LOCAL
1 #ARRAY2
  2 #ROW (1:4)
    3 #COLUMN (1:3)
      4 #PLANE (1:3)
        5 #FIELD2 (P3) INIT (1,2,2) <100>
END-DEFINE
...
```

If defined as a local data area in the source editor, the same array would look as follows:

| I | T | L | Name      | F | Leng | Index/Init/EM/Name/Comment |
|---|---|---|-----------|---|------|----------------------------|
|   |   |   | 1 #ARRAY2 |   |      |                            |
|   |   |   | 2 #ROW    |   |      | (1:4)                      |
|   |   |   | 3 #COLUMN |   |      | (1:3)                      |
|   |   |   | 4 #PLANE  |   |      | (1:3)                      |
| I |   |   | 5 #FIELD2 | P | 3    | ↵                          |

## Arrays as Part of a Larger Data Structure

The multiple dimensions of an array make it possible to define data structures analogous to COBOL or PL1 structures.

### Example:

```

DEFINE DATA LOCAL
1 #AREA
  2 #FIELD1 (A10)
  2 #GROUP1 (1:10)
    3 #FIELD2 (P2)
    3 #FIELD3 (N1/1:4)
END-DEFINE
...

```

In this example, the data area #AREA has a total size of:

$$10 + (10 * (2 + (1 * 4))) \text{ bytes} = 70 \text{ bytes}$$

#FIELD1 is alphanumeric and 10 bytes long. #GROUP1 is the name of a sub-area within #AREA, which consists of 2 fields and has 10 occurrences. #FIELD2 is packed numeric, length 2. #FIELD3 is the second field of #GROUP1 with four occurrences, and is numeric, length 1.

To reference a particular occurrence of #FIELD3, two indices are required: first, the occurrence of #GROUP1 must be specified, and second, the particular occurrence of #FIELD3 must also be specified. For example, in an ADD statement later in the same program, #FIELD3 would be referenced as follows:

```

ADD 2 TO #FIELD3 (3,2)

```

## Database Arrays

Adabas supports array structures within the database in the form of **multiple-value fields** and **periodic groups**. These are described under *Database Arrays*.

The following example shows a DEFINE DATA view containing a multiple-value field:

```
DEFINE DATA LOCAL
1 EMPLOYEES-VIEW VIEW OF EMPLOYEES
  2 NAME
  2 ADDRESS-LINE (1:10) /* <--- MULTIPLE-VALUE FIELD
END-DEFINE
...
```

The same view in a local data area would look as follows:

| I | T | L | Name           | F | Leng | Index/Init/EM/Name/Comment |
|---|---|---|----------------|---|------|----------------------------|
| V | 1 |   | EMPLOYEES-VIEW |   |      | EMPLOYEES                  |
|   | 2 |   | NAME           | A | 20   |                            |
| M | 2 |   | ADDRESS-LINE   | A | 20   | (1:10) /* MU-FIELD         |

## Using Arithmetic Expressions in Index Notation

A simple arithmetic expression may also be used to express a range of occurrences in an array.

Examples:

|              |                                                                                            |
|--------------|--------------------------------------------------------------------------------------------|
| MA (I:I+5)   | Values of the field MA are referenced, beginning with value I and ending with value I+5.   |
| MA (I+2:J-3) | Values of the field MA are referenced, beginning with value I+2 and ending with value J-3. |

Only the arithmetic operators plus (+) and minus (-) may be used in index expressions.

## Arithmetic Support for Arrays

Arithmetic support for arrays include operations at array level, at row/column level, and at individual element level.

Only simple arithmetic expressions are permitted with array variables, with only one or two operands and an optional third variable as the receiving field.

Only the arithmetic operators plus (+) and minus (-) are allowed for expressions defining index ranges.

### Examples of Array Arithmetics

The following examples assume the following field definitions:

```
DEFINE DATA LOCAL
01 #A (N5/1:10,1:10)
01 #B (N5/1:10,1:10)
01 #C (N5)
END-DEFINE
...
```

1. `ADD #A(*,*) TO #B(*,*)`

The result operand, array #B, contains the addition, element by element, of the array #A and the original value of array #B.

2. `ADD 4 TO #A(*,2)`

The second column of the array #A is replaced by its original value plus 4.

3. `ADD 2 TO #A(2,*)`

The second row of the array #A is replaced by its original value plus 2.

4. `ADD #A(2,*) TO #B(4,*)`

The value of the second row of array #A is added to the fourth row of array #B.

5. `ADD #A(2,*) TO #B(*,2)`

This is an illegal operation and will result in a syntax error. Rows may only be added to rows and columns to columns.

---

6. ADD #A(2,\*) TO #C

All values in the second row of the array #A are added to the scalar value #C.

7. ADD #A(2,5:7) TO #C

The fifth, sixth, and seventh column values of the second row of array #A are added to the scalar value #C.



# 21 X-Arrays

---

|                                                |     |
|------------------------------------------------|-----|
| ▪ Definition .....                             | 178 |
| ▪ Storage Management of X-Arrays .....         | 179 |
| ▪ Storage Management of X-Group Arrays .....   | 179 |
| ▪ Referencing an X-Array .....                 | 181 |
| ▪ Parameter Transfer with X-Arrays .....       | 182 |
| ▪ Parameter Transfer with X-Group Arrays ..... | 183 |
| ▪ X-Array of Dynamic Variables .....           | 184 |
| ▪ Lower and Upper Bound of an Array .....      | 185 |

When an ordinary array field is defined, you have to specify the index bounds exactly, hence the number of occurrences for each dimension. At runtime, the complete array field is existent by default; each of its defined occurrences can be accessed without performing additional allocation operations. The size layout cannot be changed anymore; you may neither add nor remove field occurrences.

However, if the number of occurrences needed is unknown at development time, but you want to flexibly increase or decrease the number of the array fields at runtime, you should use what is called an X-array (eXtensible array).

An X-array can be resized at runtime and can help you manage memory more efficiently. For example, you can use a large number of array occurrences for a short time and then reduce memory when the application is no longer using the array.

### Definition

---

An X-array is an array of which the number of occurrences is undefined at compile time. It is defined in a `DEFINE DATA` statement by specifying an asterisk (\*) for at least one index bound of at least one array dimension. An asterisk (\*) character in the index definition represents a variable index bound which can be assigned to a definite value during program execution. Only one bound - either upper or lower - may be defined as variable, but not both.

An X-array can be defined whenever a (fixed) array can be defined, i.e. at any level or even as an indexed group. It cannot be used to access MU-/PE-fields of a database view. A multidimensional array may have a mixture of constant and variable bounds.

Example:

```
DEFINE DATA LOCAL
1 #X-ARR1 (A5/1:*)          /* lower bound is fixed at 1, upper bound is variable
1 #X-ARR2 (A5/*)          /* shortcut for (A5/1:*)
1 #X-ARR3 (A5/*:100)      /* lower bound is variable, upper bound is fixed at 100
1 #X-ARR4 (A5/1:10,1:*)   /* 1st dimension has a fixed index range with (1:10)
END-DEFINE                /* 2nd dimension has fixed lower bound 1 and variable ←
upper bound
```



## Storage Management of X-Arrays

Occurrences of an X-array must be allocated explicitly before they can be accessed. To increase or decrease the number of occurrences of a dimension, the statements `EXPAND`, `RESIZE` and `REDUCE` may be used.

However, the number of dimensions of the X-array (1, 2 or 3 dimensions) cannot be changed.

Example:

```

DEFINE DATA LOCAL
1 #X-ARR(I4/10:*)
END-DEFINE
EXPAND ARRAY #X-ARR TO (10:10000)
/* #X-ARR(10) to #X-ARR(10000) are accessible
WRITE *LBOUND(#X-ARR)           /* is 10
   *UBOUND(#X-ARR)             /* is 10000
   *OCCURRENCE(#X-ARR)        /* is 9991
#X-ARR(*) := 4711                /* same as #X-ARR(10:10000) := 4711
/* resize array from current lower bound=10 to upper bound =1000
RESIZE ARRAY #X-ARR TO (*:1000)
/* #X-ARR(10) to #X-ARR(1000) are accessible
/* #X-ARR(1001) to #X-ARR(10000) are released
WRITE *LBOUND(#X-ARR)           /* is 10
   *UBOUND(#X-ARR)             /* is 1000
   *OCCURRENCE(#X-ARR)        /* is 991
/* release all occurrences
REDUCE ARRAY #X-ARR TO 0
WRITE *OCCURRENCE(#X-ARR)       /* is 0

```

## Storage Management of X-Group Arrays

If you want to increase or decrease occurrences of X-group arrays, you must distinguish between independent and dependent dimensions.

A dimension which is specified directly (not inherited) for an X-(group) array is *independent*.

A dimension which is *not* specified directly, but inherited for an array is *dependent*.

Only independent dimensions of an X-array can be changed in the statements `EXPAND`, `RESIZE` and `REDUCE`; dependent dimensions must be changed using the name of the corresponding X-group array which owns this dimension as independent dimension.

**Example - Independent/Dependent Dimensions:**

```

DEFINE DATA LOCAL
1 #X -GROUP-ARR1(1:*) /* (1:*)
2 #X-ARR1 (I4) /* (1:*)
2 #X-ARR2 (I4/2:*) /* (1:*,2:*)
2 #X-GROUP-ARR2 /* (1:*)
3 #X-ARR3 (I4) /* (1:*)
3 #X-ARR4 (I4/3:*) /* (1:*,3:*)
3 #X-ARR5 (I4/4:*, 5:*) /* (1:*,4:*,5:*)
END-DEFINE
    
```

The following table shows whether the dimensions in the above program are independent or dependent.

| Name           | Dependent Dimension | Independent Dimension |
|----------------|---------------------|-----------------------|
| #X -GROUP-ARR1 |                     | (1:*)                 |
| #X-ARR1        | (1:*)               |                       |
| #X-ARR2        | (1:*)               | (2:*)                 |
| #X -GROUP-ARR2 | (1:*)               |                       |
| #X-ARR3        | (1:*)               |                       |
| #X-ARR4        | (1:*)               | (3:*)                 |
| #X-ARR5        | (1:*)               | (4:*,5:*)             |

The only index notation permitted for a dependent dimension is either a single asterisk (\*), a range defined with asterisks (\*:\*) or the index bounds defined.

This is to indicate that the bounds of the dependent dimension must be kept as they are and cannot be changed.

The occurrences of the dependent dimensions can only be changed by manipulating the corresponding array groups.

```

EXPAND ARRAY #X-GROUP-ARR1 TO (1:11) /* #X-ARR1(1:11) are allocated
/* #X-ARR3(1:11) are allocated
EXPAND ARRAY #X-ARR2 TO (*:*, 2:12) /* #X-ARR2(1:11, 2:12) are allocated
EXPAND ARRAY #X-ARR2 TO (1:*, 2:12) /* same as before
EXPAND ARRAY #X-ARR2 TO (* , 2:12) /* same as before
EXPAND ARRAY #X-ARR4 TO (*:*, 3:13) /* #X-ARR4(1:11, 3:13) are allocated
EXPAND ARRAY #X-ARR5 TO (*:*, 4:14, 5:15) /* #X-ARR5(1:11, 4:14, 5:15) are allocated
    
```

The EXPAND statements may be coded in an arbitrary order.

The following use of the EXPAND statement is not allowed, since the arrays only have dependent dimensions.

```
EXPAND ARRAY #X-ARR1 TO ...
EXPAND ARRAY #X-GROUP-ARR2 TO ...
EXPAND ARRAY #X-ARR3 TO ...
```

## Referencing an X-Array

The occurrences of an X-array must be allocated by an `EXPAND` or `RESIZE` statement before they can be accessed.

As a general rule, an attempt to address a non-existent X-array occurrence leads to a runtime error. In some statements, however, the access to a non-materialized X-array field does not cause an error situation if all occurrences of an X-array are referenced using the complete range notation, for example: `#X-ARR(*)`. This applies to

- parameters used in a `CALL` statement,
- parameters used in the statements `CALLNAT`, `PERFORM` or `OPEN DIALOG`, if defined as optional parameters,
- source fields used in a `COMPRESS` statement,
- output fields supplied in a `PRINT` statement,
- fields referenced in a `RESET` statement.

If individual occurrences of a non-materialized X-array are referenced in one of these statements, a corresponding error message is issued.

Example:

```
DEFINE DATA LOCAL
1 #X-ARR (A10/1:*) /* X-array only defined, but not allocated
END-DEFINE
RESET #X-ARR(*) /* no error, because complete field referenced with (*)
RESET #X-ARR(1:3) /* runtime error, because individual occurrences (1:3) are ←
referenced
END ←
```

The asterisk (\*) notation in an array reference stands for the complete range of a dimension. If the array is an X-array, the asterisk is the index range of the currently allocated lower and upper bound values, which are determined by the system variables `*LBOUND` and `*UBOUND`.

## Parameter Transfer with X-Arrays

X-arrays that are used as parameters are treated in the same way as constant arrays with regard to the verification of the following:

- format,
- length,
- dimension or
- number of occurrences.

In addition, X-array parameters can also change the number of occurrences using the statement `RESIZE`, `REDUCE` or `EXPAND`. The question if a resize of an X-array parameter is permitted depends on three factors:

- the type of parameter transfer used, that is by reference or by value,
- the definition of the caller or parameter X-array, and
- the type of X-array range being passed on (complete range or subrange).

The following tables demonstrate when an `EXPAND`, `RESIZE` or `REDUCE` statement can be applied to an X-array parameter.

### Example with Call By Value

| Caller                                                                | Parameter |                |         |
|-----------------------------------------------------------------------|-----------|----------------|---------|
|                                                                       | Static    | Variable (1:V) | X-Array |
| Static                                                                | no        | no             | yes     |
| X-array subrange, for example:<br><code>CALLNAT...#XA(1:5)</code>     | no        | no             | yes     |
| X-array complete range, for example:<br><code>CALLNAT...#XA(*)</code> | no        | no             | yes     |

## Call By Reference/Call By Value Result

| Caller                                                                                                                               | Parameter |                |                                                               |                                                               |
|--------------------------------------------------------------------------------------------------------------------------------------|-----------|----------------|---------------------------------------------------------------|---------------------------------------------------------------|
|                                                                                                                                      | Static    | Variable (1:V) | X-Array with a fixed lower bound, e.g.                        | X-Array with a fixed upper bound, e.g.                        |
|                                                                                                                                      |           |                | DEFINE DATA $\leftrightarrow$<br>PARAMETER<br>1 #PX (A10/1:*) | DEFINE DATA $\leftrightarrow$<br>PARAMETER<br>1 #PX (A10/*:1) |
| Static                                                                                                                               | no        | no             | no                                                            | no                                                            |
| X-array subrange, for example:<br><br>CALLNAT...#XA(1:5)                                                                             | no        | no             | no                                                            | no                                                            |
| X-Array with a fixed lower bound, complete range, for example:<br><br>DEFINE DATA LOCAL<br>1 #XA(A10/1:*)<br>...<br>CALLNAT...#XA(*) | no        | no             | yes                                                           | no                                                            |
| X-Array with a fixed upper bound, complete range, for example:<br><br>DEFINE DATA LOCAL<br>1 #XA(A10/*:1)<br>...<br>CALLNAT...#XA(*) | no        | no             | no                                                            | yes                                                           |

## Parameter Transfer with X-Group Arrays

The declaration of an X-group array implies that each element of the group will have the same values for upper boundary and lower boundary. Therefore, the number of occurrences of dependent dimensions of fields of an X-group array can only be changed when the group name of the X-group array is given with a RESIZE, REDUCE or EXPAND statement (see [Storage Management of X-Group Arrays](#) above).

Members of X-group arrays may be transferred as parameters to X-group arrays defined in a parameter data area. The group structures of the caller and the callee need not necessarily be

identical. A RESIZE, REDUCE or EXPAND done by the callee is only possible as far as the X-group array of the caller stays consistent.

### Example - Elements of X-Group Array Passed as Parameters:

Program:

```
DEFINE DATA LOCAL
1 #X-GROUP-ARR1(1:*)          /* (1:*)
  2 #X-ARR1 (I4)              /* (1:*)
  2 #X-ARR2 (I4)              /* (1:*)
1 #X-GROUP-ARR2(1:*)        /* (1:*)
  2 #X-ARR3 (I4)              /* (1:*)
  2 #X-ARR4 (I4)              /* (1:*)
END-DEFINE
...
CALLNAT ... #X-ARR1(*) #X-ARR4(*)
...
END
```

Subprogram:

```
DEFINE DATA PARAMETER
1 #X-GROUP-ARR(1:*)          /* (1:*)
  2 #X-PAR1 (I4)              /* (1:*)
  2 #X-PAR2 (I4)              /* (1:*)
END-DEFINE
...
RESIZE ARRAY #X-GROUP-ARR to (1:5)
...
END
```

The RESIZE statement in the subprogram is not possible. It would result in an inconsistent number of occurrences of the fields defined in the X-group arrays of the program.

## X-Array of Dynamic Variables

---

An X-array of dynamic variables may be allocated by first specifying the number of occurrences using the EXPAND statement and then assigning a value to the previously allocated array occurrences.

**Example:**

```

DEFINE DATA LOCAL
  1 #X-ARRAY(A/1:*)  DYNAMIC
END-DEFINE
EXPAND ARRAY  #X-ARRAY TO (1:10)
  /* allocate #X-ARRAY(1) to #X-ARRAY(10) with zero length.
  /* *LENGTH(#X-ARRAY(1:10)) is zero
#X-ARRAY(*) := 'abc'
  /* #X-ARRAY(1:10) contains 'abc',
  /* *LENGTH(#X-ARRAY(1:10)) is 3
EXPAND ARRAY  #X-ARRAY TO (1:20)
  /* allocate #X-ARRAY(11) to #X-ARRAY(20) with zero length
  /* *LENGTH(#X-ARRAY(11:20)) is zero
#X-ARRAY(11:20) := 'def'
  /* #X-ARRAY(11:20) contains 'def'
  /* *LENGTH(#X-ARRAY(11:20)) is 3

```

## Lower and Upper Bound of an Array

The system variables \*LBOUND and \*UBOUND contain the current lower and upper bound of an array for the specified dimension(s): (1,2 or 3).

If no occurrences of an X-array have been allocated, the access to \*LBOUND or \*UBOUND is undefined for the variable index bounds, that is, for the boundaries that are represented by an asterisk (\*) character in the index definition, and leads to a runtime error. In order to avoid a runtime error, the system variable \*OCCURRENCE may be used to check against zero occurrences before \*LBOUND or \*UBOUND is evaluated:

**Example:**

```

IF *OCCURRENCE (#A) NE 0 AND *UBOUND(#A) < 100 THEN ...

```





# IV

## User-Defined Functions

---



# 22

## User-Defined Functions

---

|                                                          |     |
|----------------------------------------------------------|-----|
| ▪ Introduction to User-Defined Functions .....           | 190 |
| ▪ Restrictions .....                                     | 191 |
| ▪ Function Call versus Subprogram Call .....             | 191 |
| ▪ Function Definition (DEFINE FUNCTION) .....            | 194 |
| ▪ Symbolic and Variable Function Call .....              | 194 |
| ▪ Function Result and Parameters .....                   | 194 |
| ▪ Explicit Prototype Definition (DEFINE PROTOTYPE) ..... | 195 |
| ▪ Implicit (Automatic) Prototype Definition .....        | 195 |
| ▪ Prototype Cast (PT Clause) .....                       | 196 |
| ▪ Intermediate Result Definition (IR Clause) .....       | 196 |
| ▪ Combinations of Possible Prototype Definitions .....   | 196 |
| ▪ Evaluation Sequence of Functions in Statements .....   | 198 |
| ▪ Using a Function as a Statement .....                  | 200 |

Related topics:

- Natural object type **function**
- **Function Call**
- Natural statements `DEFINE FUNCTION`, `DEFINE PROTOTYPE`

## Introduction to User-Defined Functions

---

A user-defined function is a programming object of type **function**, containing Natural statements which implement a specific functional task. The invocation of a user-defined function (“function call”) usually has a number of parameters and returns a result.

The syntactical representation of a **function call** is the function name (*call-name*) followed by a special bracket notation containing the parameters, which is, for example: `FCTNAME(<...>)`.

A function can be called from any place within a Natural statement where an operand is expected which is only *read*, but not *modified*. The result returned by the function is processed by the statement at the place where the function call is embedded, like a field containing the same value.

A function can also be called in a stand-alone mode, outside of any Natural statement. In this case, the function result is not processed.

Usually, the result value returned by the function depends on the parameters provided with the function call. As well as with a Natural subprogram, a parameter can be defined within a function as a “by reference”, “by value” or “by value result” field. This makes it possible to provide parameter values in a function call which are only transfer compatible to what is defined in the function definition. Moreover, it allows you to exchange data between the calling object and the function not only via the function result, but also via parameters. The correctness of the parameter list and the compatibility of the result value is checked at compilation, either by means of an existing cataloged function object or by means of a result and parameter layout definition described with a `DEFINE PROTOTYPE` statement.

All function calls used in a Natural statement are evaluated in a separate step before the statement execution is started. They are evaluated in the same order in which they appear in the statement.

## Restrictions

---

At some places in a programming object, function calls cannot be used. This includes

- positions where the operand value is changed by the Natural statement;
- all kinds of database calls (for example, FIND, READ);
- DEFINE DATA statement;
- IF BREAK statement;
- AT BREAK statement;
- array index expressions;
- Natural system functions (for example, AVER, SUM);
- parameters of a function call.

## Function Call versus Subprogram Call

---

The following is a comparison of the characteristics of a function call with those of a subprogram call.

- [What is similar?](#)
- [What is different?](#)
- [Example of a Function Call](#)
- [Example of a Subprogram Call](#)

### What is similar?

The following similarities exist between a function call and a subprogram call:

- The programming code forming the routine logic is coded inside a separate object, either in a function or a subprogram.
- Parameters are defined in the object using a DEFINE DATA PARAMETER statement, with various communication modes (for example, “by value”).

## What is different?

The following differences exist between a function call and a subprogram call:

- A function call can be used at any position in a Natural statement where a read-only operand is possible (for exceptions, see [Restrictions](#)), whereas subprograms can be invoked only via the CALLNAT statement.
- A function returns a result value which can instantly be processed by the statement that includes the function call. The use of a temporary variable is not required. A CALLNAT statement can only return data via its parameters. To process such a value with another statement, it needs to be declared as an explicit variable.
- Parameters and the result of a function call are always verified if the called function already exists at compilation time. Subprogram calls are checked only if the compiler option PCHECK is set to ON.
- The name of a function, which is used to call the function, is defined within the DEFINE FUNCTION statement and may differ from the name of the object containing the function. Similar to subroutines, the name of a function may have up to 32 characters. A subprogram is called by the name of the subprogram object. Therefore, the maximum name length is limited to 8 characters.

## Example of a Function Call

The following example shows a program calling a function, and the function definition created with a DEFINE FUNCTION statement.

### Program Calling the Function

```
** Example 'FUNCA01': Calling a function (Program)
*****
*
WRITE 'Function call' F#ADD(< 2,3 >) /* Function call.
                                     /* No temporary variables needed.
*
END
```

### Definition of Function F#ADD

```
** Example 'FUNCA02': Calling a function (Function)
*****
DEFINE FUNCTION F#ADD
  RETURNS #RESULT (I4)
  DEFINE DATA PARAMETER
    1 #SUMMAND1 (I4) BY VALUE
    1 #SUMMAND2 (I4) BY VALUE
  END-DEFINE
  /*
  #RESULT := #SUMMAND1 + #SUMMAND2
  /*
```

```
END-FUNCTION
*
END ↵
```

### Example of a Subprogram Call

To implement the same functionality as shown in the example of a function call by using a subprogram call instead, you need to specify temporary variables.

### Program Calling the Subprogram

The following example shows a program calling a subprogram, involving the use of a temporary variable.

```
** Example 'FUNCA303': Calling a subprogram (Program)
*****
DEFINE DATA LOCAL
  1 #RESULT (I4) INIT <0>
END-DEFINE
*
CALLNAT 'FUNCA304' #RESULT 2 3 /* Result is stored in #RESULT.
*
WRITE '=' #RESULT /* Print out the result of the
/* subprogram.
*
END
```

### Called Subprogram FUNCA304

```
** Example 'FUNCA304': Calling a subprogram (Subprogram)
*****
DEFINE DATA PARAMETER
  1 #RESULT (I4) BY VALUE RESULT
  1 #SUMMAND1 (I4) BY VALUE
  1 #SUMMAND2 (I4) BY VALUE
END-DEFINE
*
#RESULT := #SUMMAND1 + #SUMMAND2
*
END ↵
```

## Function Definition (DEFINE FUNCTION)

---

A function is created in a separate Natural object of type **function**. It contains a single `DEFINE FUNCTION` statement, which defines the parameter interface, the result value and the program code forming the operation logic.

## Symbolic and Variable Function Call

---

There are two modes to call a function, either in a direct form or indirect form. In the direct form (denoted as “**symbolic**” function call), the function name specified in the call is exactly the name of the function itself. In the indirect form (denoted as “**variable**” function call), the name specified in the function call is an alphanumeric variable with any name, which contains the name of the called function at runtime.

To define a variable function call, it is always necessary to use a `DEFINE PROTOTYPE VARIABLE` statement. Otherwise, the function call is assumed to be a symbolic function call; this means, the name itself is regarded as the function name.

See [Function Call](#) for more details about this topic.

## Function Result and Parameters

---

Usually, function calls are used within Natural statements instead of variables or constant values. Since the compiler strictly requires the layout of the operands involved, it is essential to get the format, length and array structure of a function result. Moreover, if the parameter structure of a function is known, the parameters supplied in a function call can be checked for correctness at compilation time.

There are three options to provide this information

- with a `DEFINE PROTOTYPE` statement;
- implicit by the existent object (cataloged version) of the called function, which is automatically loaded by the compiler if no `DEFINE PROTOTYPE` statement was found before;
- with an explicit `(IR=)` clause specified in the function call.

The simplest way is certainly to use the second option, as it always takes the information from the object which is called at runtime. However, this is only possible if the cataloged object of the called function is available. If a function is called with a variable function call, via a variable containing the function name, the name of the function object is unknown and as a consequence cannot be



identified and loaded. In this case a `DEFINE PROTOTYPE` statement can be used to describe the function interface. The first two options comprise a full validation of the result and the parameters.

If neither a `DEFINE PROTOTYPE` statement nor the existent object of a function call is available, two casting options can be used in a function call. These are

- `(IR=)` to specify the function result format/length/array structure. This option does not incorporate any parameter checks.
- `(PT=)` to use a previously defined prototype with a name other than the function name.

## Explicit Prototype Definition (DEFINE PROTOTYPE)

---

To specify the interface of a certain function, a `DEFINE PROTOTYPE` statement can be used. This statement defines the layout of the parameters, which are to be passed in a function call, and the format/length of the result field returned by the function. Furthermore, it indicates whether a function call is a “**symbolic**” or a “**variable**” function call.

When a function call was found, Natural tries to locate a prototype with the same name as the used function name. If such a prototype is found, the function result and parameter layouts of this prototype are used to resolve the function call. Especially, the decision on the function call mode (“symbolic” or “variable”) is made at this place.

## Implicit (Automatic) Prototype Definition

---

If a function call is resolved in a program, the compiler searches for a `DEFINE PROTOTYPE` statement with the function name, which has been defined before. If such a statement cannot be found, Natural tries to load the called function into the buffer pool. If successful, the function layout of the result and the parameters is extracted from the object data and kept as if it was provided by an explicit `DEFINE PROTOTYPE` statement for this function. This manner of use is denoted as *automatic prototype definition*. It assures great conformity between the interface definition (at compile time) and the passing accuracy at runtime.

## Prototype Cast (PT Clause)

---

In order to get the interface layout of a called function, Natural tries to locate a `DEFINE PROTOTYPE` statement with the same name as the function identifier. If such a statement is not available, and the called function object cannot be loaded (see *Implicit (Automatic) Prototype Definition*), a `(PT=)` clause can be specified in the function call. If such a clause is applied, the `DEFINE PROTOTYPE` statement with the referenced name (which is different from the function name) is used to describe the function result and to validate the parameters.

Example:

```
#I := #MULT(<<(PT=#ADD) 2 , 3>>)
```

In this example, the function `#MULT` is called, but the result and parameter layouts are used from a prototype whose name is `#ADD`.

## Intermediate Result Definition (IR Clause)

---

Usually, the function result is specified by a `DEFINE PROTOTYPE` statement, which is either coded explicitly or will be created automatically with the function object (see *Implicit (Automatic) Prototype Definition*). If such a definition is not available, the result layout can be specified by using the `(IR=)` clause in the function call. If this clause is used, it determines which format/length the compiler should use for the result field in the statement generation. This clause can also be specified if the prototype definition is available for a function call. In this case, the result layout in the prototype is overruled by the `(IR=)` clause specification; the parameter checks, however, are performed according to the prototype definition.

## Combinations of Possible Prototype Definitions

---

In order to resolve a function call, the compiler needs information on

- the function call mode (**symbolic** or **variable**);
- the layout (format/length) of the function result;
- the layout (format/length) of the function parameters.

Different options allow you to provide this data, which are the explicit prototype definition, the implicit prototype definition, the `(PT=)` option, and the `(IR=)` option. But which one has an effect if multiple of these clauses are used?

A function call is used as a **variable** function call if there is a related prototype with the same name, which contains a `VARIABLE` clause. In all other cases, the function call is treated as a **symbolic** function call.

The *result* is determined in the following order:

- the definition provided in `(IR=)`, if this clause is specified;
- the `RETURNS` definition in the prototype referenced in `(PT=)`, if this clause is specified;
- the explicit prototype definition (`DEFINE PROTOTYPE`) with the same name as used in the function call, if it exists;
- the implicit prototype definition, which is loaded automatically from the existing function object.

If none of these options applies, a syntax error is raised.

The *parameter* checks are performed according to the definition in:

- the prototype definition referenced in `(PT=)`, if this clause is specified;
- the explicit prototype definition (`DEFINE PROTOTYPE`) with the same name as used in the function call, if it exists;
- the implicit prototype definition, which is loaded automatically from the existing function object.

If none of these options applies, the parameter validation is not performed. This allows you to supply any number and layout of parameters in the function call, without receiving a syntax error.

### Example with Multiple Definitions in a Function Call

Program:

```
** Example 'FUNCBX01': Declare result value and parameters (Program)
*****
*
DEFINE DATA LOCAL
  1 #PROTO-NAME (A20)
  1 #PARAM1      (I4)
  1 #PARAM2      (I4)
END-DEFINE
*
DEFINE PROTOTYPE VARIABLE #PROTO-NAME
  RETURNS (I4)
  DEFINE DATA PARAMETER
    1 #P1 (I4) BY VALUE OPTIONAL
    1 #P2 (I4) BY VALUE
  END-DEFINE
END-PROTOTYPE
*
#PROTO-NAME := 'F#MULTI'
#PARAM1     := 3
```

```
#PARAM2      := 5
*
WRITE #PROTO-NAME(<#PARAM1, #PARAM2>)
WRITE #PROTO-NAME(<1X ,5>)
*
WRITE F#MULTI(<<(PT=#PROTO-NAME) #PARAM1,#PARAM2>)
*
WRITE F#MULTI(<<(IR=N20) #PARAM1, #PARAM2>)
*
END
```

Function F#MULTI:

```
** Example 'FUNCBX02': Declare result value and parameters (Function)
*****
DEFINE FUNCTION F#MULTI
  RETURNS #RESULT (I4) BY VALUE
  DEFINE DATA PARAMETER
    1 #FACTOR1 (I4) BY VALUE OPTIONAL
    1 #FACTOR2 (I4) BY VALUE
  END-DEFINE
/*
  IF #FACTOR1 SPECIFIED
    #RESULT := #FACTOR1 * #FACTOR2
  ELSE
    #RESULT := #FACTOR2 * 10
  END-IF
/*
END-FUNCTION
*
END ↵
```

## Evaluation Sequence of Functions in Statements

---

Instead of operands, function calls can be used directly in statements. However, this is only allowed with operands which are only *read*, but not *modified* by the statement.

All function calls are evaluated before the statement execution starts. The returned result values are stored in temporary fields and passed to the statement. The functions are executed in the same order in which they appear in the statement. If a function call has parameters which are modified by the function execution, you should consider that this can influence the statement result. This may apply if the same parameter is used at another place in the same statement.

### Example:

Before the COMPUTE statement is started, variable #I has the value 1. In a first step, function F#RETURN is executed. This changes #I to value 2 and returns the same value as the function result. After

this, the COMPUTE operation starts and adds the incremented #I (2) and the temporary field (2) to a sum of 4.

Program:

```
** Example 'FUNCCX01': Parameter changed within function (Program)
*****
DEFINE DATA LOCAL
  1 #I      (I2) INIT <1>
  1 #RESULT (I2)
END-DEFINE
*
COMPUTE #RESULT := #I + F#RETURN(<#I>) /* First evaluate function call,
  /* then execute the addition.
*
WRITE '#I      :' #I /
      '#RESULT:' #RESULT
*
END
```

Function:

```
** Example 'FUNCCX02': Parameter changed within function (Function)
*****
DEFINE FUNCTION F#RETURN
  RETURNS #RESULT (I2) BY VALUE
  DEFINE DATA PARAMETER
    1 #PARAM1 (I2) BY VALUE RESULT
  END-DEFINE
  /*
  #PARAM1 := #PARAM1 + 1      /* Increment parameter.
  #RESULT := #PARAM1         /* Set result value.
  /*
END-FUNCTION
*
END ↵
```

Output of Program FUNCCX01:

```
#I      :      2
#RESULT:      4 ↵
```

## Using a Function as a Statement

---

A function can also be called stand-alone, without being embedded in other statements. In this case, the function return value is completely ignored.

If such an execution mode is desired, only the function call is coded, which then stands for a statement. In order to prevent an unwanted link to the previous statement in the source code, a semicolon must be used to explicitly separate the function call from this statement.

### Example:

#### Program:

```
** Example 'FUNCDX01': Using a function as a statement (Program)
*****
DEFINE DATA LOCAL
  1 #A (I4) INIT <1>
  1 #B (I4) INIT <2>
END-DEFINE
*
*
WRITE 'Write:' #A #B
F#PRINT-ADD(< 2,3 >)      /* Function call belongs to operand list
                          /* immediately preceding it.
*
WRITE // '*****' //
*
WRITE 'Write:' #A #B;     /* Semicolon separates operands and function.
F#PRINT-ADD(< 2,3 >)     /* Function call does not belong to the
                          /* operand list.
*
END
```

#### Function:

```
** Example 'FUNCDX02': Using a function as a statement (Function)
*****
DEFINE FUNCTION F#PRINT-ADD
  RETURNS (I4)
  DEFINE DATA PARAMETER
    1 #SUMMAND1 (I4) BY VALUE
    1 #SUMMAND2 (I4) BY VALUE
  END-DEFINE
  /*
  F#PRINT-ADD := #SUMMAND1 + #SUMMAND2      /* Result of function call.
  WRITE 'Function call:' F#PRINT-ADD
  /*
END-FUNCTION
```

```
*  
END ↵
```

**Output of Program FUNCDX01:**

```
Function call:      5  
Write:           1      2      5  
  
*****  
  
Write:           1      2  
Function call:      5 ↵
```





# V Accessing Data in a Database

---

This part describes various aspects of accessing data in a database with Natural.

[Natural and Database Access](#)

[Accessing Data in an Adabas Database](#)



# 23 Natural and Database Access

---

- Database Management Systems Supported by Natural ..... 206
- Profile Parameters Influencing Database Access ..... 206
- Access through Data Definition Modules ..... 206
- Natural's Data Manipulation Language ..... 207
- Natural's Special SQL Statements ..... 208

This chapter gives an overview of the facilities that Natural provides for accessing different types of database management systems.

## Database Management Systems Supported by Natural

---

Natural offers specific database interfaces for the following types of database management systems (DBMS):

- Nested-relational DBMS (Adabas)

The following topics are covered below:

- [Adabas](#)

### Adabas

Via its integrated Adabas interface, Natural can access Adabas databases either on a local machine or on remote computers. For remote access, an additional routing and communication software such as Entire Net-Work is necessary. In any case, the type of host machine running the Adabas database is transparent for the Natural user.

## Profile Parameters Influencing Database Access

---

There are various Natural profile parameters to define how Natural handles the access to databases.

For a detailed parameter description, refer to the corresponding section in the *Parameter Reference*.

## Access through Data Definition Modules

---

To enable convenient and transparent access to the different database management systems, a special object, the “data definition module” (DDM), is used in Natural. This DDM establishes the connection between the Natural data structures and the data structures in the database system to be used. Such a database structure might be a table in an SQL database, a file in an Adabas database. Hence, the DDM hides the real structure of the database accessed from the Natural application. DDMs are created using the Natural DDM editor.

Natural is capable of accessing multiple types of databases from within a single application by using references to DDMs that represent the specific data structures in the specific database system. The diagram below shows an application that connects to different types of database.

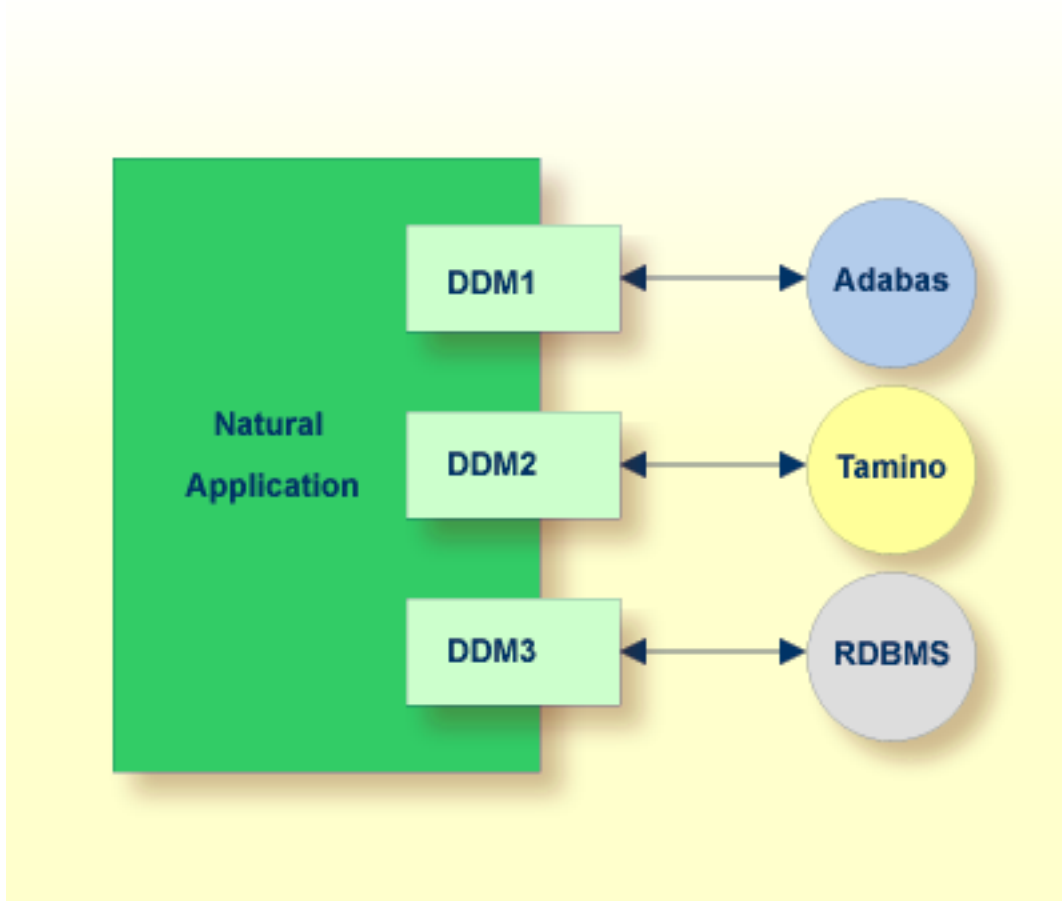

## Natural's Data Manipulation Language

Natural has a built-in data manipulation language (DML) that allows Natural applications to access all database systems supported by Natural using the same language statements such as `FIND`, `READ`, `STORE` or `DELETE`. These statements can be used in a Natural application without knowing the type of database that is going to be accessed.

Natural determines the real type of database system from its configuration files and translates the DML statements into database-specific commands; that is, it generates direct commands for Adabas, SQL statement strings and host variable structures for SQL databases.

Because some of the Natural DML statements provide functionality that cannot be supported for all database types, the use of this functionality is restricted to specific database systems. Please, note the corresponding database-specific considerations in the statements documentation.

## Natural's Special SQL Statements

---

In addition to the “normal” Natural DML statements, Natural provides a set of SQL statements for a more specific use in conjunction with SQL database systems; see *SQL Statements Overview* (in the *Statements* documentation).

Flexible SQL and facilities for working with stored procedures complete the set of SQL commands. These statements can be used for SQL database access only and are not valid for Adabas or other non-SQL-databases.

# 24 Accessing Data in an Adabas Database

---

- Adabas Database Management Interfaces ADA and ADA2 ..... 210
- Data Definition Modules - DDMs ..... 210
- Database Arrays ..... 212
- Defining a Database View ..... 217
- Statements for Database Access ..... 220
- Multi-Fetch Clause ..... 232
- Database Processing Loops ..... 233
- Database Update - Transaction Processing ..... 239
- Selecting Records Using ACCEPT/REJECT ..... 246
- AT START/END OF DATA Statements ..... 250
- Unicode Data ..... 252

This chapter describes various aspects of accessing data in an Adabas database with Natural.

## Adabas Database Management Interfaces ADA and ADA2

---

Natural's Adabas database management interfaces ADA and ADA2 are considered distinct database interfaces like, for example, ADA and SQL.

Database type ADA is Natural's default interface to Adabas databases. It is the appropriate choice if new Adabas functionality as introduced with Adabas Version 6 on Open Systems and Adabas Version 8 on mainframes is not concerned.

Database type ADA2 is provided as an extended interface to Adabas databases as of Version 6 on Open Systems and Adabas as of Version 8 on mainframes. In particular, it supports Adabas LA fields, Adabas large object fields and extended Adabas buffer lengths. The support of Adabas LA and large object fields implies the use of Natural format (A) `DYNAMIC` in a view definition, the support of extended Adabas buffer lengths enables the definition of view sizes that exceed 64 KB. For further information, refer to *Defining a Database View*.

Database type ADA2 does not support **multi-fetch processing**. Corresponding global and local definitions are ignored at runtime.

Software AG products which have their own system files require a corresponding physical database of database type ADA.

Natural objects that were compiled with database type ADA can be executed in an environment where the corresponding Adabas database is defined as database type ADA2.

## Data Definition Modules - DDMs

---

For Natural to be able to access a database file, a logical definition of the physical database file is required. Such a logical file definition is called a data definition module (DDM).

This section covers the following topics:



- Use of Data Definition Modules

### Use of Data Definition Modules

The data definition module contains information about the individual fields of the file - information which is relevant for the use of these fields in a Natural program. A DDM constitutes a logical view of a physical database file.

For each physical file of a database, one or more DDMs can be defined. And for each DDM one or more data views can be defined as described *View Definition* in the `DEFINE DATA` statement documentation and explained in the section *Defining a Database View*.

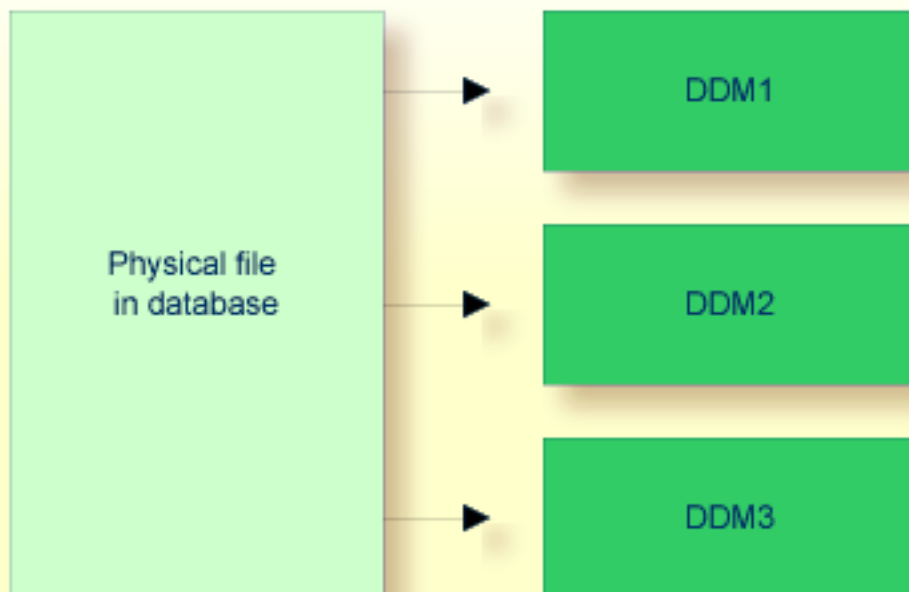

DDMs are defined by the Natural administrator with Predict (or, if Predict is not available, with the corresponding Natural function).

## Database Arrays

---

Adabas supports array structures within the database in the form of multiple-value fields and periodic groups.

This section covers the following topics:

- [Multiple-Value Fields](#)
- [Periodic Groups](#)
- [Referencing Multiple-Value Fields and Periodic Groups](#)
- [Multiple-Value Fields within Periodic Groups](#)
- [Referencing Multiple-Value Fields within Periodic Groups](#)
- [Referencing the Internal Count of a Database Array](#)

### Multiple-Value Fields

A multiple-value field is a field which can have more than one value (up to 65534, depending on the Adabas version and definition of the FDT) within a given record.

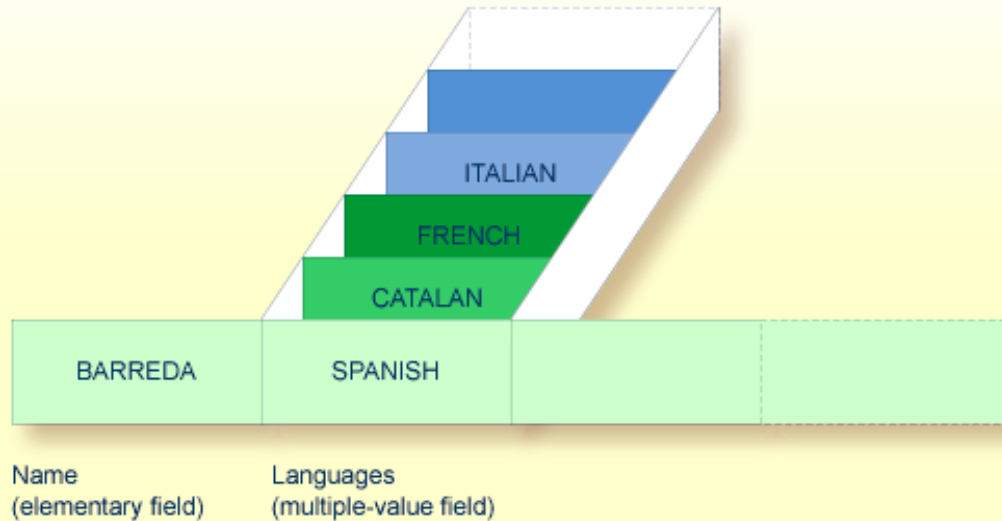
**Example:**

Assuming that the above is a record in an employees file, the first field (Name) is an elementary field, which can contain only one value, namely the name of the person; whereas the second field (Languages), which contains the languages spoken by the person, is a multiple-value field, as a person can speak more than one language.

**Periodic Groups**

A periodic group is a group of fields (which may be elementary fields and/or multiple-value fields) that may have more than one occurrence (up to 65534, depending on the Adabas version and definition of the field definition table (FDT)) within a given record.

The different values of a multiple-value field are usually called "occurrences"; that is, the number of occurrences is the number of values which the field contains, and a specific occurrence means a specific value. Similarly, in the case of periodic groups, occurrences refer to a group of values.

**Example:**

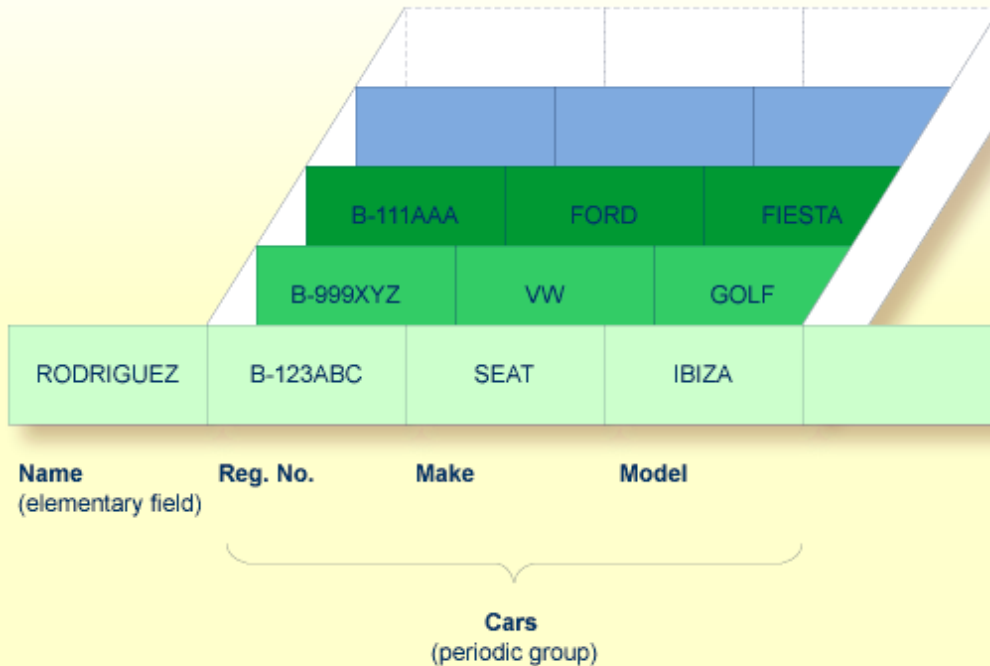

Assuming that the above is a record in a vehicles file, the first field (Name) is an elementary field which contains the name of a person; Cars is a periodic group which contains the automobiles owned by that person. The periodic group consists of three fields which contain the registration number, make and model of each automobile. Each occurrence of Cars contains the values for one automobile.

**Referencing Multiple-Value Fields and Periodic Groups**

To reference one or more occurrences of a multiple-value field or a periodic group, you specify an “index notation” after the field name.

**Examples:**

The following examples use the multiple-value field `LANGUAGES` and the periodic group `CARS` from the previous examples.

The various values of the multiple-value field `LANGUAGES` can be referenced as follows.

| Example          | Explanation                                                                |
|------------------|----------------------------------------------------------------------------|
| LANGUAGES (1)    | References the first value (SPANISH).                                      |
| LANGUAGES (X)    | The value of the variable X determines the value to be referenced.         |
| LANGUAGES (1:3)  | References the first three values (SPANISH, CATALAN and FRENCH).           |
| LANGUAGES (6:10) | References the sixth to tenth values.                                      |
| LANGUAGES (X:Y)  | The values of the variables X and Y determine the values to be referenced. |

The various occurrences of the periodic group CARS can be referenced in the same manner:

| Example    | Explanation                                                                      |
|------------|----------------------------------------------------------------------------------|
| CARS (1)   | References the first occurrence (B-123ABC/SEAT/IBIZA).                           |
| CARS (X)   | The value of the variable X determines the occurrence to be referenced.          |
| CARS (1:2) | References the first two occurrences (B-123ABC/SEAT/IBIZA and B-999XYZ/VW/GOLF). |
| CARS (4:7) | References the fourth to seventh occurrences.                                    |
| CARS (X:Y) | The values of the variables X and Y determine the occurrences to be referenced.  |

### Multiple-Value Fields within Periodic Groups

An Adabas array can have up to two dimensions: a multiple-value field within a periodic group.

**Example:**

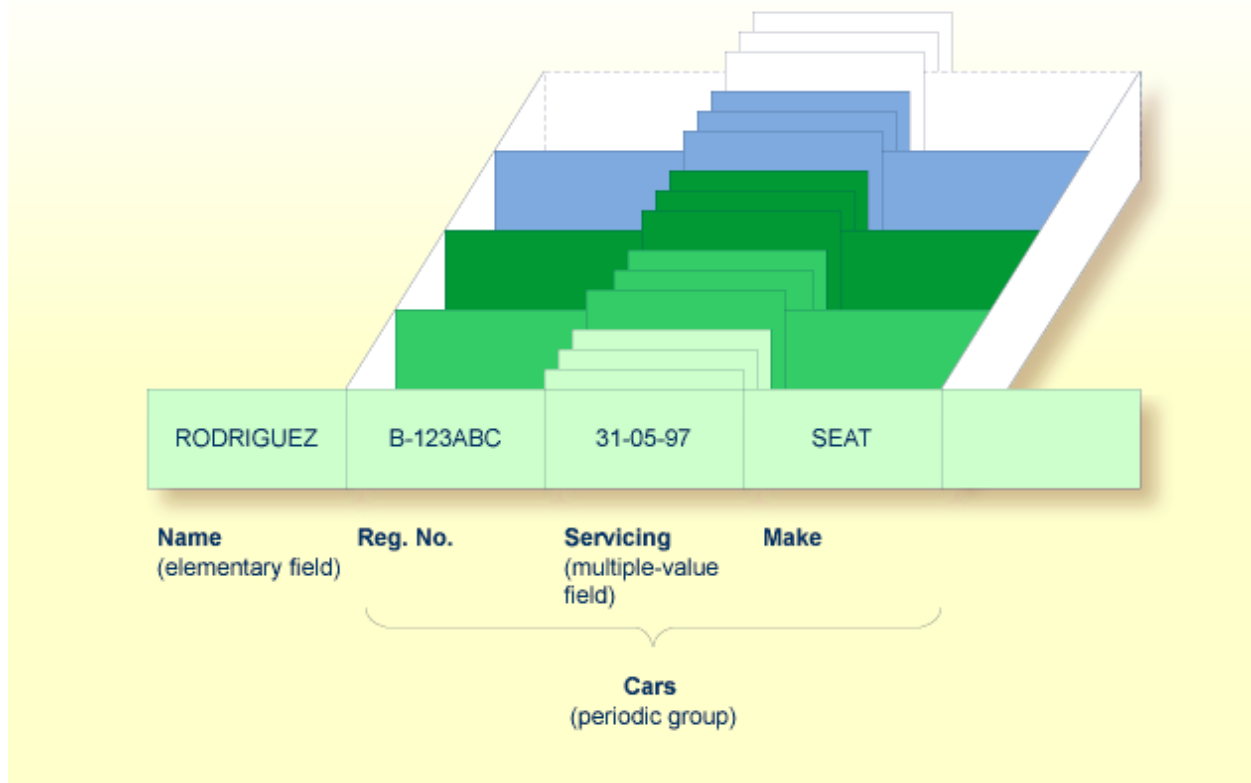

Assuming that the above is a record in a vehicles file, the first field (Name) is an elementary field which contains the name of a person; Cars is a periodic group, which contains the automobiles owned by that person. This periodic group consists of three fields which contain the registration number, servicing dates and make of each automobile. Within the periodic group Cars, the field Servicing is a multiple-value field, containing the different servicing dates for each automobile.

**Referencing Multiple-Value Fields within Periodic Groups**

To reference one or more occurrences of a multiple-value field within a periodic group, you specify a “two-dimensional” index notation after the field name.

**Examples:**

The following examples use the multiple-value field `SERVICING` within the periodic group `CARS` from the example above. The various values of the multiple-value field can be referenced as follows:

| Example              | Explanation                                                                         |
|----------------------|-------------------------------------------------------------------------------------|
| SERVICING (1,1)      | References the first value of SERVICING in the first occurrence of CARS (31-05-97). |
| SERVICING (1:5,1)    | References the first value of SERVICING in the first five occurrences of CARS.      |
| SERVICING (1:5,1:10) | References the first ten values of SERVICING in the first five occurrences of CARS. |

### Referencing the Internal Count of a Database Array

It is sometimes necessary to reference a multiple-value field or a periodic group without knowing how many values/occurrences exist in a given record. Adabas maintains an internal count of the number of values in each multiple-value field and the number of occurrences of each periodic group. This count may be read in a READ statement by specifying C\* immediately before the field name.

The count is returned in format/length N3. See [Referencing the Internal Count for a Database Array](#) for further details.

| Example         | Explanation                                                                                                                                                                                 |
|-----------------|---------------------------------------------------------------------------------------------------------------------------------------------------------------------------------------------|
| C*LANGUAGES     | Returns the number of values of the multiple-value field LANGUAGES.                                                                                                                         |
| C*CARS          | Returns the number of occurrences of the periodic group CARS.                                                                                                                               |
| C*SERVICING (1) | Returns the number of values of the multiple-value field SERVICING in the first occurrence of a periodic group (assuming that SERVICING is a multiple-value field within a periodic group.) |

## Defining a Database View

To be able to use database fields in a Natural program, you must specify the fields in a database view.

In the view, you specify the name of the data definition module (see [Data Definition Modules - DDMs](#)) from which the fields are to be taken, and the names of the **database fields** themselves (that is, their long names, not their database-internal short names).

The view may comprise an entire DDM or only a subset of it. The order of the fields in the view need not be the same as in the underlying DDM.

As described in the section [Statements for Database Access](#), the view name is used in the statements READ, FIND, HISTOGRAM to determine which database is to be accessed.

For further information on the complete syntax of the view definition option or on the definition/re-definition of a group of fields, see [View Definition](#) in the description of the DEFINE DATA statement in the *Statements* documentation.

Basically, you have the following options to define a database view:

■ **Inside the Program**

You can define a database view inside the program, that is, directly within the `DEFINE DATA` statement of the program.

■ **Outside the Program**

You can define a database view outside the program, that is, in a separate programming object: either a local data area (LDA) or a global data area (GDA), with the `DEFINE DATA` statement of the program referencing that data area.

▶ **To define a database view inside the program**

- 1 At Level 1, specify the view name as follows:

```
1 view-name VIEW OF ddm-name
```

where *view-name* is the name you choose for the view, *ddm-name* is the name of the DDM from which the fields specified in the view are taken.

- 2 At Level 2, specify the names of the database fields from the DDM.

In the illustration below, the name of the view is `ABC`, and it comprises the fields `NAME`, `FIRST-NAME` and `PERSONNEL-ID` from the DDM `XYZ`.

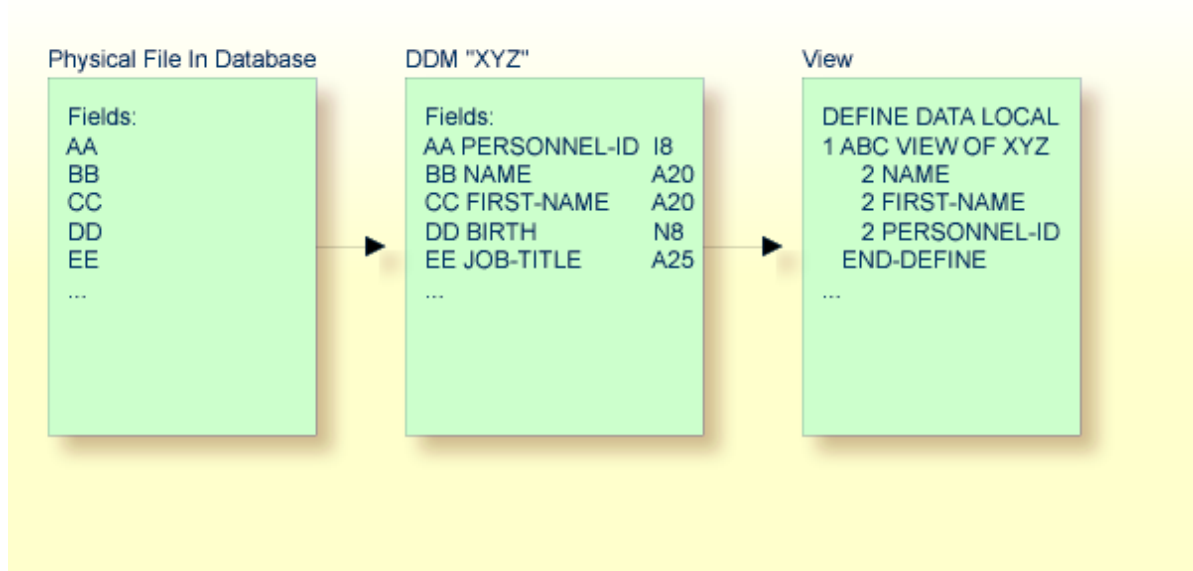

In the view, the format and length of a database field need not be specified, as these are already defined in the underlying DDM.

Sample Program:



In this example, the *view-name* is VIEWEMP, and the *ddm-name* is EMPLOYEES, and the names of the database fields taken from the DDM are NAME, FIRST-NAME and PERSONNEL-ID.

```
DEFINE DATA LOCAL
1 VIEWEMP VIEW OF EMPLOYEES
  2 NAME
  2 FIRST-NAME
  2 PERSONNEL-ID
1 #VARI-A (A20)
1 #VARI-B (N3.2)
1 #VARI-C (I4)
END-DEFINE
...
```

► To define a database view outside the program

- 1 In the program, specify:

```
DEFINE DATA LOCAL
      USING <data-area-name>
END-DEFINE
...
```

where *data-area-name* is the name you choose for the local or global data area, for example, LDA39.

- 2 In the data area to be referenced:
  1. At Level 1 in the Name column, specify the name you choose for the view, and in the Miscellaneous column, the name of the DDM from which the fields specified in the view are taken.
  2. At Level 2, specify the names of the database fields from the DDM.

Example LDA39:

In this example, the view name is VIEWEMP, the DDM name is EMPLOYEES, and the names of the database fields taken from the DDM are PERSONNEL-ID, FIRST-NAME and NAME.

| I | T | L | Name         | F | Length | Miscellaneous |
|---|---|---|--------------|---|--------|---------------|
| A | 1 | 1 | VIEWEMP      |   |        | EMPLOYEES     |
|   | 2 |   | PERSONNEL-ID | A | 8      |               |
|   | 2 |   | FIRST-NAME   | A | 20     |               |
|   | 2 |   | NAME         | A | 20     |               |

|   |         |   |     |   |
|---|---------|---|-----|---|
| 1 | #VARI-A | A | 20  | ↔ |
| 1 | #VARI-B | N | 3.2 | ↔ |
| 1 | #VARI-C | I | 4   | ↔ |

### Considerations Concerning Databases of Type ADA2

With databases of type ADA2, the following applies:

- If large alphanumeric (LA) or large object (LOB) fields (Adabas LA/LB option) are to be used, these fields can be specified within the view definition with both fixed format/length, for example, A20 or U20, and dynamic format/length, for example, (A)DYNAMIC or U(DYNAMIC).
- Length indicator fields L@. . . can also be specified within views if they are related to LA or LOB fields.

### Statements for Database Access

---

To read data from a database, the following statements are available:

| Statement | Meaning                                                                                                                 |
|-----------|-------------------------------------------------------------------------------------------------------------------------|
| READ      | Select a range of records from a database in a specified sequence.                                                      |
| FIND      | Select from a database those records which meet a specified search criterion.                                           |
| HISTOGRAM | Read only the values of one database field, or determine the number of records which meet a specified search criterion. |

#### READ Statement

The following topics are covered:

- Use of READ Statement
- Basic Syntax of READ Statement
- Example of READ Statement
- Limiting the Number of Records to be Read
- STARTING/ENDING Clauses
- WHERE Clause

- Further Example of READ Statement

### Use of READ Statement

The READ statement is used to read records from a database. The records can be retrieved from the database

- in the order in which they are physically stored in the database (READ IN PHYSICAL SEQUENCE), or
- in the order of Adabas Internal Sequence Numbers (READ BY ISN), or
- in the order of the values of a descriptor field (READ IN LOGICAL SEQUENCE).

In this document, only READ IN LOGICAL SEQUENCE is discussed, as it is the most frequently used form of the READ statement.

For information on the other two options, please refer to the description of the READ statement in the *Statements* documentation.

### Basic Syntax of READ Statement

The basic syntax of the READ statement is:

```
READ view IN LOGICAL SEQUENCE BY descriptor
```

or shorter:

```
READ view LOGICAL BY descriptor
```

- where

|                   |                                                                                                                                                     |
|-------------------|-----------------------------------------------------------------------------------------------------------------------------------------------------|
| <i>view</i>       | is the name of a view defined in the DEFINE DATA statement and as explained in <a href="#">Defining a Database View</a> .                           |
| <i>descriptor</i> | is the name of a database field defined in that view. The values of this field determine the order in which the records are read from the database. |

If you specify a descriptor, you need not specify the **keyword** LOGICAL:

```
READ view BY descriptor
```

If you do not specify a descriptor, the records will be read in the order of values of the field defined as default descriptor (under Default Sequence) in the **DDM**. However, if you specify no descriptor, you must specify the **keyword** LOGICAL:

READ *view* LOGICAL

**Example of READ Statement**

```

** Example 'READX01': READ
*****
DEFINE DATA LOCAL
1 MYVIEW VIEW OF EMPLOYEES
  2 NAME
  2 PERSONNEL-ID
  2 JOB-TITLE
END-DEFINE
*
READ (6) MYVIEW BY NAME
  DISPLAY NAME PERSONNEL-ID JOB-TITLE
END-READ
END
    
```

**Output of Program READX01:**

With the READ statement in this example, records from the EMPLOYEES file are read in alphabetical order of their last names.

The program will produce the following output, displaying the information of each employee in alphabetical order of the employees' last names.

|       |          |                 |                         |
|-------|----------|-----------------|-------------------------|
| Page  | 1        |                 | 04-11-11 14:15:54       |
|       | NAME     | PERSONNEL<br>ID | CURRENT<br>POSITION     |
| ----- |          |                 |                         |
|       | ABELLAN  | 60008339        | MAQUINISTA              |
|       | ACHIESON | 30000231        | DATA BASE ADMINISTRATOR |
|       | ADAM     | 50005800        | CHEF DE SERVICE         |
|       | ADKINSON | 20008800        | PROGRAMMER              |
|       | ADKINSON | 20009800        | DBA                     |
|       | ADKINSON | 2001100         |                         |

If you wanted to read the records to create a report with the employees listed in sequential order by date of birth, the appropriate READ statement would be:

```
READ MYVIEW BY BIRTH
```

You can only specify a field which is defined as a “descriptor” in the underlying **DDM** (it can also be a subdescriptor, superdescriptor, hyperdescriptor or phonetic descriptor or a non-descriptor).

### Limiting the Number of Records to be Read

As shown in the previous example program, you can limit the number of records to be read by specifying a number in parentheses after the keyword `READ`:

```
READ (6) MYVIEW BY NAME
```

In that example, the `READ` statement would read no more than 6 records.

Without the limit notation, the above `READ` statement would read *all* records from the `EMPLOYEES` file in the order of last names from A to Z.

### STARTING/ENDING Clauses

The `READ` statement also allows you to qualify the selection of records based on the *value* of a descriptor field. With an `EQUAL TO/STARTING FROM` option in the `BY` clause, you can specify the value at which reading should begin. (Instead of using the keyword `BY`, you may specify the keyword `WITH`, which would have the same effect). By adding a `THRU/ENDING AT` option, you can also specify the value in the logical sequence at which reading should end.

For example, if you wanted a list of those employees in the order of job titles starting with `TRAINEE` and continuing on to Z, you would use one of the following statements:

```
READ MYVIEW WITH JOB-TITLE = 'TRAINEE'
READ MYVIEW WITH JOB-TITLE STARTING FROM 'TRAINEE'
READ MYVIEW BY JOB-TITLE = 'TRAINEE'
READ MYVIEW BY JOB-TITLE STARTING FROM 'TRAINEE'
```

Note that the value to the right of the equal sign (=) or `STARTING FROM` option must be enclosed in apostrophes. If the value is numeric, this **text notation** is not required.

The sequence of records to be read can be even more closely specified by adding an end limit with a `THRU/ENDING AT` clause.

To read just the records with the job title `TRAINEE`, you would specify:

```
READ MYVIEW BY JOB-TITLE STARTING FROM 'TRAINEE' THRU 'TRAINEE'  
READ MYVIEW WITH JOB-TITLE EQUAL TO 'TRAINEE'  
                        ENDING AT 'TRAINEE'
```

To read just the records with job titles that begin with A or B, you would specify:

```
READ MYVIEW BY JOB-TITLE = 'A' THRU 'C'  
READ MYVIEW WITH JOB-TITLE STARTING FROM 'A' ENDING AT 'C'
```

The values are read up to and including the value specified after THRU/ENDING AT. In the two examples above, all records with job titles that begin with A or B are read; if there were a job title C, this would also be read, but not the next higher value CA.

### WHERE Clause

The WHERE clause may be used to further qualify which records are to be read.

For instance, if you wanted only those employees with job titles starting from TRAINEE who are paid in US currency, you would specify:

```
READ MYVIEW WITH JOB-TITLE = 'TRAINEE'  
                WHERE CURR-CODE = 'USD'
```

The WHERE clause can also be used with the BY clause as follows:

```
READ MYVIEW BY NAME  
                WHERE SALARY = 20000
```

The WHERE clause differs from the BY clause in two respects:

- The field specified in the WHERE clause need not be a descriptor.
- The expression following the WHERE option is a logical condition.

The following logical operators are possible in a WHERE clause:

|                          |    |    |
|--------------------------|----|----|
| EQUAL                    | EQ | =  |
| NOT EQUAL TO             | NE | ≠  |
| LESS THAN                | LT | <  |
| LESS THAN OR EQUAL TO    | LE | <= |
| GREATER THAN             | GT | >  |
| GREATER THAN OR EQUAL TO | GE | >= |

The following program illustrates the use of the STARTING FROM, ENDING AT and WHERE clauses:

```

** Example 'READX02': READ (with STARTING, ENDING and WHERE clause)
*****
DEFINE DATA LOCAL
1 MYVIEW VIEW OF EMPLOYEES
  2 NAME
  2 JOB-TITLE
  2 INCOME      (1:2)
    3 CURR-CODE
    3 SALARY
    3 BONUS      (1:1)
END-DEFINE
*
READ (3) MYVIEW WITH  JOB-TITLE
STARTING FROM 'TRAINEE' ENDING AT 'TRAINEE'
          WHERE CURR-CODE (*) = 'USD'
  DISPLAY NOTITLE NAME / JOB-TITLE 5X INCOME (1:2)
  SKIP 1
END-READ
END

```

**Output of Program READX02:**

| NAME<br>CURRENT<br>POSITION | INCOME           |                  |       |
|-----------------------------|------------------|------------------|-------|
|                             | CURRENCY<br>CODE | ANNUAL<br>SALARY | BONUS |
| SENKO                       | USD              | 23000            | 0     |
| TRAINEE                     | USD              | 21800            | 0     |
| BANGART                     | USD              | 25000            | 0     |
| TRAINEE                     | USD              | 23000            | 0     |
| LINCOLN                     | USD              | 24000            | 0     |
| TRAINEE                     | USD              | 22000            | 0     |

**Further Example of READ Statement**

See the following example program:

- [READX03 - READ statement](#)

## FIND Statement

The following topics are covered:

- Use of FIND Statement
- Basic Syntax of FIND Statement
- Limiting the Number of Records to be Processed
- WHERE Clause
- Example of FIND Statement with WHERE Clause
- IF NO RECORDS FOUND Condition
- Further Examples of FIND Statement

### Use of FIND Statement

The `FIND` statement is used to select from a database those records which meet a specified search criterion.

### Basic Syntax of FIND Statement

The basic syntax of the `FIND` statement is:

```
FIND RECORDS IN view WITH field = value
```

or shorter:

```
FIND view WITH field = value
```

- where

|              |                                                                                                                                           |
|--------------|-------------------------------------------------------------------------------------------------------------------------------------------|
| <i>view</i>  | is the name of a view as defined in the <code>DEFINE DATA</code> statement and as explained in <a href="#">Defining a Database View</a> . |
| <i>field</i> | is the name of a database field as defined in that view.                                                                                  |

You can only specify a *field* which is defined as a “descriptor” in the underlying **DDM** (it can also be a subdescriptor, superdescriptor, hyperdescriptor or phonetic descriptor).

For the complete syntax, refer to the `FIND` statement documentation.



## Limiting the Number of Records to be Processed

In the same way as with the `READ` statement described [above](#), you can limit the number of records to be processed by specifying a number in parentheses after the keyword `FIND`:

```
FIND (6) RECORDS IN MYVIEW WITH NAME = 'CLEGG'
```

In the above example, only the first 6 records that meet the search criterion would be processed.

Without the limit notation, all records that meet the search criterion would be processed.



**Note:** If the `FIND` statement contains a `WHERE` clause (see below), records which are rejected as a result of the `WHERE` clause are *not* counted against the limit.

## WHERE Clause

With the `WHERE` clause of the `FIND` statement, you can specify an additional selection criterion which is evaluated *after* a record (selected with the `WITH` clause) has been read and *before* any processing is performed on the record.

## Example of FIND Statement with WHERE Clause

```
** Example 'FINDX01': FIND (with WHERE)
*****
DEFINE DATA LOCAL
1 MYVIEW VIEW OF EMPLOYEES
  2 PERSONNEL-ID
  2 NAME
  2 JOB-TITLE
  2 CITY
END-DEFINE
*
FIND MYVIEW WITH CITY = 'PARIS'
          WHERE JOB-TITLE = 'INGENIEUR COMMERCIAL'
  DISPLAY NOTITLE CITY JOB-TITLE PERSONNEL-ID NAME
END-FIND
END
```



**Note:** In this example only those records which meet the criteria of the `WITH` clause *and* the `WHERE` clause are processed in the `DISPLAY` statement.

Output of Program `FINDX01`:

| CITY  | CURRENT POSITION     | PERSONNEL ID | NAME             |
|-------|----------------------|--------------|------------------|
| PARIS | INGENIEUR COMMERCIAL | 50007300     | CAHN             |
| PARIS | INGENIEUR COMMERCIAL | 50006500     | MAZUY            |
| PARIS | INGENIEUR COMMERCIAL | 50004700     | FAURIE           |
| PARIS | INGENIEUR COMMERCIAL | 50004400     | VALLY            |
| PARIS | INGENIEUR COMMERCIAL | 50002800     | BRETON           |
| PARIS | INGENIEUR COMMERCIAL | 50001000     | GIGLEUX          |
| PARIS | INGENIEUR COMMERCIAL | 50000400     | KORAB-BRZOZOWSKI |

**IF NO RECORDS FOUND Condition**

If no records are found that meet the search criteria specified in the WITH and WHERE clauses, the statements within the FIND processing loop are not executed (for the previous example, this would mean that the DISPLAY statement would not be executed and consequently no employee data would be displayed).

However, the FIND statement also provides an IF NO RECORDS FOUND clause, which allows you to specify processing you wish to be performed in the case that no records meet the search criteria.

Example:

```

** Example 'FINDX02': FIND (with IF NO RECORDS FOUND)
*****
DEFINE DATA LOCAL
1 MYVIEW VIEW OF EMPLOYEES
  2 NAME
  2 FIRST-NAME
END-DEFINE
*
FIND MYVIEW WITH NAME = 'BLACKSMITH'
  IF NO RECORDS FOUND
    WRITE 'NO PERSON FOUND.'
  END-NOREC
  DISPLAY NAME FIRST-NAME
END-FIND
END
    
```

The above program selects all records in which the field NAME contains the value BLACKSMITH. For each selected record, the name and first name are displayed. If no record with NAME = 'BLACKSMITH' is found on the file, the WRITE statement within the IF NO RECORDS FOUND clause is executed.

Output of Program FINDX02:

```
Page      1                                04-11-11  14:15:54
      NAME      FIRST-NAME
-----
NO PERSON FOUND.
```

### Further Examples of FIND Statement

See the following example programs:

- *FINDX07 - FIND (with several clauses)*
- *FINDX08 - FIND (with LIMIT)*
- *FINDX09 - FIND (using \*NUMBER, \*COUNTER, \*ISN)*
- *FINDX10 - FIND (combined with READ)*
- *FINDX11 - FIND NUMBER (with \*NUMBER)*

### HISTOGRAM Statement

The following topics are covered:

- Use of HISTOGRAM Statement
- Syntax of HISTOGRAM Statement
- Limiting the Number of Values to be Read
- STARTING/ENDING Clauses
- WHERE Clause
- Example of HISTOGRAM Statement

### Use of HISTOGRAM Statement

The HISTOGRAM statement is used to either read only the values of one database field, or determine the number of records which meet a specified search criterion.

The HISTOGRAM statement does not provide access to any database fields other than the one specified in the HISTOGRAM statement.

### Syntax of HISTOGRAM Statement

The basic syntax of the HISTOGRAM statement is:

```
HISTOGRAM VALUE IN view FOR field
```

or shorter:

```
HISTOGRAM view FOR field
```

- where

|              |                                                                                                                              |
|--------------|------------------------------------------------------------------------------------------------------------------------------|
| <i>view</i>  | is the name of a view as defined in the DEFINE DATA statement and as explained in <a href="#">Defining a Database View</a> . |
| <i>field</i> | is the name of a database field as defined in that view.                                                                     |

For the complete syntax, refer to the HISTOGRAM statement documentation.

### Limiting the Number of Values to be Read

In the same way as with the READ statement, you can limit the number of values to be read by specifying a number in parentheses after the keyword HISTOGRAM:

```
HISTOGRAM (6) MYVIEW FOR NAME
```

In the above example, only the first 6 values of the field NAME would be read.

Without the limit notation, all values would be read.

### STARTING/ENDING Clauses

Like the READ statement, the HISTOGRAM statement also provides a STARTING FROM clause and an ENDING AT (or THRU) clause to narrow down the range of values to be read by specifying a starting value and ending value.

### Examples:

```
HISTOGRAM MYVIEW FOR NAME STARTING from 'BOUCHARD'
HISTOGRAM MYVIEW FOR NAME STARTING from 'BOUCHARD' ENDING AT 'LANIER'
HISTOGRAM MYVIEW FOR NAME from 'BLOOM' THRU 'ROESER'
```

**WHERE Clause**

The HISTOGRAM statement also provides a WHERE clause which may be used to specify an additional selection criterion that is evaluated *after* a value has been read and *before* any processing is performed on the value. The field specified in the WHERE clause must be the same as in the main clause of the HISTOGRAM statement.

**Example of HISTOGRAM Statement**

```

** Example 'HISTOX01': HISTOGRAM
*****
DEFINE DATA LOCAL
1 MYVIEW VIEW OF EMPLOYEES
  2 CITY
END-DEFINE
*
LIMIT 8
HISTOGRAM MYVIEW CITY STARTING FROM 'M'
  DISPLAY NOTITLE CITY 'NUMBER OF/PERSONS' *NUMBER *COUNTER
END-HISTOGRAM
END
    
```

In this program, the system variables \*NUMBER and \*COUNTER are also evaluated by the HISTOGRAM statement, and output with the DISPLAY statement. \*NUMBER contains the number of database records that contain the last value read; \*COUNTER contains the total number of values which have been read.

**Output of Program HISTOX01:**

| CITY           | NUMBER OF PERSONS | CNT |
|----------------|-------------------|-----|
| MADISON        | 3                 | 1   |
| MADRID         | 41                | 2   |
| MAILLY LE CAMP | 1                 | 3   |
| MAMERS         | 1                 | 4   |
| MANSFIELD      | 4                 | 5   |
| MARSEILLE      | 2                 | 6   |
| MATLOCK        | 1                 | 7   |
| MELBOURNE      | 2                 | 8   |

## Multi-Fetch Clause

---

This section covers the multi-fetch record retrieval functionality for Adabas databases.

The multi-fetch functionality described in this section is only supported for databases of type ADA. With database type ADA2, the multi-fetch clause is not supported.

The following topics are covered:

- [Purpose of Multi-Fetch Feature](#)
- [Statements Supported](#)
- [Considerations for Multi-Fetch Usage](#)

### Purpose of Multi-Fetch Feature

In standard mode, Natural does not read multiple records with a single database call; it always operates in a one-record-per-fetch mode. This kind of operation is solid and stable, but can take some time if a large number of database records are being processed. To improve the performance of those programs, you can use multi-fetch processing.

By default, Natural uses single-fetch to retrieve data from Adabas databases. This default can be configured using the Natural profile parameter MFSET.

Values ON (multi-fetch) and OFF (single-fetch) define the default behavior. If MFSET is set to NEVER, Natural always uses single-fetch mode and ignores any settings at statement level.

The default processing mode can also be overridden at statement level.

### Statements Supported

Multi-fetch processing is supported for the following statements that do not involve database modification:

- FIND
- READ
- HISTOGRAM

For more information on the syntax, see the description of the MULTI-FETCH clause of the FIND, READ or HISTOGRAM statements.

## Considerations for Multi-Fetch Usage

If nested database loops that refer to the same Adabas file contain `UPDATE` statements in one of the inner loops, Natural continues processing the outer loops with the updated values. This implies in multi-fetch mode, that an outer logical `READ` loop has to be repositioned if an inner database loop updates the value of the descriptor that is used for sequence control in the outer loop. If this attempt leads to a conflict for the current descriptor, an error is returned. To avoid this situation, we recommend that you disable multi-fetch in the outer database loops.

In general, multi-fetch mode improves performance when accessing Adabas databases. In some cases, however, it might be advantageous to use single-fetch to enhance performance, especially if database modifications are involved.

## Database Processing Loops

This section discusses processing loops required to process data that have been selected from a database as a result of a `FIND`, `READ` or `HISTOGRAM` statement.

The following topics are covered:

- [Creation of Database Processing Loops](#)
- [Hierarchies of Processing Loops](#)
- [Example of Nested FIND Loops Accessing the Same File](#)
- [Further Examples of Nested READ and FIND Statements](#)

### Creation of Database Processing Loops

Natural automatically creates the necessary processing loops which are required to process data that have been selected from a database as a result of a `FIND`, `READ` or `HISTOGRAM` statement.

#### Example:

In the following example, the `FIND` loop selects all records from the `EMPLOYEES` file in which the field `NAME` contains the value `ADKINSON` and processes the selected records. In this example, the processing consists of displaying certain fields from each record selected.

```
** Example 'FINDX03': FIND
*****
DEFINE DATA LOCAL
1 MYVIEW VIEW OF EMPLOYEES
  2 NAME
  2 FIRST-NAME
  2 CITY
END-DEFINE
*
```

```
FIND MYVIEW WITH NAME = 'ADKINSON'  
  DISPLAY NAME FIRST-NAME CITY  
END-FIND  
END
```

If the `FIND` statement contained a `WHERE` clause in addition to the `WITH` clause, only those records that were selected as a result of the `WITH` clause *and* met the `WHERE` criteria would be processed.

The following diagram illustrates the flow logic of a database processing loop:



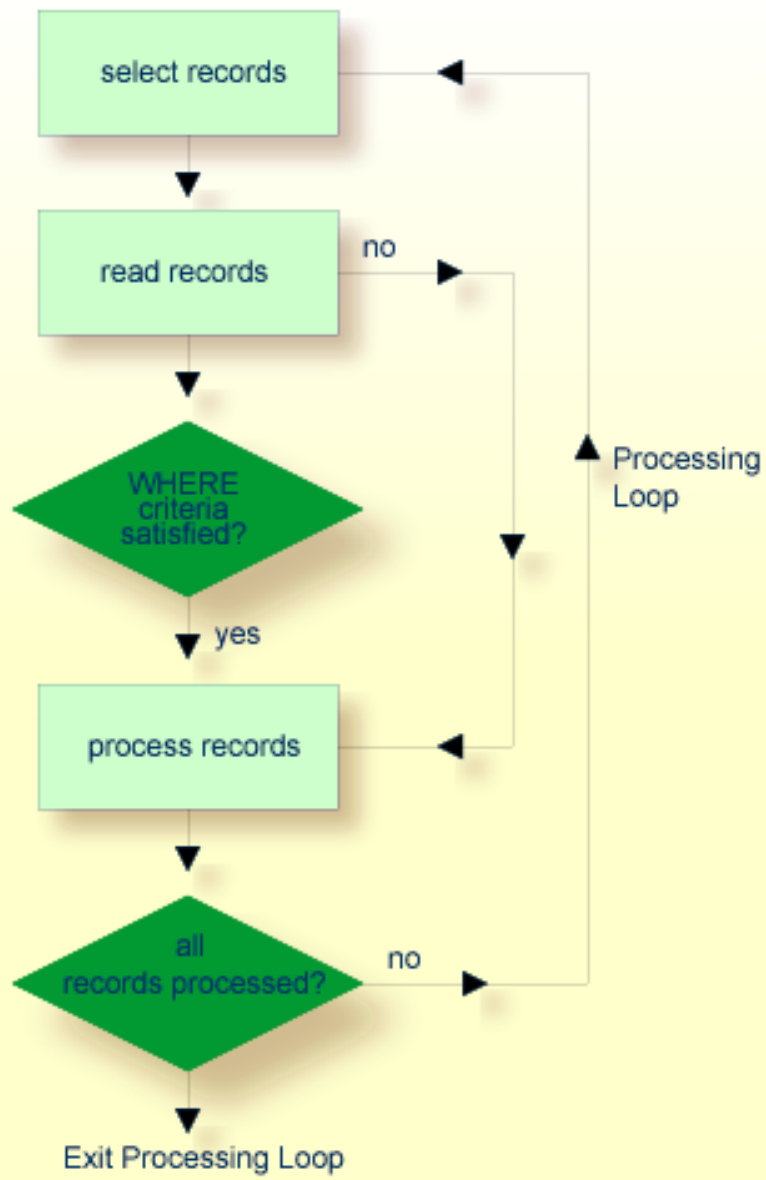

## Hierarchies of Processing Loops

The use of multiple FIND and/or READ statements creates a hierarchy of processing loops, as shown in the following example:

### Example of Processing Loop Hierarchy

```

** Example 'FINDX04': FIND (two FIND statements nested)
*****
DEFINE DATA LOCAL
1 PERSONVIEW VIEW OF EMPLOYEES
  2 PERSONNEL-ID
  2 NAME
1 AUTOVIEW VIEW OF VEHICLES
  2 PERSONNEL-ID
  2 MAKE
  2 MODEL
END-DEFINE
*
EMP. FIND PERSONVIEW WITH NAME = 'ADKINSON'
  VEH. FIND AUTOVIEW WITH PERSONNEL-ID = PERSONNEL-ID (EMP.)
    DISPLAY NAME MAKE MODEL
  END-FIND
END-FIND
END
    
```

The above program selects from the EMPLOYEES file all people with the name ADKINSON. Each record (person) selected is then processed as follows:

1. The second FIND statement is executed to select the automobiles from the VEHICLES file, using as selection criterion the PERSONNEL-IDs from the records selected from the EMPLOYEES file with the first FIND statement.
2. The NAME of each person selected is displayed; this information is obtained from the EMPLOYEES file. The MAKE and MODEL of each automobile owned by that person is also displayed; this information is obtained from the VEHICLES file.

The second FIND statement creates an inner processing loop within the outer processing loop of the first FIND statement, as shown in the following diagram.

The diagram illustrates the flow logic of the hierarchy of processing loops in the previous example program:

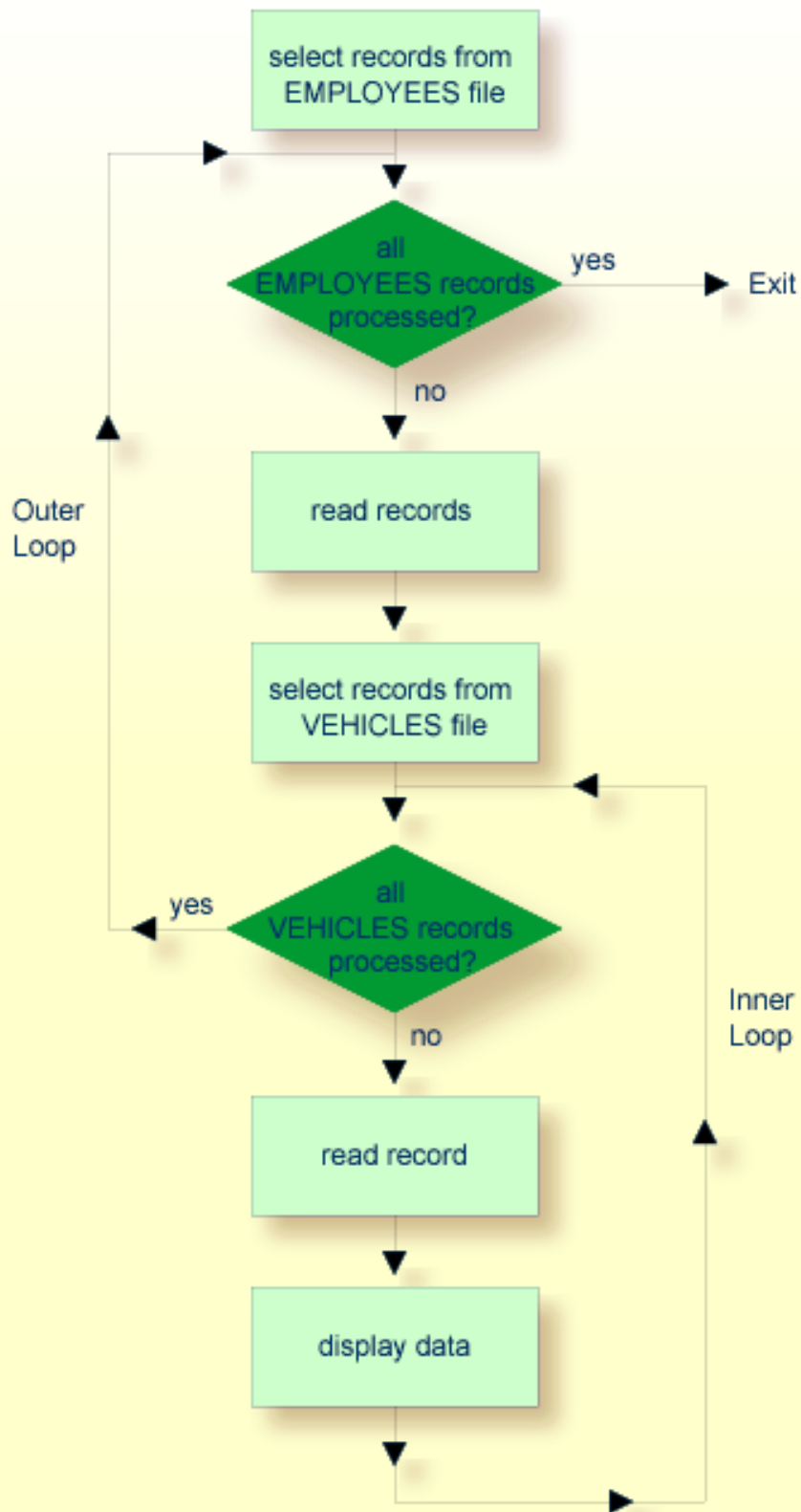

### Example of Nested FIND Loops Accessing the Same File

It is also possible to construct a processing loop hierarchy in which the same file is used at both levels of the hierarchy:

```

** Example 'FINDX05': FIND (two FIND statements on same file nested)
*****
DEFINE DATA LOCAL
1 PERSONVIEW VIEW OF EMPLOYEES
  2 NAME
  2 FIRST-NAME
  2 CITY
1 #NAME (A40)
END-DEFINE
*
WRITE TITLE LEFT JUSTIFIED
  'PEOPLE IN SAME CITY AS:' #NAME / 'CITY:' CITY SKIP 1
*
FIND PERSONVIEW WITH NAME = 'JONES'
      WHERE FIRST-NAME = 'LAUREL'
  COMPRESS NAME FIRST-NAME INTO #NAME
/*
  FIND PERSONVIEW WITH CITY = CITY
    DISPLAY NAME FIRST-NAME CITY
  END-FIND
END-FIND
END
    
```

The above program first selects all people with name JONES and first name LAUREL from the EMPLOYEES file. Then all who live in the same city are selected from the EMPLOYEES file and a list of these people is created. All field values displayed by the DISPLAY statement are taken from the second FIND statement.

#### Output of Program FINDX05:

```

PEOPLE IN SAME CITY AS: JONES LAUREL
CITY: BALTIMORE

      NAME                FIRST-NAME                CITY
-----
JENSON                MARTHA                BALTIMORE
LAWLER                EDDIE                BALTIMORE
FORREST                CLARA                BALTIMORE
ALEXANDER                GIL                BALTIMORE
NEEDHAM                SUNNY                BALTIMORE
ZINN                CARLOS                BALTIMORE
JONES                LAUREL                BALTIMORE
    
```

## Further Examples of Nested READ and FIND Statements

See the following example programs:

- *READX04 - READ statement (in combination with FIND and the system variables \*NUMBER and \*COUNTER)*
- *LIMITX01 - LIMIT statement (for READ, FIND loop processing)*

## Database Update - Transaction Processing

---

This section describes how Natural performs database updating operations based on transactions.

The following topics are covered:

- Logical Transaction
- Record Hold Logic
- Backing Out a Transaction
- Restarting a Transaction
- Example of Using Transaction Data to Restart a Transaction

### Logical Transaction

Natural performs database updating operations based on transactions, which means that all database update requests are processed in logical transaction units. A logical transaction is the smallest unit of work (as defined by you) which must be performed in its entirety to ensure that the information contained in the database is logically consistent.

A logical transaction may consist of one or more update statements (DELETE, STORE, UPDATE) involving one or more database files. A logical transaction may also span multiple Natural programs.

A logical transaction begins when a record is put on “hold”; Natural does this automatically when the record is read for updating, for example, if a FIND loop contains an UPDATE or DELETE statement.

The end of a logical transaction is determined by an END TRANSACTION statement in the program. This statement ensures that all updates within the transaction have been successfully applied, and releases all records that were put on “hold” during the transaction.

**Example:**

```

DEFINE DATA LOCAL
1 MYVIEW VIEW OF EMPLOYEES
  2 NAME
END-DEFINE
FIND MYVIEW WITH NAME = 'SMITH'
  DELETE
  END TRANSACTION
END-FIND
END
    
```

Each record selected would be put on “hold”, deleted, and then - when the END TRANSACTION statement is executed - released from “hold”.



**Note:** The Natural profile parameter ETEOP, as set by the Natural administrator, determines whether or not Natural will generate an END TRANSACTION statement at the end of each Natural program. Ask your Natural administrator for details.

**Example of STORE Statement:**

The following example program adds new records to the EMPLOYEES file.

```

** Example 'STOREX01': STORE (Add new records to EMPLOYEES file)
*
** CAUTION: Executing this example will modify the database records!
*****
DEFINE DATA LOCAL
1 EMPLOYEE-VIEW VIEW OF EMPLOYEES
  2 PERSONNEL-ID(A8)
  2 NAME (A20)
  2 FIRST-NAME (A20)
  2 MIDDLE-I (A1)
  2 SALARY (P9/2)
  2 MAR-STAT (A1)
  2 BIRTH (D)
  2 CITY (A20)
  2 COUNTRY (A3)
*
1 #PERSONNEL-ID (A8)
1 #NAME (A20)
1 #FIRST-NAME (A20)
1 #INITIAL (A1)
1 #MAR-STAT (A1)
1 #SALARY (N9)
1 #BIRTH (A8)
1 #CITY (A20)
1 #COUNTRY (A3)
1 #CONF (A1) INIT <'Y'>
END-DEFINE
    
```

```

*
REPEAT
  INPUT 'ENTER A PERSONNEL ID AND NAME (OR ''END'' TO END)' //
        'PERSONNEL-ID : ' #PERSONNEL-ID //
        'NAME          : ' #NAME /
        'FIRST-NAME   : ' #FIRST-NAME
  /*****
  /* validate entered data
  /*****
  IF #PERSONNEL-ID = 'END' OR #NAME = 'END'
    STOP
  END-IF
  IF #NAME = ' '
    REINPUT WITH TEXT 'ENTER A LAST-NAME'
                MARK 2 AND SOUND ALARM
  END-IF
  IF #FIRST-NAME = ' '
    REINPUT WITH TEXT 'ENTER A FIRST-NAME'
                MARK 3 AND SOUND ALARM
  END-IF
  /*****
  /* ensure person is not already on file
  /*****
  FIP2. FIND NUMBER EMPLOYEE-VIEW WITH PERSONNEL-ID = #PERSONNEL-ID
  /*
  IF *NUMBER (FIP2.) > 0
    REINPUT 'PERSON WITH SAME PERSONNEL-ID ALREADY EXISTS'
            MARK 1 AND SOUND ALARM
  END-IF
  /*****
  /* get further information
  /*****
  INPUT
    'ENTER EMPLOYEE DATA' // // //
    'PERSONNEL-ID          :' #PERSONNEL-ID (AD=IO) /
    'NAME                  :' #NAME (AD=IO) /
    'FIRST-NAME           :' #FIRST-NAME (AD=IO) // //
    'INITIAL               :' #INITIAL /
    'ANNUAL SALARY        :' #SALARY /
    'MARITAL STATUS       :' #MAR-STAT /
    'DATE OF BIRTH (YYYYMMDD) :' #BIRTH /
    'CITY                  :' #CITY /
    'COUNTRY (3 CHARS)    :' #COUNTRY //
    'ADD THIS RECORD (Y/N) :' #CONF (AD=M)
  /*****
  /* ENSURE REQUIRED FIELDS CONTAIN VALID DATA
  /*****
  IF #SALARY < 10000
    REINPUT TEXT 'ENTER A PROPER ANNUAL SALARY' MARK 2
  END-IF
  IF NOT (#MAR-STAT = 'S' OR = 'M' OR = 'D' OR = 'W')
    REINPUT TEXT 'ENTER VALID MARITAL STATUS S=SINGLE ' -

```

```

                'M=MARRIED D=DIVORCED W=WIDOWED' MARK 3
END-IF
IF NOT(#BIRTH = MASK(YYYYMMDD) AND #BIRTH = MASK(1582-2699))
    REINPUT TEXT 'ENTER CORRECT DATE' MARK 4
END-IF
IF #CITY = ' '
    REINPUT TEXT 'ENTER A CITY NAME' MARK 5
END-IF
IF #COUNTRY = ' '
    REINPUT TEXT 'ENTER A COUNTRY CODE' MARK 6
END-IF
IF NOT (#CONF = 'N' OR= 'Y')
    REINPUT TEXT 'ENTER Y (YES) OR N (NO)' MARK 7
END-IF
IF #CONF = 'N'
    ESCAPE TOP
END-IF
/*****
/*  add the record with STORE
*****/
MOVE #PERSONNEL-ID TO EMPLOYEE-VIEW.PERSONNEL-ID
MOVE #NAME         TO EMPLOYEE-VIEW.NAME
MOVE #FIRST-NAME   TO EMPLOYEE-VIEW.FIRST-NAME
MOVE #INITIAL      TO EMPLOYEE-VIEW.MIDDLE-I
MOVE #SALARY       TO EMPLOYEE-VIEW.SALARY (1)
MOVE #MAR-STAT     TO EMPLOYEE-VIEW.MAR-STAT
MOVE EDITED #BIRTH TO EMPLOYEE-VIEW.BIRTH (EM=YYYYMMDD)
MOVE #CITY         TO EMPLOYEE-VIEW.CITY
MOVE #COUNTRY      TO EMPLOYEE-VIEW.COUNTRY
/*
STP3. STORE RECORD IN FILE EMPLOYEE-VIEW
/*
*****/
/* mark end of logical transaction
*****/
END OF TRANSACTION
RESET INITIAL #CONF
END-REPEAT
END

```

**Output of Program STOREX01:**

```

ENTER A PERSONNEL ID AND NAME (OR 'END' TO END)

PERSONNEL ID :

NAME         :
FIRST NAME   :

```



## Record Hold Logic

If Natural is used with Adabas, any record which is to be updated will be placed in “hold” status until an `END TRANSACTION` or `BACKOUT TRANSACTION` statement is issued or the transaction time limit is exceeded.

When a record is placed in “hold” status for one user, the record is not available for update by another user. Another user who wishes to update the same record will be placed in “wait” status until the record is released from “hold” when the first user ends or backs out his/her transaction.

To prevent users from being placed in wait status, the session parameter `WH` (Wait for Record in Hold Status) can be used (see the *Parameter Reference*).

When you use update logic in a program, you should consider the following:

- The maximum time that a record can be in hold status is determined by the Adabas transaction time limit (Adabas parameter `TT`). If this time limit is exceeded, you will receive an error message and all database modifications done since the last `END TRANSACTION` will be made undone.
- The number of records on hold and the transaction time limit are affected by the size of a transaction, that is, by the placement of the `END TRANSACTION` statement in the program. Restart facilities should be considered when deciding where to issue an `END TRANSACTION`. For example, if a majority of records being processed are *not* to be updated, the `GET` statement is an efficient way of controlling the “holding” of records. This avoids issuing multiple `END TRANSACTION` statements and reduces the number of ISNs on hold. When you process large files, you should bear in mind that the `GET` statement requires an additional Adabas call. An example of a `GET` statement is shown below.

### Example of Hold Logic:

```
** Example 'GETX01': GET (put single record in hold with UPDATE stmt)
**
** CAUTION: Executing this example will modify the database records!
*****
DEFINE DATA LOCAL
1 EMPLOY-VIEW VIEW OF EMPLOYEES
  2 NAME
  2 SALARY (1)
END-DEFINE
*
RD. READ EMPLOY-VIEW BY NAME
  DISPLAY EMPLOY-VIEW
  IF SALARY (1) > 1500000
    /*
    GE. GET EMPLOY-VIEW *ISN (RD.)
    /*
    WRITE '=' (50) 'RECORD IN HOLD:' *ISN(RD.)
    COMPUTE SALARY (1) = SALARY (1) * 1.15
    UPDATE (GE.)
```

```

END TRANSACTION
END-IF
END-READ
END

```

### Backing Out a Transaction

During an active logical transaction, that is, before the `END TRANSACTION` statement is issued, you can cancel the transaction by using a `BACKOUT TRANSACTION` statement. The execution of this statement removes all updates that have been applied (including all records that have been added or deleted) and releases all records held by the transaction.

### Restarting a Transaction

With the `END TRANSACTION` statement, you can also store transaction-related information. If processing of the transaction terminates abnormally, you can read this information with a `GET TRANSACTION DATA` statement to ascertain where to resume processing when you restart the transaction.

### Example of Using Transaction Data to Restart a Transaction

The following program updates the `EMPLOYEES` and `VEHICLES` files. After a restart operation, the user is informed of the last `EMPLOYEES` record successfully processed. The user can resume processing from that `EMPLOYEES` record. It would also be possible to set up the restart transaction message to include the last `VEHICLES` record successfully updated before the restart operation.

```

** Example 'GETTRX01': GET TRANSACTION
*
** CAUTION: Executing this example will modify the database records!
*****
DEFINE DATA LOCAL
01 PERSON VIEW OF EMPLOYEES
  02 PERSONNEL-ID      (A8)
  02 NAME              (A20)
  02 FIRST-NAME       (A20)
  02 MIDDLE-I         (A1)
  02 CITY              (A20)
01 AUTO VIEW OF VEHICLES
  02 PERSONNEL-ID      (A8)
  02 MAKE              (A20)
  02 MODEL             (A20)
*
01 ET-DATA
  02 #APPL-ID          (A8) INIT <' '>
  02 #USER-ID          (A8)
  02 #PROGRAM          (A8)
  02 #DATE             (A10)
  02 #TIME             (A8)

```

```

02 #PERSONNEL-NUMBER (A8)
END-DEFINE
*
GET TRANSACTION DATA #APPL-ID #USER-ID #PROGRAM
                        #DATE      #TIME      #PERSONNEL-NUMBER
*
IF #APPL-ID NOT = 'NORMAL'      /* if last execution ended abnormally
AND #APPL-ID NOT = ' '
  INPUT (AD=OIL)
  // 20T '*** LAST SUCCESSFUL TRANSACTION ***' (I)
  / 20T '*****'
  /// 25T 'APPLICATION:' #APPL-ID
  / 32T 'USER:' #USER-ID
  / 29T 'PROGRAM:' #PROGRAM
  / 24T 'COMPLETED ON:' #DATE 'AT' #TIME
  / 20T 'PERSONNEL NUMBER:' #PERSONNEL-NUMBER
END-IF
*
REPEAT
/*
INPUT (AD=MIL) // 20T 'ENTER PERSONNEL NUMBER:' #PERSONNEL-NUMBER
/*
IF #PERSONNEL-NUMBER = '99999999'
  ESCAPE BOTTOM
END-IF
/*
FIND1. FIND PERSON WITH PERSONNEL-ID = #PERSONNEL-NUMBER
  IF NO RECORDS FOUND
    REINPUT 'SPECIFIED NUMBER DOES NOT EXIST; ENTER ANOTHER ONE.'
  END-NOREC
FIND2. FIND AUTO WITH PERSONNEL-ID = #PERSONNEL-NUMBER
  IF NO RECORDS FOUND
    WRITE 'PERSON DOES NOT OWN ANY CARS'
    ESCAPE BOTTOM
  END-NOREC
IF *COUNTER (FIND2.) = 1      /* first pass through the loop
  INPUT (AD=M)
  / 20T 'EMPLOYEES/AUTOMOBILE DETAILS' (I)
  / 20T '-----'
  /// 20T 'NUMBER:' PERSONNEL-ID (AD=0)
  / 22T 'NAME:' NAME ' ' FIRST-NAME ' ' MIDDLE-I
  / 22T 'CITY:' CITY
  / 22T 'MAKE:' MAKE
  / 21T 'MODEL:' MODEL
  UPDATE (FIND1.)           /* update the EMPLOYEES file
ELSE                         /* subsequent passes through the loop
  INPUT NO ERASE (AD=M IP=OFF) // 28T MAKE / 28T MODEL
END-IF
/*
UPDATE (FIND2.)           /* update the VEHICLES file
/*
MOVE *APPLIC-ID TO #APPL-ID

```

```
MOVE *INIT-USER TO #USER-ID
MOVE *PROGRAM   TO #PROGRAM
MOVE *DAT4E     TO #DATE
MOVE *TIME      TO #TIME
/*
END TRANSACTION #APPL-ID #USER-ID #PROGRAM
                #DATE      #TIME      #PERSONNEL-NUMBER
/*
END-FIND                /* for VEHICLES   (FIND2.)
END-FIND                /* for EMPLOYEES (FIND1.)
END-REPEAT             /* for REPEAT
*
STOP                  /* Simulate abnormal transaction end
END TRANSACTION 'NORMAL '
END
```

## Selecting Records Using ACCEPT/REJECT

---

This section discusses the statements `ACCEPT` and `REJECT` which are used to select records based on user-specified logical criteria.

The following topics are covered:

- [Statements Usable with ACCEPT and REJECT](#)
- [Example of ACCEPT Statement](#)
- [Logical Condition Criteria in ACCEPT/REJECT Statements](#)
- [Example of ACCEPT Statement with AND Operator](#)
- [Example of REJECT Statement with OR Operator](#)
- [Further Examples of ACCEPT and REJECT Statements](#)

### Statements Usable with ACCEPT and REJECT

The statements `ACCEPT` and `REJECT` can be used in conjunction with the database access statements:

- `READ`
- `FIND`
- `HISTOGRAM`

### Example of ACCEPT Statement

```

** Example 'ACCEPX01': ACCEPT IF
*****
DEFINE DATA LOCAL
1 MYVIEW VIEW OF EMPLOYEES
  2 NAME
  2 JOB-TITLE
  2 CURR-CODE (1:1)
  2 SALARY    (1:1)
END-DEFINE
*
READ (20) MYVIEW BY NAME WHERE CURR-CODE (1) = 'USD'
ACCEPT IF SALARY (1) >= 40000
  DISPLAY NAME JOB-TITLE SALARY (1)
END-READ
END
    
```

### Output of Program ACCEPX01:

| Page       | 1                | 04-11-11      | 11:11:11 |
|------------|------------------|---------------|----------|
| NAME       | CURRENT POSITION | ANNUAL SALARY |          |
| ADKINSON   | DBA              | 46700         |          |
| ADKINSON   | MANAGER          | 47000         |          |
| ADKINSON   | MANAGER          | 47000         |          |
| AFANASSIEV | DBA              | 42800         |          |
| ALEXANDER  | DIRECTOR         | 48000         |          |
| ANDERSON   | MANAGER          | 50000         |          |
| ATHERTON   | ANALYST          | 43000         |          |
| ATHERTON   | MANAGER          | 40000         | ↵        |

### Logical Condition Criteria in ACCEPT/REJECT Statements

The statements `ACCEPT` and `REJECT` allow you to specify logical conditions in addition to those that were specified in `WITH` and `WHERE` clauses of the `READ` statement.

The logical condition criteria in the `IF` clause of an `ACCEPT / REJECT` statement are evaluated *after* the record has been selected and read.

Logical condition operators include the following (see [Logical Condition Criteria](#) for more detailed information):

|               |    |    |
|---------------|----|----|
| EQUAL         | EQ | := |
| NOT EQUAL TO  | NE | ≠  |
| LESS THAN     | LT | <  |
| LESS EQUAL    | LE | <= |
| GREATER THAN  | GT | >  |
| GREATER EQUAL | GE | >= |

Logical condition criteria in ACCEPT / REJECT statements may also be connected with the Boolean operators AND, OR, and NOT. Moreover, parentheses may be used to indicate logical grouping; see the following examples.

### Example of ACCEPT Statement with AND Operator

The following program illustrates the use of the Boolean operator AND in an ACCEPT statement.

```

** Example 'ACCEPX02': ACCEPT IF ... AND ...
*****
DEFINE DATA LOCAL
1 MYVIEW VIEW OF EMPLOYEES
  2 NAME
  2 JOB-TITLE
  2 CURR-CODE (1:1)
  2 SALARY (1:1)
END-DEFINE
*
READ (20) MYVIEW BY NAME WHERE CURR-CODE (1) = 'USD'
ACCEPT IF SALARY (1) >= 40000
        AND SALARY (1) <= 45000
        DISPLAY NAME JOB-TITLE SALARY (1)
END-READ
END
    
```

### Output of Program ACCEPX02:

|       |            |                  |               |          |
|-------|------------|------------------|---------------|----------|
| Page  | 1          |                  | 04-12-14      | 12:22:01 |
|       | NAME       | CURRENT POSITION | ANNUAL SALARY |          |
| ----- |            |                  |               |          |
|       | AFANASSIEV | DBA              | 42800         |          |
|       | ATHERTON   | ANALYST          | 43000         |          |
|       | ATHERTON   | MANAGER          | 40000         | ←        |

### Example of REJECT Statement with OR Operator

The following program, which uses the Boolean operator OR in a REJECT statement, produces the same output as the ACCEPT statement in the example above, as the logical operators are reversed.

```

** Example 'ACCEPX03': REJECT IF ... OR ...
*****
DEFINE DATA LOCAL
1 MYVIEW VIEW OF EMPLOYEES
  2 NAME
  2 JOB-TITLE
  2 CURR-CODE (1:1)
  2 SALARY (1:1)
END-DEFINE
*
READ (20) MYVIEW BY NAME WHERE CURR-CODE (1) = 'USD'
REJECT IF SALARY (1) < 40000
          OR SALARY (1) > 45000
  DISPLAY NAME JOB-TITLE SALARY (1)
END-READ
END
    
```

Output of Program ACCEPX03:

| NAME       | CURRENT POSITION | ANNUAL SALARY |
|------------|------------------|---------------|
| AFANASSIEV | DBA              | 42800         |
| ATHERTON   | ANALYST          | 43000         |
| ATHERTON   | MANAGER          | 40000         |

### Further Examples of ACCEPT and REJECT Statements

See the following example programs:

- [ACCEPX04 - ACCEPT IF ... LESS THAN ...](#)
- [ACCEPX05 - ACCEPT IF ... AND ...](#)
- [ACCEPX06 - REJECT IF ... OR ...](#)

## AT START/END OF DATA Statements

---

This section discusses the use of the statements `AT START OF DATA` and `AT END OF DATA`.

The following topics are covered:

- [AT START OF DATA Statement](#)
- [AT END OF DATA Statement](#)
- [Example of AT START OF DATA and AT END OF DATA Statements](#)
- [Further Examples of AT START OF DATA and AT END OF DATA](#)

### AT START OF DATA Statement

The `AT START OF DATA` statement is used to specify any processing that is to be performed after the first of a set of records has been read in a database processing loop.

The `AT START OF DATA` statement must be placed within the processing loop.

If the `AT START OF DATA` processing produces any output, this will be output *before the first field value*. By default, this output is displayed left-justified on the page.

### AT END OF DATA Statement

The `AT END OF DATA` statement is used to specify processing that is to be performed after all records for a database processing loop have been processed.

The `AT END OF DATA` statement must be placed within the processing loop.

If the `AT END OF DATA` processing produces any output, this will be output *after the last field value*. By default, this output is displayed left-justified on the page.

### Example of AT START OF DATA and AT END OF DATA Statements

The following example program illustrates the use of the statements `AT START OF DATA` and `AT END OF DATA`.

The Natural system variable `*TIME` has been incorporated into the `AT START OF DATA` statement to display the time of day.

The Natural system function `OLD` has been incorporated into the `AT END OF DATA` statement to display the name of the last person selected.



```

** Example 'ATSTAX01': AT START OF DATA
*****
DEFINE DATA LOCAL
1 MYVIEW VIEW OF EMPLOYEES
  2 CITY
  2 NAME
  2 JOB-TITLE
  2 INCOME (1:1)
    3 CURR-CODE
    3 SALARY
    3 BONUS (1:1)
END-DEFINE
*
WRITE TITLE 'XYZ EMPLOYEE ANNUAL SALARY AND BONUS REPORT' /
READ (3) MYVIEW BY CITY STARTING FROM 'E'
  DISPLAY GIVE SYSTEM FUNCTIONS
    NAME (AL=15) JOB-TITLE (AL=15) INCOME (1)
  /*
  AT START OF DATA
    WRITE 'RUN TIME:' *TIME /
  END-START
  AT END OF DATA
    WRITE / 'LAST PERSON SELECTED:' OLD (NAME) /
  END-ENDDATA
END-READ
*
AT END OF PAGE
  WRITE / 'AVERAGE SALARY:' AVER (SALARY(1))
END-ENDPAGE
END

```

The program produces the following output:

```

                                XYZ EMPLOYEE ANNUAL SALARY AND BONUS REPORT
NAME                               CURRENT          INCOME
      POSITION                        CURRENCY   ANNUAL   BONUS
                                CODE          SALARY
-----
RUN TIME: 12:43:19.1
DUYVERMAN      PROGRAMMER      USD          34000         0
PRATT          SALES PERSON      USD          38000         9000
MARKUSH        TRAINEE           USD          22000         0
LAST PERSON SELECTED: MARKUSH
AVERAGE SALARY:      31333

```

## Further Examples of AT START OF DATA and AT END OF DATA

See the following example programs:

- [ATENDX01 - AT END OF DATA](#)
- [ATSTAX02 - AT START OF DATA](#)
- [WRITEX09 - WRITE \(in combination with AT END OF DATA \)](#)

## Unicode Data

---

Natural enables users to access wide-character fields (format W) in an Adabas database.

The following topics are covered:

- [Data Definition Module](#)
- [Access Configuration](#)
- [Restrictions](#)

### Data Definition Module

Adabas wide-character fields (W) are mapped to Natural format U (Unicode).

The length definition for a Natural field of format U corresponds to half the size of the Adabas field of format W. An Adabas wide-character field of length 200 is, for example, mapped to (U100) in Natural.

### Access Configuration

Natural receives data from Adabas and sends data to Adabas using UTF-16 as common encoding.

This encoding is specified with the `OPRB` parameter and sent to Adabas with the open request. It is used for wide-character fields and applies to the entire Adabas user session.

### Restrictions

Wide-character fields (W) of variable length are not supported.

Collating descriptors are not supported.

For further information on Adabas and Unicode support refer to the specific Adabas product documentation.

# VI

## Controlling Data Output

---

This part describes how to proceed if a Natural program is to produce multiple reports. Furthermore, it discusses various aspects of how you can control the format of an output report created with Natural, that is, the way in which the data are displayed.

**Report Specification - (*rep*) Notation**

**Layout of an Output Page**

**Statements DISPLAY and WRITE**

**Index Notation for Multiple-Value Fields and Periodic Groups**

**Page Titles, Page Breaks, Blank Lines**

**Column Headers**

**Parameters to Influence the Output of Fields**

**Edit Masks - EM Parameter**

**Unicode Edit Masks - EMU Parameter**

**Vertical Displays**



# 25 Report Specification - (rep) Notation

---

- Use of Report Specifications ..... 256
- Statements Concerned ..... 256
- Examples of Report Specification ..... 256

(*rep*) is the output report identifier for which a statement is applicable.

## Use of Report Specifications

---

If a Natural program is to produce multiple reports, the notation (*rep*) must be specified with each output statement (see [Statements Concerned](#), below) which is to be used to create output for any report other than the first report (Report 0).

A value of 0 - 31 may be specified.

The value for (*rep*) may also be a logical name which has been assigned using the `DEFINE PRINTER` statement, see [Example 2](#) below.

## Statements Concerned

---

The notation (*rep*) can be used with the following output statements:

```
AT END OF PAGE | AT TOP OF PAGE | DISPLAY | EJECT | FORMAT | NEWPAGE | PRINT | SKIP | SUSPEND  
IDENTICAL SUPPRESS | WRITE | WRITE TITLE | WRITE TRAILER
```

## Examples of Report Specification

---

### Example 1 - Multiple Reports

```
DISPLAY (1) NAME ...  
WRITE (4) NAME ...
```

### Example 2 - Using Logical Names

```
DEFINE PRINTER (LIST=5) OUTPUT 'LPT1'  
WRITE (LIST) NAME ...
```

# 26

## Layout of an Output Page

---

- Statements Influencing a Report Layout ..... 258
- General Layout Example ..... 258

The following topics are covered:

## Statements Influencing a Report Layout

---

The following statements have an impact on the layout of the report:

| Statement        | Function                                                                                                                                                                                                                                     |
|------------------|----------------------------------------------------------------------------------------------------------------------------------------------------------------------------------------------------------------------------------------------|
| WRITE TITLE      | With this statement, you can specify a page title, that is, text to be output at the top of a page. By default, page titles are centered and not underlined.                                                                                 |
| WRITE TRAILER    | With this statement, you can specify a page trailer, that is, text to be output at the bottom of a page. By default, the trailer lines are centered and not underlined.                                                                      |
| AT TOP OF PAGE   | With this statement, you can specify any processing that is to be performed whenever a new page of the report is started. Any output from this processing will be output below the page title.                                               |
| AT END OF PAGE   | With this statement, you can specify any processing that is to be performed whenever an end-of-page condition occurs. Any output from this processing will be output below any page trailer (as specified with the WRITE TRAILER statement). |
| AT START OF DATA | With this statement, you specify processing that is to be performed after the first record has been read in a database processing loop. Any output from this processing will be output before the first field value. See note below.         |
| AT END OF DATA   | With this statement, you specify processing that is to be performed after all records for a processing loop have been processed. Any output from this processing will be output immediately after the last field value. See note below.      |
| DISPLAY / WRITE  | With these statements, you control the format in which the field values that have been read are to be output. See section <i>Statements DISPLAY and WRITE</i> .                                                                              |



**Note:** The relevance of the statements AT START OF DATA and AT END OF DATA for the output of data is described under *Database Access, AT START/END OF DATA Statements*. The other statements listed above are discussed in other sections of the part *Controlling Data Output*.

## General Layout Example

---

The following example program illustrates the general layout of an output page:



```

** Example 'OUTPUX01': Several sections of output
*****
DEFINE DATA LOCAL
1 EMP-VIEW VIEW OF EMPLOYEES
  2 NAME
  2 FIRST-NAME
  2 BIRTH
END-DEFINE
*
WRITE TITLE   '***** Page Title *****'
WRITE TRAILER '***** Page Trailer *****'
*
AT TOP OF PAGE
  WRITE '===== Top of Page ====='
END-TOPPAGE
AT END OF PAGE
  WRITE '===== End of Page ====='
END-ENDPAGE
*
READ (10) EMP-VIEW BY NAME
/*
  DISPLAY NAME FIRST-NAME BIRTH (EM=YYYY-MM-DD)
/*
AT START OF DATA
  WRITE '>>>>> Start of Data >>>>>'
END-START
AT END OF DATA
  WRITE '<<<<< End of Data <<<<<'
END-ENDDATA
END-READ
END

```

### Output of Program OUTPUX01:

```

***** Page Title *****
===== Top of Page =====
      NAME                FIRST-NAME                DATE
                        OF
                        BIRTH
-----
>>>>> Start of Data >>>>>
ABELLAN                KEPA                1961-04-08
ACHIESON                ROBERT                1963-12-24
ADAM                    SIMONE                1952-01-30
ADKINSON                JEFF                1951-06-15
ADKINSON                PHYLLIS                1956-09-17
ADKINSON                HAZEL                1954-03-19
ADKINSON                DAVID                1946-10-12
ADKINSON                CHARLIE                1950-03-02
ADKINSON                MARTHA                1970-01-01
ADKINSON                TIMMIE                1970-03-03

```

```
<<<< End of Data <<<<  
          ***** Page Trailer *****  
===== End of Page =====
```

# 27

## Statements DISPLAY and WRITE

---

|                                                          |     |
|----------------------------------------------------------|-----|
| ▪ DISPLAY Statement .....                                | 262 |
| ▪ WRITE Statement .....                                  | 263 |
| ▪ Example of DISPLAY Statement .....                     | 264 |
| ▪ Example of WRITE Statement .....                       | 264 |
| ▪ Column Spacing - SF Parameter and nX Notation .....    | 265 |
| ▪ Tab Setting - nT Notation .....                        | 266 |
| ▪ Line Advance - Slash Notation .....                    | 267 |
| ▪ Further Examples of DISPLAY and WRITE Statements ..... | 270 |

The following topics are covered:

## DISPLAY Statement

---

The `DISPLAY` statement produces output in column format; that is, the values for one field are output in a column underneath one another. If multiple fields are output, that is, if multiple columns are produced, these columns are output next to one another horizontally.

The order in which fields are displayed is determined by the sequence in which you specify the field names in the `DISPLAY` statement.

The `DISPLAY` statement in the following program displays for each person first the personnel number, then the name and then the job title:

```

** Example 'DISPLX01': DISPLAY
*****
DEFINE DATA LOCAL
1 VIEWEMP VIEW OF EMPLOYEES
  2 PERSONNEL-ID
  2 NAME
  2 BIRTH
  2 JOB-TITLE
END-DEFINE
*
READ (3) VIEWEMP BY BIRTH
  DISPLAY PERSONNEL-ID NAME JOB-TITLE
END-READ
END
    
```

Output of Program DISPLX01:

```

Page      1                                04-11-11  14:15:54

PERSONNEL      NAME                CURRENT
  ID                POSITION
-----
30020013  GARRET                TYPIST
30016112  TAILOR                WAREHOUSEMAN
20017600  PIETSCH              SECRETARY
    
```

To change the order of the columns that appear in the output report, simply reorder the field names in the `DISPLAY` statement. For example, if you prefer to list employee names first, then job titles followed by personnel numbers, the appropriate `DISPLAY` statement would be:

```

** Example 'DISPLX02': DISPLAY
*****
DEFINE DATA LOCAL
1 VIEWEMP VIEW OF EMPLOYEES
  2 PERSONNEL-ID
  2 NAME
  2 BIRTH
  2 JOB-TITLE
END-DEFINE
*
READ (3) VIEWEMP BY BIRTH
  DISPLAY NAME JOB-TITLE PERSONNEL-ID
END-READ
END

```

Output of Program DISPLX02:

```

Page      1                                04-11-11  14:15:54
      NAME                                CURRENT
      POSITION                                PERSONNEL
      ID
-----
GARRET                                TYPIST                                30020013
TAILOR                                WAREHOUSEMAN                            30016112
PIETSCH                                SECRETARY                                20017600

```

A header is output above each column. Various ways to influence this header are described in the document [Column Headers](#).

## WRITE Statement

The WRITE statement is used to produce output in free format (that is, not in columns). In contrast to the DISPLAY statement, the following applies to the WRITE statement:

- If necessary, it automatically creates a line advance; that is, a field or text element that does not fit onto the current output line, is automatically output in the next line.
- It does not produce any headers.
- The values of a multiple-value field are output next to one another horizontally, and not underneath one another.

The two example programs shown below illustrate the basic differences between the DISPLAY statement and the WRITE statement.

You can also use the two statements in combination with one another, as described later in the document *Vertical Displays*, [Combining DISPLAY and WRITE](#).

## Example of DISPLAY Statement

---

```

** Example 'DISPLX03': DISPLAY
*****
DEFINE DATA LOCAL
1 VIEWEMP VIEW OF EMPLOYEES
  2 NAME
  2 FIRST-NAME
  2 SALARY (1:3)
END-DEFINE
*
READ (2) VIEWEMP BY NAME STARTING FROM 'JONES'
  DISPLAY NAME FIRST-NAME SALARY (1:3)
END-READ
END
    
```

### Output of Program DISPLX03:

```

Page      1                                04-11-11  14:15:54
      NAME                FIRST-NAME        ANNUAL
      -----                -----        SALARY
      -----                -----        -----
JONES                VIRGINIA                46000
                        42300
                        39300
JONES                MARSHA                50000
                        46000
                        42700
    
```

## Example of WRITE Statement

---

```

** Example 'WRITEX01': WRITE
*****
DEFINE DATA LOCAL
1 VIEWEMP VIEW OF EMPLOYEES
  2 NAME
  2 FIRST-NAME
  2 SALARY (1:3)
END-DEFINE
*
READ (2) VIEWEMP BY NAME STARTING FROM 'JONES'
  WRITE NAME FIRST-NAME SALARY (1:3)
END-READ
END
    
```

Output of Program WRITEX01:

|       |          |       |          |          |
|-------|----------|-------|----------|----------|
| Page  | 1        |       | 04-11-11 | 14:15:55 |
| JONES | VIRGINIA | 46000 | 42300    | 39300    |
| JONES | MARSHA   | 50000 | 46000    | 42700    |

## Column Spacing - SF Parameter and nX Notation

By default, the columns output with a DISPLAY statement are separated from one another by *one* space.

With the session parameter SF, you can specify the default number of spaces to be inserted between columns output with a DISPLAY statement. You can set the number of spaces to any value from 1 to 30.

The parameter can be specified with a FORMAT statement to apply to the whole report, or with a DISPLAY statement at statement level, but not at element level.

With the *nX* notation in the DISPLAY statement, you can specify the number of spaces (*n*) to be inserted between two columns. An *nX* notation overrides the specification made with the SF parameter.

```
** Example 'DISPLX04': DISPLAY (with nX)
*****
DEFINE DATA LOCAL
1 VIEWEMP VIEW OF EMPLOYEES
  2 PERSONNEL-ID
  2 NAME
  2 BIRTH
  2 JOB-TITLE
END-DEFINE
*
FORMAT SF=3
READ (3) VIEWEMP BY BIRTH
  DISPLAY PERSONNEL-ID NAME 5X JOB-TITLE
END-READ
END
```

Output of Program DISPLX04:

The above example program produces the following output, where the first two columns are separated by 3 spaces due to the SF parameter in the FORMAT statement, while the second and third columns are separated by 5 spaces due to the notation 5X in the DISPLAY statement:

Page 1 04-11-11 14:15:54

| PERSONNEL<br>ID | NAME    | CURRENT<br>POSITION |
|-----------------|---------|---------------------|
| 30020013        | GARRET  | TYPIST              |
| 30016112        | TAILOR  | WAREHOUSEMAN        |
| 20017600        | PIETSCH | SECRETARY           |

The *nX* notation is also available with the WRITE statement to insert spaces between individual output elements:

```
WRITE PERSONNEL-ID 5X NAME 3X JOB-TITLE
```

With the above statement, 5 spaces will be inserted between the fields PERSONNEL-ID and NAME, and 3 spaces between NAME and JOB-TITLE.

## Tab Setting - nT Notation

With the *nT* notation, which is available with the DISPLAY and the WRITE statement, you can specify the position where an output element is to be output.

```
** Example 'DISPLX05': DISPLAY (with nT)
*****
DEFINE DATA LOCAL
1 VIEWEMP VIEW OF EMPLOYEES
  2 NAME
  2 FIRST-NAME
END-DEFINE
*
READ (3) VIEWEMP BY NAME STARTING FROM 'JONES'
  DISPLAY 5T NAME 30T FIRST-NAME
END-READ
END
```

Output of Program DISPLX05:

The above program produces the following output, where the field NAME is output starting in the 5th position (counted from the left margin of the page), and the field FIRST-NAME starting in the 30th position:



|      |       |            |          |
|------|-------|------------|----------|
| Page | 1     | 04-11-11   | 14:15:54 |
|      | NAME  | FIRST-NAME |          |
|      | ----- | -----      |          |
|      | JONES | VIRGINIA   |          |
|      | JONES | MARSHA     |          |
|      | JONES | ROBERT     |          |

## Line Advance - Slash Notation

With a slash (/) in a DISPLAY or WRITE statement, you cause a line advance.

- In a DISPLAY statement, a slash causes a line advance *between fields* and *within text*.
- In a WRITE statement, a slash causes a line advance only when placed *between fields*; within text, it is treated like an ordinary text character.

When placed between fields, the slash must have a blank on either side.

For multiple line advances, you specify multiple slashes.

### Example 1 - Line Advance in DISPLAY Statement:

```
** Example 'DISPLX06': DISPLAY (with slash '/')
*****
DEFINE DATA LOCAL
1 VIEWEMP VIEW OF EMPLOYEES
  2 NAME
  2 FIRST-NAME
  2 DEPARTMENT
END-DEFINE
*
READ (3) VIEWEMP BY NAME STARTING FROM 'JONES'
  DISPLAY NAME / FIRST-NAME 'DEPART-/MENT' DEPARTMENT
END-READ
END
```

Output of Program DISPLX06:

The above DISPLAY statement produces a line advance after each value of the field NAME and within the text DEPART-MENT:

Page 1 04-11-11 14:15:54

| NAME<br>FIRST-NAME | DEPART-<br>MENT |
|--------------------|-----------------|
| JONES<br>VIRGINIA  | SALE            |
| JONES<br>MARSHA    | MGMT            |
| JONES<br>ROBERT    | TECH            |

**Example 2 - Line Advance in WRITE Statement:**

```

** Example 'WRITEX02': WRITE (with line advance)
*****
DEFINE DATA LOCAL
1 VIEWEMP VIEW OF EMPLOYEES
  2 NAME
  2 FIRST-NAME
  2 DEPARTMENT
END-DEFINE
*
READ (3) VIEWEMP BY NAME STARTING FROM 'JONES'
  WRITE NAME / FIRST-NAME 'DEPART-/MENT' DEPARTMENT //
END-READ
END
    
```

**Output of Program WRITEX02:**

The above WRITE statement produces a line advance after each value of the field NAME, and a double line advance after each value of the field DEPARTMENT, but none within the text DEPART-/MENT:

Page 1 04-11-11 14:15:55

|                   |                   |
|-------------------|-------------------|
| JONES<br>VIRGINIA | DEPART-/MENT SALE |
| JONES<br>MARSHA   | DEPART-/MENT MGMT |
| JONES<br>ROBERT   | DEPART-/MENT TECH |

**Example 3 - Line Advance in DISPLAY and WRITE Statements:**

```

** Example 'DISPLX21': DISPLAY (usage of slash '/' in DISPLAY and WRITE)
*****
DEFINE DATA LOCAL
1 EMPLOY-VIEW VIEW OF EMPLOYEES
  2 CITY
  2 NAME
  2 FIRST-NAME
  2 ADDRESS-LINE (1)
END-DEFINE
*
WRITE TITLE LEFT JUSTIFIED UNDERLINED
  *TIME
  5X 'PEOPLE LIVING IN SALT LAKE CITY'
  21X 'PAGE:' *PAGE-NUMBER /
  15X 'AS OF' *DAT4E //
*
WRITE TRAILER UNDERLINED 'REGISTER OF' / 'SALT LAKE CITY'
*
READ (2) EMPLOY-VIEW WITH CITY = 'SALT LAKE CITY'
  DISPLAY  NAME /
           FIRST-NAME
           'HOME/CITY' CITY
           'STREET/OR BOX NO.' ADDRESS-LINE (1)
  SKIP 1
END-READ
END

```

**Output of Program DISPLX21:**

```

14:15:54.6    PEOPLE LIVING IN SALT LAKE CITY                PAGE:      1
              AS OF 11/11/2004

```

---

| NAME<br>FIRST-NAME  | HOME<br>CITY   | STREET<br>OR BOX NO. |
|---------------------|----------------|----------------------|
| ANDERSON<br>JENNY   | SALT LAKE CITY | 3701 S. GEORGE MASON |
| SAMUELSON<br>MARTIN | SALT LAKE CITY | 7610 W. 86TH STREET  |

REGISTER OF  
SALT LAKE CITY

---

## Further Examples of DISPLAY and WRITE Statements

---

See the following example programs:

- *DISPLX13 - DISPLAY (compare with WRITEX08 using WRITE)*
- *WRITEX08 - WRITE (compare with DISPLX13 using DISPLAY)*
- *DISPLX14 - DISPLAY (with AL, SF and nX)*
- *WRITEX09 - WRITE (in combination with AT END OF DATA)*

# 28 Index Notation for Multiple-Value Fields and Periodic Groups

---

|                                                        |     |
|--------------------------------------------------------|-----|
| ▪ Use of Index Notation .....                          | 272 |
| ▪ Example of Index Notation in DISPLAY Statement ..... | 272 |
| ▪ Example of Index Notation in WRITE Statement .....   | 273 |

This chapter describes how you can use the index notation ( $n:n$ ) to specify how many values of a multiple-value field or how many occurrences of a periodic group are to be output.

## Use of Index Notation

---

With the index notation ( $n:n$ ) you can specify how many values of a multiple-value field or how many occurrences of a periodic group are to be output.

For example, the field `INCOME` in the DDM `EMPLOYEES` is a periodic group which keeps a record of the annual incomes of an employee for each year he/she has been with the company.

These annual incomes are maintained in chronological order. The income of the most recent year is in occurrence 1.

If you wanted to have the annual incomes of an employee for the last three years displayed - that is, occurrences 1 to 3 - you would specify the notation  $(1:3)$  after the field name in a `DISPLAY` or `WRITE` statement (as shown in the following example program).

## Example of Index Notation in DISPLAY Statement

---

```
** Example 'DISPLX07': DISPLAY (with index notation)
*****
DEFINE DATA LOCAL
1 VIEWEMP VIEW OF EMPLOYEES
  2 PERSONNEL-ID
  2 NAME
  2 BIRTH
  2 INCOME (1:3)
    3 CURR-CODE
    3 SALARY
    3 BONUS (1:1)
END-DEFINE
*
READ (3) VIEWEMP BY BIRTH
  DISPLAY PERSONNEL-ID NAME INCOME (1:3)
  SKIP 1
END-READ
END
```

Output of Program `DISPLX07`:

Note that a `DISPLAY` statement outputs multiple values of a multiple-value field underneath one another:

|                 |         |                  |                  |          |          |
|-----------------|---------|------------------|------------------|----------|----------|
| Page            | 1       |                  |                  | 04-11-11 | 14:15:54 |
| PERSONNEL<br>ID | NAME    | CURRENCY<br>CODE | ANNUAL<br>SALARY | BONUS    |          |
| 30020013        | GARRET  | UKL              | 4200             | 0        |          |
|                 |         | UKL              | 4150             | 0        |          |
|                 |         |                  | 0                | 0        |          |
| 30016112        | TAILOR  | UKL              | 7450             | 0        |          |
|                 |         | UKL              | 7350             | 0        |          |
|                 |         | UKL              | 6700             | 0        |          |
| 20017600        | PIETSCH | USD              | 22000            | 0        |          |
|                 |         | USD              | 20200            | 0        |          |
|                 |         | USD              | 18700            | 0        |          |

As a `WRITE` statement displays multiple values horizontally instead of vertically, this may cause a line overflow and a - possibly undesired - line advance.

If you use only a single field within a periodic group (for example, `SALARY`) instead of the entire periodic group, and if you also insert a slash (/) to cause a line advance (as shown in the following example between `NAME` and `JOB-TITLE`), the report format becomes manageable.

## Example of Index Notation in `WRITE` Statement

```
** Example 'WRITEX03': WRITE (with index notation)
*****
DEFINE DATA LOCAL
1 VIEWEMP VIEW OF EMPLOYEES
  2 PERSONNEL-ID
  2 NAME
  2 BIRTH
  2 JOB-TITLE
  2 SALARY (1:3)
END-DEFINE
*
READ (3) VIEWEMP BY BIRTH
  WRITE PERSONNEL-ID NAME / JOB-TITLE SALARY (1:3)
  SKIP 1
END-READ
END
```

Output of Program `WRITEX03`:

## Index Notation for Multiple-Value Fields and Periodic Groups

---

Page 1 04-11-11 14:15:55

30020013 GARRET  
TYPIST 4200 4150 0

30016112 TAILOR  
WAREHOUSEMAN 7450 7350 6700

20017600 PIETSCH  
SECRETARY 22000 20200 18700



# 29

## Page Titles, Page Breaks, Blank Lines

---

|                                                            |     |
|------------------------------------------------------------|-----|
| ▪ Default Page Title .....                                 | 276 |
| ▪ Suppress Page Title - NOTITLE Option .....               | 276 |
| ▪ Define Your Own Page Title - WRITE TITLE Statement ..... | 277 |
| ▪ Logical Page and Physical Page .....                     | 280 |
| ▪ Page Size - PS Parameter .....                           | 282 |
| ▪ Page Advance .....                                       | 282 |
| ▪ New Page with Title .....                                | 285 |
| ▪ Page Trailer - WRITE TRAILER Statement .....             | 286 |
| ▪ Generating Blank Lines - SKIP Statement .....            | 288 |
| ▪ AT TOP OF PAGE Statement .....                           | 289 |
| ▪ AT END OF PAGE Statement .....                           | 290 |
| ▪ Further Example .....                                    | 292 |

This chapter describes various ways of controlling page breaks in a report, the output of page titles at the top of each report page and the generation of empty lines in an output report.

## Default Page Title

---

For each page output via a `DISPLAY` or `WRITE` statement, Natural automatically generates a single default title line. This title line contains the page number, the date and the time of day.

Example:

```
WRITE 'HELLO'  
END
```

The above program produces the following output with default page title:

```
Page      1                                04-12-14  13:19:33  
HELLO  ↵
```

## Suppress Page Title - NOTITLE Option

---

If you wish your report to be output without page titles, you add the keyword `NOTITLE` to the statement `DISPLAY` or `WRITE`.

**Example - `DISPLAY` with `NOTITLE`:**

```
** Example 'DISPLX20': DISPLAY (with NOTITLE)  
*****  
DEFINE DATA LOCAL  
1 EMPLOY-VIEW VIEW OF EMPLOYEES  
  2 CITY  
  2 NAME  
  2 FIRST-NAME  
END-DEFINE  
*  
READ (5) EMPLOY-VIEW BY CITY FROM 'BOSTON'  
  DISPLAY NOTITLE NAME FIRST-NAME CITY  
END-READ  
END
```

Output of Program `DISPLX20`:

| NAME      | FIRST-NAME | CITY   |
|-----------|------------|--------|
| SHAW      | LESLIE     | BOSTON |
| STANWOOD  | VERNON     | BOSTON |
| CREMER    | WALT       | BOSTON |
| PERREAULT | BRENDA     | BOSTON |
| COHEN     | JOHN       | BOSTON |

### Example - WRITE with NOTITLE:

```
WRITE NOTITLE 'HELLO'
END
```

The above program produces the following output without page title:

```
HELLO
```

## Define Your Own Page Title - WRITE TITLE Statement

If you wish a page title of your own to be output instead of the Natural default page title, you use the statement `WRITE TITLE`.

The following topics are covered below:

- [Specifying Text for Your Title](#)
- [Specifying Empty Lines after the Title](#)
- [Title Justification and/or Underlining](#)
- [Title with Page Number](#)

### Specifying Text for Your Title

With the statement `WRITE TITLE`, you specify the text for your title (in apostrophes).

```
WRITE TITLE 'THIS IS MY PAGE TITLE'
WRITE 'HELLO'
END
```

The above program produces the following output:

```
                THIS IS MY PAGE TITLE
HELLO
```

### Specifying Empty Lines after the Title

With the `SKIP` option of the `WRITE TITLE` statement, you can specify the number of empty lines to be output immediately below the title line. After the keyword `SKIP`, you specify the number of empty lines to be inserted.

```
WRITE TITLE 'THIS IS MY PAGE TITLE' SKIP 2
WRITE 'HELLO'
END
```

The above program produces the following output:

```
                THIS IS MY PAGE TITLE
HELLO
```

`SKIP` is not only available as part of the `WRITE TITLE` statement, but also as a stand-alone statement.

### Title Justification and/or Underlining

By default, the page title is centered on the page and not underlined.

The `WRITE TITLE` statement provides the following options which can be used independent of each other:

| Option                      | Effect                                                                                                                                                                                                                                                                                                                                                                                                              |
|-----------------------------|---------------------------------------------------------------------------------------------------------------------------------------------------------------------------------------------------------------------------------------------------------------------------------------------------------------------------------------------------------------------------------------------------------------------|
| <code>LEFT JUSTIFIED</code> | Causes the page trailer to be displayed left-justified.                                                                                                                                                                                                                                                                                                                                                             |
| <code>UNDERLINED</code>     | Causes the title to be displayed underlined. The underlining runs the width of the line size (see also Natural profile and session parameter <code>LS</code> ). By default, titles are underlined with a hyphen (-). However, with the <code>UC</code> session parameter you can specify another character to be used as underlining character (see <a href="#">Underlining Character for Titles and Headers</a> ). |

The following example shows the effect of the `LEFT JUSTIFIED` and `UNDERLINED` options:

```
WRITE TITLE LEFT JUSTIFIED UNDERLINED 'THIS IS MY PAGE TITLE'
SKIP 2
WRITE 'HELLO'
END
```

The above program produces the following output:

```
THIS IS MY PAGE TITLE
-----
```

```
HELLO
```

The `WRITE TITLE` statement is executed whenever a new page is initiated for the report.

### Title with Page Number

In the following examples, the system variable `*PAGE-NUMBER` is used in conjunction with the `WRITE TITLE` statement to output the page number in the title line.

```
** Example 'WTITLX01': WRITE TITLE (with *PAGE-NUMBER)
*****
DEFINE DATA LOCAL
1 VEHIC-VIEW VIEW OF VEHICLES
  2 MAKE
  2 YEAR
  2 MAINT-COST (1)
END-DEFINE
*
LIMIT 5
*
READ VEHIC-VIEW
END-ALL
SORT BY YEAR USING MAKE MAINT-COST (1)
  DISPLAY NOTITLE YEAR MAKE MAINT-COST (1)
  AT BREAK OF YEAR
    MOVE 1 TO *PAGE-NUMBER
    NEWPAGE
  END-BREAK
/*
  WRITE TITLE LEFT JUSTIFIED
    'YEAR:' YEAR 15X 'PAGE' *PAGE-NUMBER
END-SORT
END
```

Output of Program WTITLX01:

| YEAR: | 1980    | PAGE       | 1 |
|-------|---------|------------|---|
| YEAR  | MAKE    | MAINT-COST |   |
| 1980  | RENAULT | 20000      |   |
| 1980  | RENAULT | 20000      |   |
| 1980  | PEUGEOT | 20000      |   |

## Logical Page and Physical Page

---

A *logical page* is the output produced by a Natural program. A *physical page* is your terminal screen on which the output is displayed; or it may be the piece of paper on which the output is printed.

The size of the logical page is determined by the number of lines output by the Natural program.

If more lines are output than fit onto one screen, the logical page will exceed the physical screen, and the remaining lines will be displayed on the next screen.

## Physical Page (Screen)

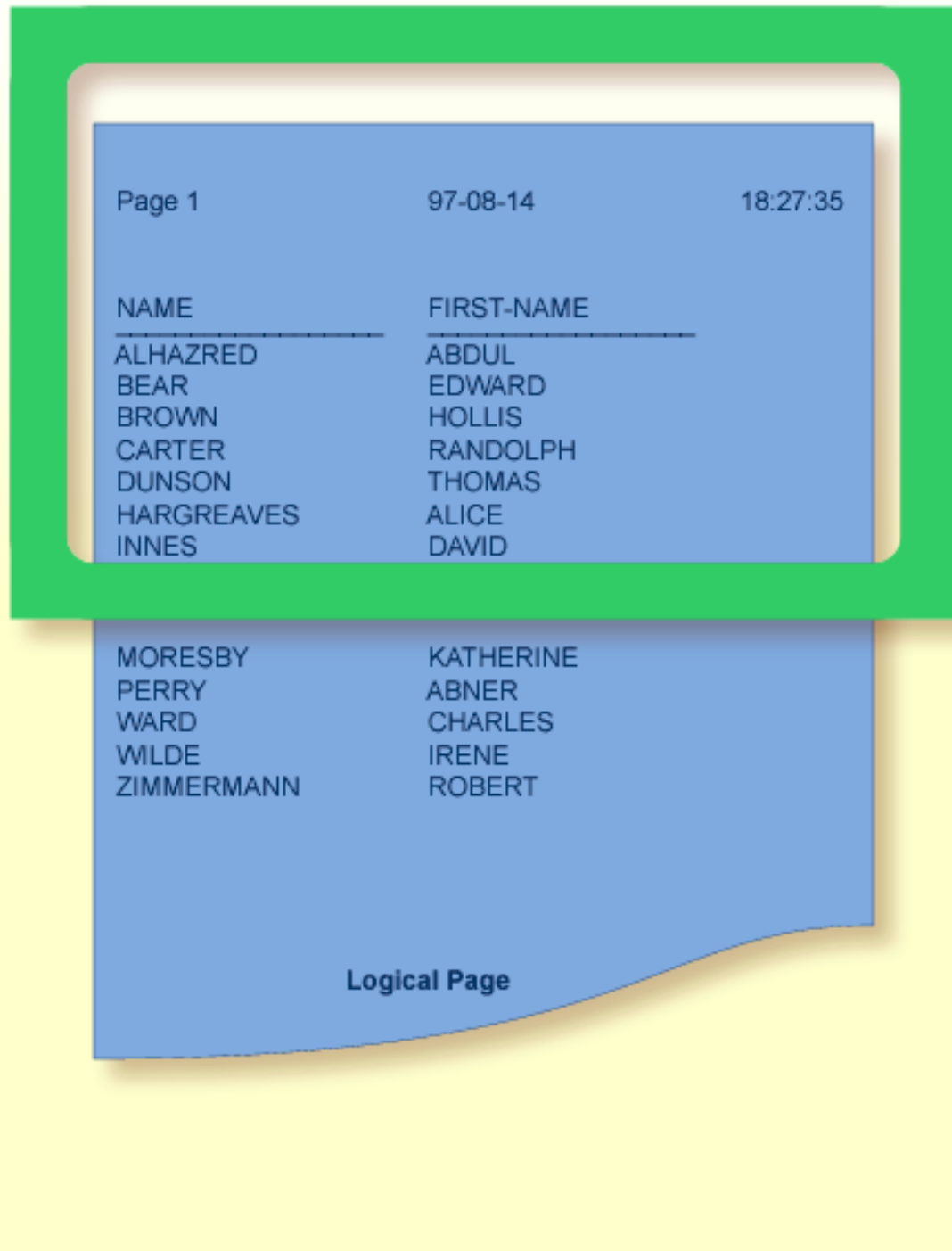

**Note:** If information you wish to appear at the bottom of the screen (for example, output created by a `WRITE TRAILER` or `AT END OF PAGE` statement) is output on the next screen instead, reduce the logical page size accordingly (with the session parameter `PS`, which is discussed below).

## Page Size - PS Parameter

---

With the parameter `PS` (Page Size for Natural Reports), you determine the maximum number of lines per (logical) page for a report.

When the number of lines specified with the `PS` parameter is reached, a page advance occurs (unless page advance is controlled with a `NEWPAGE` or `EJECT` statement; see [Page Advance Controlled by EJ Parameter](#) below).

The `PS` parameter can be set either at session level, or within a program with the following statements:

### At report level:

- `FORMAT PS=nn`

### At statement level:

- `DISPLAY (PS=nn)`
- `WRITE (PS=nn)`
- `WRITE TITLE (PS=nn)`
- `WRITE TRAILER (PS=nn)`
- `INPUT (PS=nn)`

## Page Advance

---

A page advance can be triggered by one of the following methods:

- [Page Advance Controlled by EJ Parameter](#)
- [Page Advance Controlled by EJECT or NEWPAGE Statements](#)
- [Eject/New Page when less than n Lines Left](#)

These methods are discussed below.



## Page Advance Controlled by EJ Parameter

With the session parameter EJ (Page Eject), you determine whether page ejects are to be performed or not. By default, EJ=ON applies, which means that page ejects will be performed as specified.

If you specify EJ=OFF, page break information will be ignored. This may be useful to save paper during test runs where page ejects are not needed.

The EJ parameter can be set at session level; for example:

```
GLOBALS EJ=OFF
```

The EJ parameter setting is overridden by the EJECT statement.

## Page Advance Controlled by EJECT or NEWPAGE Statements

The following topics are covered below:

- [Page Advance without Title/Header on Next Page](#)
- [Page Advance with End/Top-of-Page Processing](#)

### Page Advance without Title/Header on Next Page

The EJECT statement causes a page advance *without* a title or header line being generated on the next page. A new physical page is started *without* any top-of-page or end-of-page processing being performed (for example, no WRITE TRAILER or AT END OF PAGE, WRITE TITLE, AT TOP OF PAGE or \*PAGE-NUMBER processing).

The EJECT statement overrides the EJ parameter setting.

### Page Advance with End/Top-of-Page Processing

The NEWPAGE statement causes a page advance *with* associated end-of-page and top-of-page processing. A trailer line will be displayed, if specified. A title line, either default or user-specified, will be displayed on the new page, unless the NOTITLE option has been specified in a DISPLAY or WRITE statement (as described [above](#)).

If the NEWPAGE statement is not used, page advance is automatically controlled by the setting of the PS parameter; see [Page Size - PS Parameter](#) above).

## Eject/New Page when less than $n$ Lines Left

Both the NEWPAGE statement and the EJECT statement provide a WHEN LESS THAN  $n$  LINES LEFT option. With this option, you specify a number of lines ( $n$ ). The NEWPAGE/EJECT statement will then be executed if - at the time the statement is processed - less than  $n$  lines are available on the current page.

### Example 1:

```
FORMAT PS=55
...
NEWPAGE WHEN LESS THAN 7 LINES LEFT
...
```

In this example, the page size is set to 55 lines.

If only 6 or less lines are left on the current page at the time when the NEWPAGE statement is processed, the NEWPAGE statement is executed and a page advance occurs. If 7 or more lines are left, the NEWPAGE statement is not executed and no page advance occurs; the page advance then occurs depending on the session parameter PS (Page Size for Natural Reports), that is, after 55 lines.

### Example 2:

```
** Example 'NEWPAX02': NEWPAGE (in combination with EJECT and
**                          parameter PS)
*****
DEFINE DATA LOCAL
1 EMPLOY-VIEW VIEW OF EMPLOYEES
  2 CITY
  2 NAME
  2 JOB-TITLE
END-DEFINE
*
FORMAT PS=15
*
READ (9) EMPLOY-VIEW BY CITY STARTING FROM 'BOSTON'
  AT START OF DATA
    EJECT
    WRITE /// 20T '%' (29) /
              20T '%%'                               47T '%%' /
              20T '%%' 3X 'REPORT OF EMPLOYEES' 47T '%%' /
              20T '%%' 3X '  SORTED BY CITY   ' 47T '%%' /
              20T '%%'                               47T '%%' /
              20T '%' (29) /
    NEWPAGE
  END-START
  AT BREAK OF CITY
    NEWPAGE WHEN LESS 3 LINES LEFT
  END-BREAK
  DISPLAY CITY (IS=ON) NAME JOB-TITLE
```

```
END-READ
END
```

## New Page with Title

The `NEWPAGE` statement also provides a `WITH TITLE` option. If this option is not used, a default title will appear at the top of the new page or a `WRITE TITLE` statement or `NOTITLE` clause will be executed.

The `WITH TITLE` option of the `NEWPAGE` statement allows you to override these with a title of your own choice. The syntax of the `WITH TITLE` option is the same as for the `WRITE TITLE` statement.

### Example:

```
NEWPAGE WITH TITLE LEFT JUSTIFIED 'PEOPLE LIVING IN BOSTON:'
```

The following program illustrates the use of the session parameter `PS` (Page Size for Natural Reports) and the `NEWPAGE` statement. Moreover, the system variable `*PAGE-NUMBER` is used to display the current page number.

```
** Example 'NEWPAX01': NEWPAGE
*****
DEFINE DATA LOCAL
1 VIEWEMP VIEW OF EMPLOYEES
  2 NAME
  2 CITY
  2 DEPT
END-DEFINE
*
FORMAT PS=20
READ (5) VIEWEMP BY CITY STARTING FROM 'M'
  DISPLAY NAME 'DEPT' DEPT 'LOCATION' CITY
  AT BREAK OF CITY
    NEWPAGE WITH TITLE LEFT JUSTIFIED
      'EMPLOYEES BY CITY - PAGE:' *PAGE-NUMBER
  END-BREAK
END-READ
END
```

### Output of Program NEWPAX01:

Note the position of the page breaks and the title line:

Page 1 04-11-11 14:15:54

| NAME      | DEPT   | LOCATION |
|-----------|--------|----------|
| -----     |        |          |
| FICKEN    | TECH10 | MADISON  |
| KELLOGG   | TECH10 | MADISON  |
| ALEXANDER | SALE20 | MADISON  |

Page 2:

EMPLOYEES BY CITY - PAGE: 2

| NAME         | DEPT   | LOCATION |
|--------------|--------|----------|
| -----        |        |          |
| DE JUAN      | SALE03 | MADRID   |
| DE LA MADRID | PROD01 | MADRID   |

Page 3:

EMPLOYEES BY CITY - PAGE: 3

## Page Trailer - WRITE TRAILER Statement

---

The following topics are covered below:

- [Specifying a Page Trailer](#)
- [Considering Logical Page Size](#)
- [Page Trailer Justification and/or Underlining](#)

### Specifying a Page Trailer

The `WRITE TRAILER` statement is used to output text (in apostrophes) at the bottom of a page.

```
WRITE TRAILER 'THIS IS THE END OF THE PAGE'
```

The statement is executed when an end-of-page condition is detected, or as a result of a `SKIP` or `NEWPAGE` statement.

## Considering Logical Page Size

As the end-of-page condition is checked only *after* an entire DISPLAY or WRITE statement has been processed, it may occur that the logical page size (that is, the number of lines output by a DISPLAY or WRITE statement) causes the physical size of the output page to be exceeded before the WRITE TRAILER statement is executed.

To ensure that a page trailer actually appears at the bottom of a physical page, you should set the logical page size (with the PS session parameter) to a value less than the physical page size.

## Page Trailer Justification and/or Underlining

By default, the page trailer is displayed centered on the page and not underlined.

The WRITE TRAILER statement provides the following options which can be used independent of each other:

| Option         | Effect                                                                                                                                                                                                                                                                                                                                      |
|----------------|---------------------------------------------------------------------------------------------------------------------------------------------------------------------------------------------------------------------------------------------------------------------------------------------------------------------------------------------|
| LEFT JUSTIFIED | Causes the page trailer to be displayed left justified.                                                                                                                                                                                                                                                                                     |
| UNDERLINED     | The underlining runs the width of the line size (see also Natural profile and session parameter LS). By default, titles are underlined with a hyphen (-). However, with the UC session parameter you can specify another character to be used as underlining character (see <a href="#">Underlining Character for Titles and Headers</a> ). |

The following examples show the use of the LEFT JUSTIFIED and UNDERLINED options of the WRITE TRAILER statement:

### Example 1:

```
WRITE TRAILER LEFT JUSTIFIED UNDERLINED 'THIS IS THE END OF THE PAGE'
```

### Example 2:

```
** Example 'WTITLX02': WRITE TITLE AND WRITE TRAILER
*****
DEFINE DATA LOCAL
1 EMPLOY-VIEW VIEW OF EMPLOYEES
  2 CITY
  2 NAME
  2 FIRST-NAME
  2 ADDRESS-LINE (1)
END-DEFINE
*
WRITE TITLE LEFT JUSTIFIED UNDERLINED
  *TIME
  5X 'PEOPLE LIVING IN SALT LAKE CITY'
  21X 'PAGE:' *PAGE-NUMBER /
```

```
15X 'AS OF' *DAT4E //
*
WRITE TRAILER UNDERLINED 'REGISTER OF' / 'SALT LAKE CITY'
*
READ (2) EMPLOY-VIEW WITH CITY = 'SALT LAKE CITY'
  DISPLAY  NAME /
           FIRST-NAME
           'HOME/CITY' CITY
           'STREET/OR BOX NO.' ADDRESS-LINE (1)
  SKIP 1
END-READ
END
```

## Generating Blank Lines - SKIP Statement

---

The SKIP statement is used to generate one or more blank lines in an output report.

### Example 1 - SKIP in conjunction with WRITE and DISPLAY:

```
** Example 'SKIPX01': SKIP (in conjunction with WRITE and DISPLAY)
*****
DEFINE DATA LOCAL
1 EMPLOY-VIEW VIEW OF EMPLOYEES
  2 CITY
  2 NAME
  2 FIRST-NAME
  2 ADDRESS-LINE (1)
END-DEFINE
*
WRITE TITLE LEFT JUSTIFIED UNDERLINED
      'PEOPLE LIVING IN SALT LAKE CITY AS OF' *DAT4E 7X
      'PAGE:' *PAGE-NUMBER
SKIP 3
*
READ (2) EMPLOY-VIEW WITH CITY = 'SALT LAKE CITY'
  DISPLAY NAME / FIRST-NAME CITY ADDRESS-LINE (1)
  SKIP 1
END-READ
END
```

**Example 2 - SKIP in conjunction with DISPLAY VERT:**

```

** Example 'SKIPX02': SKIP (in conjunction with DISPLAY VERT)
*****
DEFINE DATA LOCAL
1 EMPLOY-VIEW VIEW OF EMPLOYEES
  2 NAME
  2 FIRST-NAME
  2 CITY
  2 JOB-TITLE
END-DEFINE
*
READ (2) EMPLOY-VIEW WITH JOB-TITLE = 'SECRETARY'
  DISPLAY NOTITLE VERT
    NAME FIRST-NAME / CITY
  SKIP 3
END-READ
*
NEWPAGE
*
READ (2) EMPLOY-VIEW WITH JOB-TITLE = 'SECRETARY'
  DISPLAY NOTITLE
    NAME FIRST-NAME / CITY
  SKIP 3
END-READ
END

```

**AT TOP OF PAGE Statement**

The AT TOP OF PAGE statement is used to specify any processing that is to be performed whenever a new page of the report is started.

If the AT TOP OF PAGE processing produces any output, this will be output below the page title (with a skipped line in between).

By default, this output is displayed left-justified on the page.

**Example:**

```

** Example 'ATTOPX01': AT TOP OF PAGE
*****
DEFINE DATA LOCAL
1 EMPLOY-VIEW VIEW OF EMPLOYEES
  2 PERSONNEL-ID
  2 NAME
  2 MAR-STAT
  2 BIRTH
  2 CITY

```

```

2 JOB-TITLE
2 DEPT
END-DEFINE
*
LIMIT 10
READ EMPLOY-VIEW BY PERSONNEL-ID FROM '20017000'
  DISPLAY NOTITLE (AL=10)
    NAME DEPT JOB-TITLE CITY 5X
    MAR-STAT 'DATE OF/BIRTH' BIRTH (EM=YY-MM-DD)
/*
AT TOP OF PAGE
  WRITE /   '-BUSINESS INFORMATION-'
    26X '-PRIVATE INFORMATION-'
END-TOPPAGE
END-READ
END

```

Output of Program ATTOPX01:

| -BUSINESS INFORMATION- |                    |                     |            | -PRIVATE INFORMATION- |                  |
|------------------------|--------------------|---------------------|------------|-----------------------|------------------|
| NAME                   | DEPARTMENT<br>CODE | CURRENT<br>POSITION | CITY       | MARITAL<br>STATUS     | DATE OF<br>BIRTH |
| CREMER                 | TECH10             | ANALYST             | GREENVILLE | S                     | 70-01-01         |
| MARKUSH                | SALE00             | TRAINEE             | LOS ANGELE | D                     | 79-03-14         |
| GEE                    | TECH05             | MANAGER             | CHAPEL HIL | M                     | 41-02-04         |
| KUNEY                  | TECH10             | DBA                 | DETROIT    | S                     | 40-02-13         |
| NEEDHAM                | TECH10             | PROGRAMMER          | CHATTANOOG | S                     | 55-08-05         |
| JACKSON                | TECH10             | PROGRAMMER          | ST LOUIS   | D                     | 70-01-01         |
| PIETSCH                | MGMT10             | SECRETARY           | VISTA      | M                     | 40-01-09         |
| PAUL                   | MGMT10             | SECRETARY           | NORFOLK    | S                     | 43-07-07         |
| HERZOG                 | TECH05             | MANAGER             | CHATTANOOG | S                     | 52-09-16         |
| DEKKER                 | TECH10             | DBA                 | MOBILE     | W                     | 40-03-03         |

## AT END OF PAGE Statement

---

The AT END OF PAGE statement is used to specify any processing that is to be performed whenever an end-of-page condition occurs.

If the AT END OF PAGE processing produces any output, this will be output after any **page trailer** (as specified with the WRITE TRAILER statement).

By default, this output is displayed left-justified on the page.



The same considerations [described above](#) for page trailers regarding physical and logical page sizes and the number of lines output by a DISPLAY or WRITE statement also apply to AT END OF PAGE output.

**Example:**

```

** Example 'ATENPX01': AT END OF PAGE (with system function available
**                               via GIVE SYSTEM FUNCTIONS in DISPLAY)
*****
DEFINE DATA LOCAL
1 EMPLOY-VIEW VIEW OF EMPLOYEES
  2 PERSONNEL-ID
  2 NAME
  2 JOB-TITLE
  2 SALARY (1)
END-DEFINE
*
READ (10) EMPLOY-VIEW BY PERSONNEL-ID = '20017000'
  DISPLAY NOTITLE GIVE SYSTEM FUNCTIONS
    NAME JOB-TITLE 'SALARY' SALARY(1)
  /*
  AT END OF PAGE
    WRITE / 24T 'AVERAGE SALARY: ...' AVER(SALARY(1))
  END-ENDPAGE
END-READ
END

```

**Output of Program ATENPX01:**

| NAME                | CURRENT<br>POSITION | SALARY |
|---------------------|---------------------|--------|
| CREMER              | ANALYST             | 34000  |
| MARKUSH             | TRAINEE             | 22000  |
| GEE                 | MANAGER             | 39500  |
| KUNEY               | DBA                 | 40200  |
| NEEDHAM             | PROGRAMMER          | 32500  |
| JACKSON             | PROGRAMMER          | 33000  |
| PIETSCH             | SECRETARY           | 22000  |
| PAUL                | SECRETARY           | 23000  |
| HERZOG              | MANAGER             | 48500  |
| DEKKER              | DBA                 | 48000  |
| AVERAGE SALARY: ... | 34270               |        |

↵

## Further Example

---

See the following example program:

- *DISPLX21 - DISPLAY (with slash '/' and compare with WRITE)*

# 30

## Column Headers

---

- Default Column Headers ..... 294
- Suppress Default Column Headers - NOHDR Option ..... 294
- Define Your Own Column Headers ..... 295
- Combining NOTITLE and NOHDR ..... 296
- Centering of Column Headers - HC Parameter ..... 296
- Width of Column Headers - HW Parameter ..... 296
- Filler Characters for Headers - Parameters FC and GC ..... 297
- Underlining Character for Titles and Headers - UC Parameter ..... 298
- Suppressing Column Headers - Slash Notation ..... 299
- Further Examples of Column Headers ..... 300

The following topics are covered:

## Default Column Headers

---

By default, each database field output with a `DISPLAY` statement is displayed with a default column header (which is defined for the field in the DDM).

```
** Example 'DISPLX01': DISPLAY
*****
DEFINE DATA LOCAL
1 VIEWEMP VIEW OF EMPLOYEES
  2 PERSONNEL-ID
  2 NAME
  2 BIRTH
  2 JOB-TITLE
END-DEFINE
*
READ (3) VIEWEMP BY BIRTH
  DISPLAY PERSONNEL-ID NAME JOB-TITLE
END-READ
END
```

Output of Program DISPLX01:

The above example program uses default headers and produces the following output.

```
Page      1                                04-11-11  14:15:54

PERSONNEL          NAME                CURRENT
  ID                POSITION
-----
30020013  GARRET                TYPIST
30016112  TAILOR                  WAREHOUSEMAN
20017600  PIETSCH                 SECRETARY
```

## Suppress Default Column Headers - NOHDR Option

---

If you wish your report to be output without column headers, add the keyword `NOHDR` to the `DISPLAY` statement.

```
DISPLAY NOHDR PERSONNEL-ID NAME JOB-TITLE
```

## Define Your Own Column Headers

If you wish column headers of your own to be output instead of the default headers, you specify '*text*' (in apostrophes) immediately before a field, *text* being the header to be used for the field.

```
** Example 'DISPLX08': DISPLAY (with column title in 'text')
*****
DEFINE DATA LOCAL
1 VIEWEMP VIEW OF EMPLOYEES
  2 PERSONNEL-ID
  2 NAME
  2 BIRTH
  2 JOB-TITLE
END-DEFINE
*
READ (3) VIEWEMP BY BIRTH
  DISPLAY PERSONNEL-ID
           'EMPLOYEE' NAME
           'POSITION' JOB-TITLE
END-READ
END
```

**Output of Program DISPLX08:**

The above program contains the header `EMPLOYEE` for the field `NAME`, and the header `POSITION` for the field `JOB-TITLE`; for the field `PERSONNEL-ID`, the default header is used. The program produces the following output:

```
Page      1                                04-11-11  14:15:54
PERSONNEL      EMPLOYEE      POSITION
  ID
-----
30020013  GARRET                TYPIST
30016112  TAILOR                  WAREHOUSEMAN
20017600  PIETSCH                 SECRETARY
```

## Combining NOTITLE and NOHDR

To create a report that has neither page title nor column headers, you specify the NOTITLE and NOHDR options together in the following order:

```
DISPLAY NOTITLE NOHDR PERSONNEL-ID NAME JOB-TITLE
```

## Centering of Column Headers - HC Parameter

By default, column headers are centered above the columns. With the HC parameter, you can influence the placement of column headers.

If you specify

|      |                                  |
|------|----------------------------------|
| HC=L | headers will be left-justified.  |
| HC=R | headers will be right-justified. |
| HC=C | headers will be centered.        |

The HC parameter can be used in a FORMAT statement to apply to the whole report, or it can be used in a DISPLAY statement at both statement level and element level, for example:

```
DISPLAY (HC=L) PERSONNEL-ID NAME JOB-TITLE
```

## Width of Column Headers - HW Parameter

With the HW parameter, you determine the width of a column output with a DISPLAY statement.

If you specify

|        |                                                                                                                                                                                                                                                                    |
|--------|--------------------------------------------------------------------------------------------------------------------------------------------------------------------------------------------------------------------------------------------------------------------|
| HW=ON  | the width of a DISPLAY column is determined by either the length of the header text or the length of the field, whichever is longer. This also applies by default.                                                                                                 |
| HW=OFF | the width of a DISPLAY column is determined only by the length of the field. However, HW=OFF only applies to DISPLAY statements which do <i>not</i> create headers; that is, either a first DISPLAY statement with NOHDR option or a subsequent DISPLAY statement. |

The HW parameter can be used in a FORMAT statement to apply to the entire report, or it can be used in a DISPLAY statement at both statement level and element (field) level.

## Filler Characters for Headers - Parameters FC and GC

With the `FC` parameter, you specify the *filler character* which will appear on either side of a *header* produced by a `DISPLAY` statement across the full column width if the column width is determined by the field length and not by the header (see `HW` parameter [above](#)); otherwise `FC` will be ignored.

When a group of fields or a periodic group is output via a `DISPLAY` statement, a *group header* is displayed across all field columns that belong to that group above the headers for the individual fields within the group. With the `GC` parameter, you can specify the *filler character* which will appear on either side of such a group header.

While the `FC` parameter applies to the headers of individual fields, the `GC` parameter applies to the headers for groups of fields.

The parameters `FC` and `GC` can be specified in a `FORMAT` statement to apply to the whole report, or they can be specified in a `DISPLAY` statement at both statement level and element (field) level.

```
** Example 'FORMAX01': FORMAT (with parameters FC, GC)
*****
DEFINE DATA LOCAL
1 VIEWEMP VIEW OF EMPLOYEES
  2 NAME
  2 INCOME (1:1)
  3 CURR-CODE
  3 SALARY
  3 BONUS (1:1)
END-DEFINE
*
FORMAT FC=* GC=$
*
READ (3) VIEWEMP BY NAME
  DISPLAY NAME (FC==) INCOME (1)
END-READ
END
```

### Output of Program FORMAX01:

```
Page      1                                04-11-11  14:15:54

=====NAME=====  $$$$$$$$$$INCOME$$$$$$$$$$$
                                CURRENCY  **ANNUAL**  **BONUS**
                                CODE        SALARY
-----
ABELLAN             PTA          1450000          0
ACHIESON            UKL           10500            0
ADAM                FRA          159980           23000
```

## Underlining Character for Titles and Headers - UC Parameter

---

By default, titles and headers are underlined with a hyphen (-).

With the UC parameter, you can specify another character to be used as underlining character.

The UC parameter can be specified in a FORMAT statement to apply to the whole report, or it can be specified in a DISPLAY statement at both statement level and element (field) level.

```

** Example 'FORMAX02': FORMAT (with parameter UC)
*****
DEFINE DATA LOCAL
1 VIEWEMP VIEW OF EMPLOYEES
  2 PERSONNEL-ID
  2 NAME
  2 BIRTH
  2 JOB-TITLE
END-DEFINE
*
FORMAT UC==
*
WRITE TITLE LEFT JUSTIFIED UNDERLINED 'EMPLOYEES REPORT'
SKIP 1
READ (3) VIEWEMP BY BIRTH
  DISPLAY PERSONNEL-ID (UC=*) NAME JOB-TITLE
END-READ
END
    
```

In the above program, the UC parameter is specified at program level and at element (field) level: the underlining character specified with the FORMAT statement (=) applies for the whole report - except for the field PERSONNEL-ID, for which a different underlining character (\*) is specified.

Output of Program FORMAX02:

```

EMPLOYEES REPORT
=====
PERSONNEL          NAME          CURRENT
  ID              POSITION
*****
30020013  GARRET          TYPIST
30016112  TAILOR          WAREHOUSEMAN
20017600  PIETSCH         SECRETARY
    
```



## Suppressing Column Headers - Slash Notation

With the notation apostrophe-slash-apostrophe ('/'), you can suppress default column headers for individual fields displayed with a `DISPLAY` statement. While the `NOHDR` option suppresses the headers of all columns, the notation `'/'` can be used to suppress the header for an individual column.

The apostrophe-slash-apostrophe ('/') notation is specified in the `DISPLAY` statement immediately before the name of the field for which the column header is to be suppressed.

Compare the following two examples:

### Example 1:

```
DISPLAY NAME PERSONNEL-ID JOB-TITLE
```

In this case, the default column headers of all three fields will be displayed:

```
Page      1                                04-11-11  14:15:54
          NAME          PERSONNEL          CURRENT
                   ID              POSITION
-----
ABELLAN          60008339  MAQUINISTA
ACHIESON          30000231  DATA BASE ADMINISTRATOR
ADAM              50005800  CHEF DE SERVICE
ADKINSON          20008800  PROGRAMMER
ADKINSON          20009800  DBA
ADKINSON          20011000  SALES PERSON  ←
```

### Example 2:

```
DISPLAY '/' NAME PERSONNEL-ID JOB-TITLE
```

In this case, the notation `'/'` causes the column header for the field `NAME` to be suppressed:

```
Page      1                                04-11-11  14:15:54
          PERSONNEL          CURRENT
                   ID              POSITION
-----
ABELLAN          60008339  MAQUINISTA
ACHIESON          30000231  DATA BASE ADMINISTRATOR
ADAM              50005800  CHEF DE SERVICE
ADKINSON          20008800  PROGRAMMER
```

|          |          |              |   |
|----------|----------|--------------|---|
| ADKINSON | 20009800 | DBA          |   |
| ADKINSON | 20011000 | SALES PERSON | ↵ |

## Further Examples of Column Headers

---

See the following example programs:

- *DISPLX15 - DISPLAY (with FC, UC)*
- *DISPLX16 - DISPLAY (with ', 'text', 'text/text')*

# 31 Parameters to Influence the Output of Fields

---

|                                                              |     |
|--------------------------------------------------------------|-----|
| ▪ Overview of Field-Output-Relevant Parameters .....         | 302 |
| ▪ Leading Characters - LC Parameter .....                    | 302 |
| ▪ Unicode Leading Characters - LCU Parameter .....           | 303 |
| ▪ Insertion Characters - IC Parameter .....                  | 303 |
| ▪ Unicode Insertion Characters - ICU Parameter .....         | 304 |
| ▪ Trailing Characters - TC Parameter .....                   | 304 |
| ▪ Unicode Trailing Characters - TCU Parameter .....          | 304 |
| ▪ Output Length - AL and NL Parameters .....                 | 305 |
| ▪ Display Length for Output - DL Parameter .....             | 305 |
| ▪ Sign Position - SG Parameter .....                         | 307 |
| ▪ Identical Suppress - IS Parameter .....                    | 309 |
| ▪ Zero Printing - ZP Parameter .....                         | 311 |
| ▪ Empty Line Suppression - ES Parameter .....                | 311 |
| ▪ Further Examples of Field-Output-Relevant Parameters ..... | 313 |

This chapter discusses the use of those Natural profile and/or session parameters which you can use to control the output format of fields.

## Overview of Field-Output-Relevant Parameters

---

Natural provides several profile and/or session parameters you can use to control the format in which fields are output:

| Parameter        | Function                                                                                                                                              |
|------------------|-------------------------------------------------------------------------------------------------------------------------------------------------------|
| LC, IC and TC    | With these session parameters, you can specify characters that are to be displayed before or after a field or before a field value.                   |
| LCU, ICU and TCU | With these session parameters, you can specify characters in Unicode format that are to be displayed before or after a field or before a field value. |
| AL and NL        | With these session parameters, you can increase or reduce the output length of fields.                                                                |
| DL               | With this session parameter, you can specify the default output length for an alphanumeric map field of format U.                                     |
| SG               | With this session parameter, you can determine whether negative values are to be displayed with or without a minus sign.                              |
| IS               | With this session parameter, you can suppress the display of subsequent identical field values.                                                       |
| ZP               | With this profile and session parameter, you can determine whether field values of 0 are to be displayed or not.                                      |
| ES               | With this session parameter, you can suppress the display of empty lines generated by a DISPLAY or WRITE statement.                                   |

These parameters are discussed in the following sections.

### Leading Characters - LC Parameter

---

With the session parameter LC, you can specify leading characters that are to be displayed immediately *before a field* that is output with a DISPLAY statement. The width of the output column is enlarged accordingly. You can specify 1 to 10 characters.

By default, values are displayed left-justified in alphanumeric fields and right-justified in numeric fields. (These defaults can be changed with the AD parameter; see the *Parameter Reference*). When a leading character is specified for an alphanumeric field, the character is therefore displayed immediately before the field value; for a numeric field, a number of spaces may occur between the leading character and the field value.

The LC parameter can be used with the following statements:

- FORMAT
- DISPLAY

The `LC` parameter can be set at statement level and at element level.

## Unicode Leading Characters - LCU Parameter

---

The session parameter `LCU` is identical to the session parameter `LC`. The difference is that the leading characters are always stored in Unicode format.

This allows you to specify leading characters with mixed characters from different code pages, and assures that always the correct character is displayed independent of the installed system code page.

For further information, see *Unicode and Code Page Support in the Natural Programming Language, Session Parameters*, section *EMU, ICU, LCU, TCU versus EM, IC, LC, TC*.

The parameters `LCU` and `ICU` cannot both be applied to one field.

## Insertion Characters - IC Parameter

---

With the session parameter `IC`, you specify the characters to be inserted in the column immediately *preceding the value of a field* that is output with a `DISPLAY` statement. You can specify 1 to 10 characters.

For a numeric field, the insertion characters will be placed immediately before the first significant digit that is output, with no intervening spaces between the specified character and the field value. For alphanumeric fields, the effect of the `IC` parameter is the same as that of the `LC` parameter.

The parameters `LC` and `IC` cannot both be applied to one field.

The `IC` parameter can be used with the following statements:

- FORMAT
- DISPLAY

The `IC` parameter can be set at statement level and at element level.

## Unicode Insertion Characters - ICU Parameter

---

The session parameter `ICU` is identical to the session parameter `IC`. The difference is that the insertion characters are always stored in Unicode format.

This allows you to specify insertion characters with mixed characters from different code pages, and assures that always the correct character is displayed independent of the installed system code page.

For further information, see *Unicode and Code Page Support in the Natural Programming Language, Session Parameters*, section *EMU, ICU, LCU, TCU versus EM, IC, LC, TC*.

The parameters `LCU` and `ICU` cannot both be applied to one field.

## Trailing Characters - TC Parameter

---

With the session parameter `TC`, you can specify trailing characters that are to be displayed immediately *to the right of a field* that is output with a `DISPLAY` statement. The width of the output column is enlarged accordingly. You can specify 1 to 10 characters.

The `TC` parameter can be used with the following statements:

- `FORMAT`
- `DISPLAY`

The `TC` parameter can be set at statement level and at element level.

## Unicode Trailing Characters - TCU Parameter

---

The session parameter `TCU` is identical to the session parameter `TC`. The difference is that the trailing characters are always stored in Unicode format.

This allows you to specify trailing characters with mixed characters from different code pages, and assures that always the correct character is displayed independent of the installed system code page.

For further information, see *Unicode and Code Page Support in the Natural Programming Language, Session Parameters*, section *EMU, ICU, LCU, TCU versus EM, IC, LC, TC*.

## Output Length - AL and NL Parameters

---

With the session parameter `AL`, you can specify the *output length for an alphanumeric field*; with the `NL` parameter, you can specify the *output length for a numeric field*. This determines the length of a field as it will be output, which may be shorter or longer than the actual length of the field (as defined in the DDM for a database field, or in the `DEFINE DATA` statement for a user-defined variable).

Both parameters can be used with the following statements:

- `FORMAT`
- `DISPLAY`
- `WRITE`
- `PRINT`
- `INPUT`

Both parameters can be set at statement level and at element level.



**Note:** If an edit mask is specified, it overrides an `NL` or `AL` specification. [Edit masks](#) are described in [Edit Masks - EM Parameter](#).

## Display Length for Output - DL Parameter

---



**Note:** You should use the Web I/O Interface to make use of the full functionality of the `DL` parameter. When using the terminal emulation, it is not possible, for example, to scroll in a field when the value defined with `DL` is smaller than the field length.

With the session parameter `DL`, you can specify the *display length for a field of format A or U*, since the display width of a Unicode string can be twice the length of the string, and the user must be able to display the whole string. The default will be the length, for example, for a format/length `U10`, the display length can be 10 to 20, whereas the default length (when `DL` is not specified) is 10.

The session parameter `DL` can be used with the following statements:

- `FORMAT`
- `DISPLAY`
- `WRITE`
- `PRINT`

### ■ INPUT

The session parameter `DL` can be set at statement level and at element level.

The difference between the session parameters `AL` and `DL` is that `AL` defines the data length of a field whereas `DL` defines the number of columns which are used on the screen for displaying the field. The user can scroll in input fields to view the entire content of a field if the value specified with the `DL` session parameter is less than the length of the field data.

Using the `DL` parameter with a length that is smaller than the length of the field is only recommended with the Web I/O Interface. When running Natural in a terminal emulation, scrolling in a field is not possible and so the effect is the same as using the `AL` parameter. Moreover, when changing the field contents, all characters which are beyond the display length will be lost.



**Note:** `DL` is allowed for A-format fields as well. In conjunction with the Web I/O Interface, this would allow making the edit control size smaller than the content of a field.

### Example:

```
DEFINE DATA LOCAL
1   #U1 (U10)
1   #U2 (U10)
END-DEFINE
*
#U1 := U'latintxt00'
#U2 := U'特别是伺服器都需要支'
*
INPUT (AD=M) #U1 #U2
END
```

The above program produces the following output where the content of the field `#U2` is incomplete:

```
#U1 latintxt00 #U2 特别是伺服
```

When the session parameter `DL` is used with the field `#U2` and is specified accordingly, the content of this field will be displayed correctly:

```
DEFINE DATA LOCAL
1   #U1 (U10)
1   #U2 (U10)
END-DEFINE
*
#U1 := U'latintxt00'
#U2 := U'特别是伺服器都需要支'
*
INPUT (AD=M) #U1 #U2 (DL=20)
END
```

Result:



```
#U1 latinxt00 #U2 特别是伺服器都需要支
```

## Sign Position - SG Parameter

With the session parameter `SG`, you can determine whether or not a sign position is to be allocated for numeric fields.

- By default, `SG=ON` applies, which means that a sign position is allocated for numeric fields.
- If you specify `SG=OFF`, negative values in numeric fields will be output without a minus sign (-).

The `SG` parameter can be used with the following statements:

- `FORMAT`
- `DISPLAY`
- `PRINT`
- `WRITE`
- `INPUT`

The `SG` parameter can be set at both statement level and element level.



**Note:** If an edit mask is specified, it overrides an `SG` specification. [Edit masks](#) are described in [Edit Masks - EM Parameter](#).

### Example Program without Parameters

```
** Example 'FORMAX03': FORMAT (without FORMAT and compare with FORMAX04)
*****
DEFINE DATA LOCAL
1 VIEWEMP VIEW OF EMPLOYEES
  2 NAME
  2 FIRST-NAME
  2 SALARY (1:1)
  2 BONUS (1:1,1:1)
END-DEFINE
*
READ (5) VIEWEMP BY NAME STARTING FROM 'JONES'
  DISPLAY NAME
    FIRST-NAME
    SALARY (1:1)
    BONUS (1:1,1:1)
END-READ
END
```

The above program contains no parameter settings and produces the following output:

|       |      |            |                  |          |          |
|-------|------|------------|------------------|----------|----------|
| Page  | 1    |            |                  | 04-11-11 | 11:11:11 |
|       | NAME | FIRST-NAME | ANNUAL<br>SALARY | BONUS    |          |
| ----- |      |            |                  |          |          |
| JONES |      | VIRGINIA   | 46000            | 9000     |          |
| JONES |      | MARSHA     | 50000            | 0        |          |
| JONES |      | ROBERT     | 31000            | 0        |          |
| JONES |      | LILLY      | 24000            | 0        |          |
| JONES |      | EDWARD     | 37600            | 0        |          |

### Example Program with Parameters AL, NL, LC, IC and TC

In this example, the session parameters AL, NL, LC, IC and TC are used.

```
** Example 'FORMAX04': FORMAT (with parameters AL, NL, LC, TC, IC and
** compare with FORMAX03)
*****
DEFINE DATA LOCAL
1 VIEWEMP VIEW OF EMPLOYEES
  2 NAME
  2 FIRST-NAME
  2 SALARY (1:1)
  2 BONUS (1:1,1:1)
END-DEFINE
*
FORMAT AL=10 NL=6
*
READ (5) VIEWEMP BY NAME STARTING FROM 'JONES'
  DISPLAY NAME (LC=*)
  FIRST-NAME (TC=*)
  SALARY (1:1) (IC=$)
  BONUS (1:1,1:1) (LC=>)
END-READ
END
```

The above program produces the following output. Compare the layout of this output with that of the previous program to see the effect of the individual parameters:

|        |            |                  |       |          |          |
|--------|------------|------------------|-------|----------|----------|
| Page   | 1          |                  |       | 04-11-11 | 11:11:11 |
| NAME   | FIRST-NAME | ANNUAL<br>SALARY | BONUS |          |          |
| -----  | -----      | -----            | ----- |          |          |
| *JONES | VIRGINIA   | * \$46000 >      | 9000  |          |          |
| *JONES | MARSHA     | * \$50000 >      | 0     |          |          |
| *JONES | ROBERT     | * \$31000 >      | 0     |          |          |
| *JONES | LILLY      | * \$24000 >      | 0     |          |          |
| *JONES | EDWARD     | * \$37600 >      | 0     |          |          |

As you can see in the above example, any output length you specify with the AL or NL parameter does not include any characters specified with the LC, IC and TC parameters: the width of the NAME column, for example, is 11 characters - 10 for the field value (AL=10) plus 1 leading character.

The width of the SALARY and BONUS columns is 8 characters - 6 for the field value (NL=6), plus 1 leading/inserted character, plus 1 sign position (because SG=ON applies).

## Identical Suppress - IS Parameter

With the session parameter IS, you can suppress the display of identical information in successive lines created by a WRITE or DISPLAY statement.

- By default, IS=OFF applies, which means that identical field values will be displayed.
- If IS=ON is specified, a value which is identical to the previous value of that field will not be displayed.

The IS parameter can be specified

- with a FORMAT statement to apply to the whole report, or
- in a DISPLAY or WRITE statement at both statement level and element level.

The effect of the parameter IS=ON can be suspended for one record by using the statement SUSPEND IDENTICAL SUPPRESS; see the *Statements* documentation for details.

Compare the output of the following two example programs to see the effect of the IS parameter. In the second one, the display of identical values in the NAME field is suppressed.

### Example Program without IS Parameter

```
** Example 'FORMAX05': FORMAT (without parameter IS
**                               and compare with FORMAX06)
*****
DEFINE DATA LOCAL
1 VIEWEMP VIEW OF EMPLOYEES
  2 NAME
  2 FIRST-NAME
END-DEFINE
*
READ (3) VIEWEMP BY NAME STARTING FROM 'JONES'
  DISPLAY NAME FIRST-NAME
END-READ
END
```

The above program produces the following output:

```
Page      1                                04-11-11  11:11:11

      NAME                FIRST-NAME
-----
JONES                VIRGINIA
JONES                MARSHA
JONES                ROBERT          ↵
```

### Example Program with IS Parameter

```
** Example 'FORMAX06': FORMAT (with parameter IS
**                               and compare with FORMAX05)
*****
DEFINE DATA LOCAL
1 VIEWEMP VIEW OF EMPLOYEES
  2 NAME
  2 FIRST-NAME
END-DEFINE
*
FORMAT IS=ON
*
READ (3) VIEWEMP BY NAME STARTING FROM 'JONES'
  DISPLAY NAME FIRST-NAME
END-READ
END
```

The above program produces the following output:

|       |      |                              |          |
|-------|------|------------------------------|----------|
| Page  | 1    | 04-11-11                     | 11:54:01 |
|       | NAME | FIRST-NAME                   |          |
| ----- |      |                              |          |
| JONES |      | VIRGINIA<br>MARSHA<br>ROBERT |          |

## Zero Printing - ZP Parameter

With the profile and session parameter `ZP`, you determine how a field value of zero is to be displayed.

- By default, `ZP=ON` applies, which means that one 0 (for numeric fields) or all zeros (for time fields) will be displayed for each field value that is zero.
- If you specify `ZP=OFF`, the display of each field value which is zero will be suppressed.

The `ZP` parameter can be specified

- with a `FORMAT` statement to apply to the whole report, or
- in a `DISPLAY` or `WRITE` statement at both statement level and element level.

Compare the output of the following two [example programs](#) to see the effect of the parameters `ZP` and `ES`.

## Empty Line Suppression - ES Parameter

With the session parameter `ES`, you can suppress the output of empty lines created by a `DISPLAY` or `WRITE` statement.

- By default, `ES=OFF` applies, which means that lines containing all blank values will be displayed.
- If `ES=ON` is specified, a line resulting from a `DISPLAY` or `WRITE` statement which contains all blank values will not be displayed. This is particularly useful when displaying multiple-value fields or fields which are part of a periodic group if a large number of empty lines are likely to be produced.

The `ES` parameter can be specified

- with a `FORMAT` statement to apply to the whole report, or
- in a `DISPLAY` or `WRITE` statement at statement level.



**Note:** To achieve empty suppression for numeric values, in addition to ES=ON the parameter ZP=OFF must also be set for the fields concerned in order to have null values turned into blanks and thus not output either.

Compare the output of the following two example programs to see the effect of the parameters ZP and ES.

### Example Program without Parameters ZP and ES

```
** Example 'FORMAX07': FORMAT (without parameter ES and ZP
**                               and compare with FORMAX08)
*****
DEFINE DATA LOCAL
1 VIEWEMP VIEW OF EMPLOYEES
  2 NAME
  2 FIRST-NAME
  2 BONUS (1:2,1:1)
END-DEFINE
*
READ (4) VIEWEMP BY NAME STARTING FROM 'JONES'
  DISPLAY NAME FIRST-NAME BONUS (1:2,1:1)
END-READ
END
```

The above program produces the following output:

|       |      |            |          |          |
|-------|------|------------|----------|----------|
| Page  | 1    |            | 04-11-11 | 11:58:23 |
|       | NAME | FIRST-NAME | BONUS    |          |
| ----- |      |            |          |          |
| JONES |      | VIRGINIA   | 9000     |          |
|       |      |            | 6750     |          |
| JONES |      | MARSHA     | 0        |          |
|       |      |            | 0        |          |
| JONES |      | ROBERT     | 0        |          |
|       |      |            | 0        |          |
| JONES |      | LILLY      | 0        |          |
|       |      |            | 0        |          |

## Example Program with Parameters ZP and ES

```

** Example 'FORMAX08': FORMAT (with parameters ES and ZP
**                               and compare with FORMAX07)
*****
DEFINE DATA LOCAL
1 VIEWEMP VIEW OF EMPLOYEES
  2 NAME
  2 FIRST-NAME
  2 BONUS (1:2,1:1)
END-DEFINE
*
FORMAT ES=ON
*
READ (4) VIEWEMP BY NAME STARTING FROM 'JONES'
  DISPLAY NAME FIRST-NAME BONUS (1:2,1:1)(ZP=OFF)
END-READ
END

```

The above program produces the following output:

| NAME  | FIRST-NAME | BONUS |
|-------|------------|-------|
| JONES | VIRGINIA   | 9000  |
| JONES | MARSHA     | 6750  |
| JONES | ROBERT     |       |
| JONES | LILLY      |       |

## Further Examples of Field-Output-Relevant Parameters

For further examples of the parameters LC, IC, TC, AL, NL, IS, ZP and ES, and the SUSPEND IDENTICAL SUPPRESS statement, see the following example programs:

- **DISPLX17 - DISPLAY** (with NL, AL, IC, LC, TC)
- **DISPLX18 - DISPLAY** (using default settings for SF, AL, UC, LC, IC, TC and compare with DISPLX19)
- **DISPLX19 - DISPLAY** (with SF, AL, LC, IC, TC and compare with DISPLX18)
- **SUSPEX01 - SUSPEND IDENTICAL SUPPRESS** (in conjunction with parameters IS, ES, ZP in DISPLAY)
- **SUSPEX02 - SUSPEND IDENTICAL SUPPRESS** (in conjunction with parameters IS, ES, ZP in DISPLAY). Identical to SUSPEX01, but with IS=OFF.

■ *COMPRX03 - COMPRESS*



# 32

## Code Page Edit Masks - EM Parameter

---

|                                                  |     |
|--------------------------------------------------|-----|
| ■ Use of EM Parameter .....                      | 316 |
| ■ Edit Masks for Numeric Fields .....            | 316 |
| ■ Edit Masks for Alphanumeric Fields .....       | 317 |
| ■ Length of Fields .....                         | 317 |
| ■ Edit Masks for Date and Time Fields .....      | 318 |
| ■ Customizing Separator Character Displays ..... | 318 |
| ■ Examples of Edit Masks .....                   | 320 |
| ■ Further Examples of Edit Masks .....           | 322 |

This chapter describes how you can specify an edit mask for an alphanumeric or numeric field.

## Use of EM Parameter

---

With the session parameter `EM` you can specify an edit mask for an alphanumeric or numeric field, that is, determine character by character the format in which the field values are to be output. Using the session parameter `EMU`, you can define edit masks with Unicode characters in the same way as described below for the `EM` session parameter.

Example:

```
DISPLAY NAME (EM=X^X^X^X^X^X^X^X^X^X)
```

In this example, each `X` represents one character of an alphanumeric field value to be displayed, and each `^` represents a blank. If displayed via the `DISPLAY` statement, the name `JOHNSON` would appear as follows:

```
J O H N S O N
```

You can specify the session parameter `EM`

- at report level (in a `FORMAT` statement),
- at statement level (in a `DISPLAY`, `WRITE`, `INPUT`, `MOVE EDITED` or `PRINT` statement) or
- at element level (in a `DISPLAY`, `WRITE` or `INPUT` statement).

An edit mask specified with the session parameter `EM` will override a default edit mask specified for a field in the `DDM`.

If `EM=OFF` is specified, no edit mask at all will be used.

An edit mask specified at statement level will override an edit mask specified at report level.

An edit mask specified at element level will override an edit mask specified at statement level.

## Edit Masks for Numeric Fields

---

An edit mask specified for a field of format `N`, `P`, `I`, or `F` must contain at least one `9` or `Z`. If more nines or `Zs` exist, the number of positions contained in the field value, the number of print positions in the edit mask will be adjusted to the number of digits defined for the field value. If fewer nines or `Zs` exist, the high-order digits before the decimal point and/or low-order digits after the decimal point will be truncated.

For further information, see session parameter EM, *Edit Masks for Numeric Fields* in the *Parameter Reference* documentation.

## Edit Masks for Alphanumeric Fields

Edit masks for alphanumeric fields must include an X for each alphanumeric character that is to be output.

With a few exceptions, you may add leading, trailing and insertion characters (with or without enclosing them in apostrophes).

The circumflex character (^) is used to insert blanks in edit mask for both numeric and alphanumeric fields.

For further information, see session parameter EM, *Edit Masks for Alphanumeric Fields* in the *Parameter Reference* documentation.

## Length of Fields

It is important to be aware of the length of the field to which you assign an edit mask.

- If the edit mask is longer than the field, this will yield unexpected results.
- If the edit mask is shorter than the field, the field output will be truncated to just those positions specified in the edit mask.

### Examples:

Assuming an alphanumeric field that is 12 characters long and the field value to be output is JOHNSON, the following edit masks will yield the following results:

| Edit Mask           | Output        |
|---------------------|---------------|
| EM=X.X.X.X.X        | J.O.H.N.S     |
| EM=*****XXXXXX***** | *****JOHNSO** |

## Edit Masks for Date and Time Fields

---

Edit masks for date fields can include the characters **D** (day), **M** (month) and **Y** (year) in various combinations.

Edit masks for time fields can include the characters **H** (hour), **I** (minute), **S** (second) and **T** (tenth of a second) in various combinations.

In conjunction with edit masks for date and time fields, see also the date and time system variables.

## Customizing Separator Character Displays

---

Natural programs are used in business applications all over the world. Depending on the local conventions, it is usual to present numeric data fields and those with a date or time content in a special output style, when displayed in I/O statements. The different appearance should not be realized by alternate program coding that is processed selectively as a function of the locale where the program is being executed, but should be carried out with the same program image in conjunction with a set of runtime parameters to specify the decimal point character and the “thousands separator character”.

The following topics are covered below:

- [Decimal Separator](#)
- [Dynamic Thousands Separator](#)
- [Examples](#)

### Decimal Separator

The Natural parameter **DC** is available to specify the character to be inserted in place of any characters used to represent the decimal separator (also called “radix” character) in edit masks. This parameter enables the users of a Natural program or application to choose any (special) character to separate the integer positions from the decimal positions of a numeric data item and enables, for example, U.S. shops to use the decimal point (.) and European shops to use the comma (,).

## Dynamic Thousands Separator

To structure the output of a large integer values, it is common practice to insert separators between every three digits of an integer to separate groups of thousands. This separator is called a “thousands separator”. For example, shops in the United States generally use a comma for this purpose (1,000,000), whereas shops in Germany use the period (1.000.000), in France a space (1 000 000), etc.

In a Natural edit mask, a “dynamic thousands separator” is a comma (or period) indicating the position where thousands separator characters (defined with the THSEPCH parameter) are inserted at runtime. At compile time, the Natural profile parameter THSEP or the option THSEP of system command COMPOPT enables or disables the interpretation of the comma (or period) as dynamic thousands separator.

If THSEP is set to OFF (default), any character used as thousands separator in the edit mask is treated as literal and displayed unchanged at runtime. This setting retains downwards compatibility.

If THSEP is set to ON, any comma (or period) in the edit mask is interpreted as dynamic thousands separators. In general, the dynamic thousands separator is a comma, but if the comma is already in use as decimal character (DC), the period is used as dynamic thousands separator.

At runtime the dynamic thousands separators are replaced by the current value of the THSEPCH parameter (thousands separator character).

### Examples

A Natural program that is cataloged with parameter settings DC='.' and THSEP=ON uses the edit mask (EM=ZZ,ZZZ,ZZ9.99).

| Parameter Settings at Runtime | Displays as  |
|-------------------------------|--------------|
| DC='.' and THSEPCH=','        | 1,234,567.89 |
| DC=',' and THSEPCH='.'        | 1.234.567,89 |
| DC=',' and THSEPCH='/'        | 1/234/567,89 |
| DC=',' and THSEPCH=' '        | 1 234 567,89 |
| DC=',' and THSEPCH=''''       | 1'234'567,89 |

## Examples of Edit Masks

Some examples of edit masks, along with possible output they produce, are provided below.

In addition, the abbreviated notation for each edit mask is given. You can use either the abbreviated or the long notation.

| Edit Mask     | Abbreviation   | Output A   | Output B   |
|---------------|----------------|------------|------------|
| EM=999.99     | EM=9(3).9(2)   | 367.32     | 005.40     |
| EM=ZZZZZ9     | EM=Z(5)9(1)    | 0          | 579        |
| EM=X^XXXXX    | EM=X(1)^X(5)   | B LUE      | A 19379    |
| EM=XXX...XX   | EM=X(3)...X(2) | BLU...E    | AAB...01   |
| EM=MM.DD.YY   | *              | 01.05.87   | 12.22.86   |
| EM=HH.II.SS.T | **             | 08.54.12.7 | 14.32.54.3 |

\* Use a date system variable.

\*\* Use a time system variable.

For further information about edit masks, see the session parameter EM in the *Parameter Reference*.

### Example Program without EM Parameters

```
** Example 'EDITMX01': Edit mask (using default edit masks)
*****
DEFINE DATA LOCAL
1 VIEWEMP VIEW OF EMPLOYEES
  2 NAME
  2 JOB-TITLE
  2 SALARY (1:3)
  2 CITY
END-DEFINE
*
READ (3) VIEWEMP BY NAME STARTING FROM 'JONES'
  DISPLAY 'N A M E'      NAME      /
          'OCCUPATION'  JOB-TITLE
          'SALARY'      SALARY (1:3)
          'LOCATION'     CITY
  SKIP 1
END-READ
END
```

Output of Program EDITMX01:

The output of this program shows the default edit masks available.

|       |                       |                         |           |          |
|-------|-----------------------|-------------------------|-----------|----------|
| Page  | 1                     |                         | 04-11-11  | 14:15:54 |
|       | N A M E<br>OCCUPATION | SALARY                  | LOCATION  |          |
| ----- |                       |                         |           |          |
|       | JONES<br>MANAGER      | 46000<br>42300<br>39300 | TULSA     |          |
|       | JONES<br>DIRECTOR     | 50000<br>46000<br>42700 | MOBILE    |          |
|       | JONES<br>PROGRAMMER   | 31000<br>29400<br>27600 | MILWAUKEE |          |

### Example Program with EM Parameters

```

** Example 'EDITMX02': Edit mask (using EM)
*****
DEFINE DATA LOCAL
1 VIEWEMP VIEW OF EMPLOYEES
  2 NAME
  2 FIRST-NAME
  2 JOB-TITLE
  2 SALARY (1:3)
END-DEFINE
*
READ (3) VIEWEMP BY NAME STARTING FROM 'JONES'
  DISPLAY 'N A M E'      NAME          (EM=X^X^X^X^X^X^X^X^X^X^X^X^X^X^X^X^X^X) /
                FIRST-NAME      (EM=...X(10)...)
                'OCCUPATION' JOB-TITLE (EM=' ____ 'X(12))
                'SALARY'      SALARY (1:3) (EM=' USD 'ZZZ,999)
  SKIP 1
END-READ
END

```

### Output of Program EDITMX02:

Compare the output with that of the previous program ([Example Program without EM Parameters](#)) to see how the EM specifications affect the way the fields are displayed.

|            |                       |                |            |          |          |
|------------|-----------------------|----------------|------------|----------|----------|
| Page       | 1                     |                |            | 04-11-11 | 14:15:54 |
|            | N A M E<br>FIRST-NAME | OCCUPATION     | SALARY     |          |          |
| -----      |                       |                |            |          |          |
| J O N E S  |                       | ___ MANAGER    | USD 46,000 |          |          |
| ..VIRGINIA | ...                   |                | USD 42,300 |          |          |
|            |                       |                | USD 39,300 |          |          |
| J O N E S  |                       | ___ DIRECTOR   | USD 50,000 |          |          |
| ..MARSHA   | ...                   |                | USD 46,000 |          |          |
|            |                       |                | USD 42,700 |          |          |
| J O N E S  |                       | ___ PROGRAMMER | USD 31,000 |          |          |
| ..ROBERT   | ...                   |                | USD 29,400 |          |          |
|            |                       |                | USD 27,600 |          |          |

## Further Examples of Edit Masks

---

See the following example programs:

- *EDITMX03 - Edit mask (different EM for alpha-numeric fields)*
- *EDITMX04 - Edit mask (different EM for numeric fields)*
- *EDITMX05 - Edit mask (EM for date and time system variables)*



# 33

## Unicode Edit Masks - EMU Parameter

---

Unicode edit masks can be used similar to code page edit masks. The difference is that the edit mask is always stored in Unicode format.

This allows you to specify edit masks with mixed characters from different code pages and assures that always the correct character is displayed, independent of the installed system code page.

For the general usage of edit masks, see [Edit Masks - EM Parameter](#).

For information on the session parameter EMU, see [EMU - Unicode Edit Mask](#) (in the *Parameter Reference*).



# 34 Vertical Displays

---

- Creating Vertical Displays ..... 326
- Combining DISPLAY and WRITE ..... 326
- Tab Notation - T\*field ..... 327
- Positioning Notation x/y ..... 328
- DISPLAY VERT Statement ..... 329
- Further Example of DISPLAY VERT with WRITE Statement ..... 335

This chapter describes how you can combine the features of the statements `DISPLAY` and `WRITE` to produce vertical displays of field values.

## Creating Vertical Displays

---

There are two ways of creating vertical displays:

- You can use a combination of the statements `DISPLAY` and `WRITE`.
- You can use the `VERT` option of the `DISPLAY` statement.

## Combining `DISPLAY` and `WRITE`

---

As described in *Statements `DISPLAY` and `WRITE`*, the `DISPLAY` statement normally presents the data in columns with default headers, while the `WRITE` statement presents data horizontally without headers.

You can combine the features of the two statements to produce vertical displays of field values.

The `DISPLAY` statement produces the values of different fields for the same record across the page with a column for each field. The field values for each record are displayed below the values for the previous record.

By using a `WRITE` statement after a `DISPLAY` statement, you can insert text and/or field values specified in the `WRITE` statement between records displayed via the `DISPLAY` statement.

The following program illustrates the combination of `DISPLAY` and `WRITE`:

```
** Example 'WRITEX04': WRITE (in combination with DISPLAY)
*****
DEFINE DATA LOCAL
1 VIEWEMP VIEW OF EMPLOYEES
  2 NAME
  2 JOB-TITLE
  2 CITY
  2 DEPT
END-DEFINE
*
READ (3) VIEWEMP BY CITY STARTING FROM 'SAN FRANCISCO'
  DISPLAY NAME JOB-TITLE
  WRITE 22T 'DEPT:' DEPT
  SKIP 1
END-READ
END
```

## Output of Program WRITEX04:

```

Page      1                                     04-11-11  14:15:55
      NAME                                CURRENT
                                POSITION
-----
KOLENCE                                MANAGER
                                DEPT: TECH05
GOSDEN                                  ANALYST
                                DEPT: TECH10
WALLACE                                SALES PERSON
                                DEPT: SALE20

```

## Tab Notation - T\*field

In the previous example, the position of the field DEPT is determined by the tab notation *nT* (in this case 20T, which means that the display begins in column 20 on the screen).

Field values specified in a WRITE statement can be lined up automatically with field values specified in the first DISPLAY statement of the program by using the tab notation *T\*field* (where *field* is the name of the field to which the field is to be aligned).

In the following program, the output produced by the WRITE statement is aligned to the field JOB-TITLE by using the notation *T\*JOB-TITLE*:

```

** Example 'WRITEX05': WRITE (in combination with DISPLAY)
*****
DEFINE DATA LOCAL
1 VIEWEMP VIEW OF EMPLOYEES
  2 NAME
  2 JOB-TITLE
  2 DEPT
  2 CITY
END-DEFINE
*
READ (3) VIEWEMP BY CITY STARTING FROM 'SAN FRANCISCO'
  DISPLAY NAME JOB-TITLE
  WRITE T*JOB-TITLE 'DEPT:' DEPT
  SKIP 1
END-READ
END

```

## Output of Program WRITEX05:

Page 1 04-11-11 14:15:55

| NAME    | CURRENT<br>POSITION          |
|---------|------------------------------|
| KOLENCE | MANAGER<br>DEPT: TECH05      |
| GOSDEN  | ANALYST<br>DEPT: TECH10      |
| WALLACE | SALES PERSON<br>DEPT: SALE20 |

## Positioning Notation x/y

When you use the `DISPLAY` and `WRITE` statements in sequence and multiple lines are to be produced by the `WRITE` statement, you can use the notation `x/y` (number-slash-number) to determine in which row/column something is to be displayed. The positioning notation causes the next element in the `DISPLAY` or `WRITE` statement to be placed `x` lines below the last output, beginning in column `y` of the output.

The following program illustrates the use of this notation:

```
** Example 'WRITEX06': WRITE (with n/n)
*****
DEFINE DATA LOCAL
1 VIEWEMP VIEW OF EMPLOYEES
  2 NAME
  2 FIRST-NAME
  2 MIDDLE-I
  2 ADDRESS-LINE (1:1)
  2 CITY
  2 ZIP
END-DEFINE
*
READ (3) VIEWEMP BY CITY STARTING FROM 'NEW YORK'
  DISPLAY 'NAME AND ADDRESS' NAME
  WRITE 1/5 FIRST-NAME
        1/30 MIDDLE-I
        2/5 ADDRESS-LINE (1:1)
        3/5 CITY
        3/30 ZIP /
END-READ
END
```

Output of Program WRITEX06:

```
Page      1                                04-11-11  14:15:55
NAME AND ADDRESS
-----
RUBIN
  SYLVIA                L
  2003 SARAZEN PLACE
  NEW YORK              10036

WALLACE
  MARY                  P
  12248 LAUREL GLADE C
  NEW YORK              10036

KELLOGG
  HENRIETTA            S
  1001 JEFF RYAN DR.
  NEWARK                19711
```

## DISPLAY VERT Statement

---

The standard display mode in Natural is horizontal.

With the `VERT` clause option of the `DISPLAY` statement, you can override the standard display and produce a vertical field display.

The `HORIZ` clause option, which can be used in the same `DISPLAY` statement, re-activates the standard horizontal display mode.

Column headings in vertical mode are controlled with various forms of the `AS` clause. The following example programs illustrate the use of the `DISPLAY VERT` statement:

- `DISPLAY VERT` without `AS` Clause
- `DISPLAY` with `VERT AS CAPTIONED` and `HORIZ` Clause
- `DISPLAY` with `VERT AS 'text'` Clause
- `DISPLAY` with `VERT AS 'text' CAPTIONED` Clause

- Tab Notation P\*field

## DISPLAY VERT without AS Clause

The following program has no AS clause, which means that no column headings are output.

```
** Example 'DISPLX09': DISPLAY (without column title)
*****
DEFINE DATA LOCAL
1 VIEWEMP VIEW OF EMPLOYEES
  2 NAME
  2 FIRST-NAME
  2 CITY
END-DEFINE
*
READ (3) VIEWEMP BY CITY STARTING FROM 'NEW YORK'
  DISPLAY VERT NAME FIRST-NAME / CITY
  SKIP 2
END-READ
END
```

Output of Program DISPLX09:

Note that all field values are displayed vertically underneath one another.

```
Page      1                                04-11-11  14:15:54

RUBIN
SYLVIA

NEW YORK

WALLACE
MARY

NEW YORK

KELLOGG
HENRIETTA

NEWARK
```



## DISPLAY with VERT AS CAPTIONED and HORIZ Clause

The following program contains a VERT and a HORIZ clause, which causes some column values to be output vertically and others horizontally; moreover AS CAPTIONED causes the default column headers to be displayed.

```
** Example 'DISPLX10': DISPLAY (with VERT as CAPTIONED and HORIZ clause)
*****
DEFINE DATA LOCAL
1 VIEWEMP VIEW OF EMPLOYEES
  2 NAME
  2 FIRST-NAME
  2 CITY
  2 JOB-TITLE
  2 SALARY (1:1)
END-DEFINE
*
READ (3) VIEWEMP BY CITY STARTING FROM 'NEW YORK'
  DISPLAY VERT AS CAPTIONED NAME FIRST-NAME
          HORIZ JOB-TITLE SALARY (1:1)
  SKIP 1
END-READ
END
```

Output of Program DISPLX10:

```
Page      1                                04-11-11  14:15:54

      NAME                CURRENT          ANNUAL
      FIRST-NAME          POSITION           SALARY
-----
RUBIN                SECRETARY                17000
SYLVIA

WALLACE              ANALYST                  38000
MARY

KELLOGG              DIRECTOR                  52000
HENRIETTA
```

### DISPLAY with VERT AS 'text' Clause

The following program contains an AS 'text' clause, which displays the specified 'text' as column header.



**Note:** A slash (/) within the text element in a DISPLAY statement causes a line advance.

```

** Example 'DISPLX11': DISPLAY (with VERT AS 'text' clause)
*****
DEFINE DATA LOCAL
1 VIEWEMP VIEW OF EMPLOYEES
  2 NAME
  2 FIRST-NAME
  2 CITY
  2 JOB-TITLE
  2 SALARY (1:1)
END-DEFINE
*
READ (3) VIEWEMP BY CITY STARTING FROM 'NEW YORK'
  DISPLAY VERT AS 'EMPLOYEES' NAME FIRST-NAME
          HORIZ JOB-TITLE SALARY (1:1)
  SKIP 1
END-READ
END
    
```

### Output of Program DISPLX11:

| EMPLOYEES         | CURRENT POSITION | ANNUAL SALARY |
|-------------------|------------------|---------------|
| RUBIN SYLVIA      | SECRETARY        | 17000         |
| WALLACE MARY      | ANALYST          | 38000         |
| KELLOGG HENRIETTA | DIRECTOR         | 52000         |

**DISPLAY with VERT AS 'text' CAPTIONED Clause**

The AS '*text*' CAPTIONED clause causes the specified text to be displayed as column heading, and the default column headings to be displayed immediately before the field value in each line that is output.

The following program contains an AS '*text*' CAPTIONED clause.

```
** Example 'DISPLX12': DISPLAY (with VERT AS 'text' CAPTIONED clause)
*****
DEFINE DATA LOCAL
1 VIEWEMP VIEW OF EMPLOYEES
  2 NAME
  2 FIRST-NAME
  2 CITY
  2 JOB-TITLE
  2 SALARY (1:1)
END-DEFINE
*
READ (3) VIEWEMP BY CITY STARTING FROM 'NEW YORK'
  DISPLAY VERT AS 'EMPLOYEES' CAPTIONED NAME FIRST-NAME
  HORIZ JOB-TITLE SALARY (1:1)
  SKIP 1
END-READ
END
```

Output of Program DISPLX12:

This clause causes the default column headers (NAME and FIRST-NAME) to be placed before the field values:

| Page                                 | 1 | 04-11-11            | 14:15:54         |
|--------------------------------------|---|---------------------|------------------|
| EMPLOYEES                            |   | CURRENT<br>POSITION | ANNUAL<br>SALARY |
| -----                                |   |                     |                  |
| NAME RUBIN<br>FIRST-NAME SYLVIA      |   | SECRETARY           | 17000            |
| NAME WALLACE<br>FIRST-NAME MARY      |   | ANALYST             | 38000            |
| NAME KELLOGG<br>FIRST-NAME HENRIETTA |   | DIRECTOR            | 52000            |

### Tab Notation P\*field

If you use a combination of DISPLAY VERT statement and subsequent WRITE statement, you can use the tab notation *P\*field-name* in the WRITE statement to align the position of a field to the column *and* line position of a particular field specified in the DISPLAY VERT statement.

In the following program, the fields SALARY and BONUS are displayed in the same column, SALARY in every first line, BONUS in every second line. The text **\*\*\*SALARY PLUS BONUS\*\*\*** is aligned to SALARY, which means that it is displayed in the same column as SALARY and in the first line, whereas the text **(IN US DOLLARS)** is aligned to BONUS and therefore displayed in the same column as BONUS and in the second line.

```

** Example 'WRITEX07': WRITE (with P*field)
*****
DEFINE DATA LOCAL
1 VIEWEMP VIEW OF EMPLOYEES
  2 CITY
  2 NAME
  2 JOB-TITLE
  2 SALARY (1:1)
  2 BONUS (1:1,1:1)
END-DEFINE
*
READ (3) VIEWEMP BY CITY STARTING FROM 'LOS ANGELES'
  DISPLAY NAME JOB-TITLE
           VERT AS 'INCOME' SALARY (1) BONUS (1,1)
  WRITE P*SALARY '***SALARY PLUS BONUS***'
         P*BONUS '(IN US DOLLARS)'
  SKIP 1
END-READ
END
    
```

### Output of Program WRITEX07:

|      |          |                  |                         |          |
|------|----------|------------------|-------------------------|----------|
| Page | 1        |                  | 04-11-11                | 14:15:55 |
|      | NAME     | CURRENT POSITION | INCOME                  |          |
|      | -----    |                  |                         |          |
|      | SMITH    |                  | 0                       |          |
|      |          |                  | 0                       |          |
|      |          |                  | ***SALARY PLUS BONUS*** |          |
|      |          |                  | (IN US DOLLARS)         |          |
|      | POORE JR | SECRETARY        | 25000                   |          |
|      |          |                  | 0                       |          |
|      |          |                  | ***SALARY PLUS BONUS*** |          |
|      |          |                  | (IN US DOLLARS)         |          |

---

```
PREPARATA          MANAGER          46000
                   9000
                   ***SALARY PLUS BONUS***
                   (IN US DOLLARS)
```

## Further Example of DISPLAY VERT with WRITE Statement

---

See the following example program:

- *WRITEX10 - WRITE (with nT, T\*field and P\*field)*



# VII Further Programming Aspects

---

End of Statement, Program or Application

Processing of Application Errors

Conditional Processing - IF Statement

Loop Processing

Control Breaks

Data Computation

System Variables and System Functions

Stack

Processing of Date Information

Text Notation

User Comments

Logical Condition Criteria

Rules for Arithmetic Assignment

Invoking Natural Subprograms from 3GL Programs

Issuing Operating System Commands from within a Natural Program

Statements for Internet and XML Access





# 35

## End of Statement, Program or Application

---

|                            |     |
|----------------------------|-----|
| ▪ End of Statement .....   | 340 |
| ▪ End of Program .....     | 340 |
| ▪ End of Application ..... | 340 |

## End of Statement

---

To explicitly mark the end of a statement, you can place a semicolon (;) between the statement and the next statement. This can be used to make the program structure clearer, but is not required.

## End of Program

---

The `END` statement is used to mark the end of a Natural program, function, subprogram, external subroutine or help routine.

Every one of these objects must contain an `END` statement as the last statement.

Every object may contain only one `END` statement.

## End of Application

---

### Ending the Execution of an Application by a `STOP` Statement

The `STOP` statement is used to terminate the execution of a Natural application. A `STOP` statement executed anywhere within an application immediately stops the execution of the entire application.

### Ending the Execution of an Application by a `TERMINATE` Statement

The `TERMINATE` statement stops the execution of the Natural application and also ends the Natural session.

### Interrupting a Running Natural Application

During the development of a Natural application and in test situations, the user should be able to interrupt a running Natural application that does not respond anymore, for example, due to an endless loop. As the Natural session should not need to be killed, the running Natural application can be interrupted via the typical system interrupt key combination (for example, `CTRL+BREAK` for Windows, `CTRL+C` for UNIX and OpenVMS). The Natural error `NAT1016` is raised and the runtime error processing is activated. The error can be handled by an `ON ERROR` processing.

In a production environment, this feature will typically need to be disabled, because the application may not be able to recover from a user interrupt at an arbitrary program location.

The Natural profile parameter `RTINT` determines whether interrupts are allowed. By default, interrupts are not allowed.

If this parameter is set to `ON`, a running Natural application may be interrupted with the interrupt key combination of the operating system (for example, for Windows: `CTRL+BREAK`; for UNIX: typically `CTRL+C`, but can be reconfigured using the `stty` command; for OpenVMS: `CTRL+C`).

Natural catches this interrupt request and then offers the user the following possibilities:

- Perform standard error processing by raising a NAT1016 error.
- Continue application processing (cancel interrupt).

The choice is shown in a window that is opened after catching the interrupt signal.



# 36 Processing of Application Errors

---

- Natural's Default Error Processing ..... 344
- Application Specific Error Processing ..... 344
- Using an ON ERROR Statement Block ..... 345
- Using an Error Transaction Program ..... 346
- Error Processing Related Features ..... 349

This section discusses the two basic methods Natural offers for the handling of application errors: default processing and application-specific processing. Furthermore, it describes the options you have to enable the application specific error processing: coding an `ON ERROR` statement block within a programming object or using a separate error transaction program.

Finally, this section gives an overview of the features that are provided to configure Natural's error processing behavior, to retrieve information on an error, to process or debug an application error.

This document covers the following topics:

For information on error handling in a Natural RPC environment, see *Handling Errors* in the *Natural Remote Procedure Call* documentation.

## Natural's Default Error Processing

---

When an error occurs in a Natural application, Natural will by default proceed in the following way:

1. Natural terminates the execution of the currently running application object;
2. Natural issues an error message;
3. Natural returns to command input mode.

“Command input mode” means that, depending on your Natural configuration, the Natural main menu, the `NEXT` command prompt, or a user-defined startup menu may appear.

The displayed error message contains the Natural error number, the corresponding message text and the affected Natural object and line number where the error has occurred.

Because after the occurrence of an error the execution of the affected application object is terminated, the status of any pending database transactions may be affected by actions required by the setting of the profile parameter `ETEOP`. Unless Natural has issued an `END TRANSACTION` statement as a result of the settings of these parameters, a `BACKOUT TRANSACTION` statement is issued when Natural returns to command input mode.

## Application Specific Error Processing

---

Natural enables you to adapt the error processing if the default error processing does not meet your application's requirements. Possible reasons to establish an application specific error processing may be:

- The information on the error is to be stored for further analysis by the application developer.
- The application execution is to be continued after error recovery, if possible.

- A specific transaction handling is necessary.

Because the execution of the affected Natural application object is terminated after an application error has occurred, the status of the pending database transactions may be influenced by actions which are triggered by the settings of the profile parameter `ETEOP`. Therefore, further transaction handling (`END TRANSACTION` or `BACKOUT TRANSACTION` statement) has to be performed by the application's error processing.

To enable the application specific error processing, you have the following options:

- You may code an `ON ERROR` statement block within a programming object.
- You may use a separate error transaction program.

These options are described in the following sections.

## Using an `ON ERROR` Statement Block

---

You may use the `ON ERROR` statement to intercept execution time errors within the application where an error occurs.

From within an `ON ERROR` statement block, it is possible to resume application execution on the current level or on a superior level.

Moreover, you may specify an `ON ERROR` statement in multiple objects of an application in order to process any errors that have occurred on subordinate levels. Thus, application specific error processing may exactly be tailored to the application's needs.

### Exiting from an `ON ERROR` Statement Block

You may exit from an `ON ERROR` statement block by specifying one of the following statements:

- `RETRY`

Application execution is resumed on the current level.

- `ESCAPE ROUTINE`

Error processing is assumed to be complete and application execution is resumed on the superior level.

- `FETCH`

Error processing is assumed to be complete and the "fetched" program is executed.

`STOP`

Natural stops the execution of the affected program, ends the application and returns to command input mode.

■ TERMINATE

The execution of the Natural application is stopped and also the Natural session is terminated.

### Error Processing Rules

- If the execution of the ON ERROR statement block is not terminated by one of these statements, the error is percolated to the Natural object on the superior level for processing by an ON ERROR statement block that exists there.
- If none of the Natural objects on any of the superior levels contains an ON ERROR statement block, but if an error transaction program has been specified (as described in the [next section](#)), this error transaction program will receive control.
- If none of the Natural objects on any of the superior levels contains an ON ERROR statement block and no error transaction program has been specified there, Natural's default error processing will be performed as described [above](#).

## Using an Error Transaction Program

---

You may specify an error transaction program in the following places:

- In the profile parameter ETA.
- If Natural Security is installed, within the Natural Security library profile; see *Components of a Library Profile* in the *Natural Security* documentation.
- Within a Natural object by assigning the name of the program which is to receive control in the event of an error condition as a value to the system variable \*ERROR-TA, using an ASSIGN, COMPUTE or MOVE statement.

If you assign the name of an error transaction program to the system variable \*ERROR-TA during the Natural session, this assignment supersedes an error transaction program specified using the profile parameter ETA. Regardless of whether you use the ETA profile parameter or assign a value to the system variable \*ERROR-TA, the error transaction program names are not saved and restored by Natural for different levels of the call hierarchy. Therefore, if you assign a name to the system variable \*ERROR-TA in a Natural object, the specified program will be invoked to process any error that occurs in the current Natural session after the assignment.

On the one hand, if you specify an error transaction program by using the profile parameter ETA, an error transaction is defined for the complete Natural session without having the need for individual assignments in Natural objects. On the other hand, the method of assigning a program to the system variable \*ERROR-TA provides more flexibility and, for example, allows you to have different error transaction programs in different application branches.



If the system variable \*ERROR-TA is reset to blank, Natural's default error processing will be performed as described [above](#).

If an error transaction program is specified and an application error occurs, execution of the application is terminated, and the specified error transaction program receives control to perform the following actions:

- Analyze the error;
- Log the error information;
- Terminate the Natural session;
- Continue the application execution by calling a program using the FETCH statement.

Because the error transaction program receives control in the same way as if it had been called from the command prompt, it is not possible to resume application execution in one of the Natural objects that were active at the time when the error occurred.

If a syntax error occurs and the Natural profile parameter SYNERR is set to ON, the error transaction program will also receive control.

An error transaction program must be located in the library to which you are currently logged on or in a current steplib library.

When an error occurs, Natural executes a STACK TOP DATA statement and places the following information at the top of the stack:

| Stack Data          | Format/Length | Description                                                                                                                                                                                    |                                                          |
|---------------------|---------------|------------------------------------------------------------------------------------------------------------------------------------------------------------------------------------------------|----------------------------------------------------------|
| <b>Error number</b> | N4            | Natural error number.<br><b>Note:</b> If session parameter SG is set to ON, the format/length will be N5.                                                                                      |                                                          |
| <b>Line number</b>  | N4            | Number of the line where the error has occurred.<br>If the status is C or L, the line number will be zero.                                                                                     |                                                          |
| <b>Status</b>       | A1            | Status code:                                                                                                                                                                                   |                                                          |
|                     |               | C                                                                                                                                                                                              | Command processing error                                 |
|                     |               | L                                                                                                                                                                                              | Logon processing error                                   |
|                     |               | O                                                                                                                                                                                              | Object (execution) time error                            |
|                     |               | R                                                                                                                                                                                              | Error on remote server (in conjunction with Natural RPC) |
|                     | S             | Syntax error                                                                                                                                                                                   |                                                          |
| <b>Object name</b>  | A8            | Name of the Natural object where the error has occurred.                                                                                                                                       |                                                          |
| <b>Level number</b> | N2            | Level number of the Natural object where the error has occurred.<br>If a Natural syntax error occurs at compile time and profile parameter SYNERR is set to ON, the level number will be zero. |                                                          |

| Stack Data                                                                                       | Format/Length | Description                                                                                                                                                                                                                |
|--------------------------------------------------------------------------------------------------|---------------|----------------------------------------------------------------------------------------------------------------------------------------------------------------------------------------------------------------------------|
|                                                                                                  |               | If a Natural runtime error occurs and the level number of the Natural object is greater than 99, the value 99 will be stacked, and the current value will be stacked in the additional stack data "Level number enhanced". |
| If a Natural runtime error occurs and the level number of the Natural object is greater than 99: |               |                                                                                                                                                                                                                            |
| <b>Level number enhanced</b>                                                                     | I4            | Current level number (512 at maximum).                                                                                                                                                                                     |
| If a Natural syntax error occurs at compile time and profile parameter SYNERR is set to ON:      |               |                                                                                                                                                                                                                            |
| <b>Error position</b>                                                                            | N3            | Position of the offending item in the source line.                                                                                                                                                                         |
| <b>Item length</b>                                                                               | N3            | Length of the offending item.                                                                                                                                                                                              |

This information can be retrieved in the error transaction program, using an INPUT statement.

Example:

```

DEFINE DATA LOCAL
1 #ERROR-NR          (N5)
1 #LINE             (N4)
1 #STATUS-CODE      (A1)
1 #PROGRAM          (A8)
1 #LEVEL           (N2)
1 #LEVELI4         (I4)
1 #POSITION-IN-LINE (N3)
1 #LENGTH-OF-ITEM  (N3)
END-DEFINE
IF *DATA > 6 THEN          /* SYNERR = ON and a syntax error occurred
  INPUT
  #ERROR-NR
  #LINE
  #STATUS-CODE
  #PROGRAM
  #LEVEL
  #POSITION-IN-LINE
  #LENGTH-OF-ITEM
ELSE
  INPUT                    /* other error
  #ERROR-NR
  #LINE
  #STATUS-CODE
  #PROGRAM
  #LEVEL
  #LEVELI4
END-IF
WRITE #STATUS-CODE
* DECIDE ON FIRST VALUE OF STATUS-CODE
* ... /* process error
* END-DECIDE
END

```

Some of the information placed on top of the stack is equivalent to the contents of several system variables that are available in an `ON ERROR` statement block:

| Stack Data          | Equivalent System Variable in ON ERROR Statement Block |
|---------------------|--------------------------------------------------------|
| <b>Error number</b> | *ERROR-NR                                              |
| <b>Line number</b>  | *ERROR-LINE                                            |
| <b>Object name</b>  | *PROGRAM                                               |
| <b>Level number</b> | *LEVEL                                                 |

### Rules under Natural Security

If Natural Security is installed, the additional rules for the processing of logon errors apply. For further information, see *Transactions* in the *Natural Security* documentation.

## Error Processing Related Features

Natural provides a variety of error processing related features that

- Enable you to configure Natural's error processing behavior;
- Help you in retrieving information about errors that have occurred;
- Support you in processing these errors;
- Support you in debugging application errors.

These features can be grouped as follows:

- **Profile parameters**
- **System variables**
- **Terminal Commands**
- **Application programming interfaces**

### Profile Parameters

The following profile parameters have an influence on the behavior of Natural in the event of an error:

| Profile Parameter | Purpose                                          |
|-------------------|--------------------------------------------------|
| CPCVERR           | Conversion Error                                 |
| ETA               | Error Transaction Program                        |
| ETEOP             | Issue END TRANSACTION at End of Program          |
| RCFIND            | Handling of Response Code 113 for FIND Statement |
| RCGET             | Handling of Response Code 113 for GET Statement  |
| SYNERR            | Control of Syntax Errors                         |

### System Variables

The following application related system variables can be used to locate an error or to obtain/specify the name of the program which is to receive control in the event of an error condition:

| System Variable | Content                                                                                                                |
|-----------------|------------------------------------------------------------------------------------------------------------------------|
| *ERROR-LINE     | Source-code line number of the statement that caused an error.<br>See <a href="#">Example 1</a> .                      |
| *ERROR-NR       | Error number of the error which caused an ON ERROR condition to be entered.                                            |
| *ERROR-TA       | Name of the program which is to receive control in the event of an error condition.<br>See <a href="#">Example 2</a> . |
| *LEVEL          | Level number of the Natural object where the error has occurred.                                                       |
| *LIBRARY-ID     | Name of the library to which the user is currently logged on.                                                          |
| *PROGRAM        | Name of the Natural object that is currently being executed.<br>See <a href="#">Example 1</a> .                        |

#### Example 1:

```

...
/*
ON ERROR
  IF *ERROR-NR = 3009 THEN
    WRITE 'LAST TRANSACTION NOT SUCCESSFUL'
      / 'HIT ENTER TO RESTART PROGRAM'
    FETCH 'ONEEX1'
  END-IF
  WRITE 'ERROR' *ERROR-NR 'OCCURRED IN PROGRAM' *PROGRAM
    'AT LINE' *ERROR-LINE
  FETCH 'MENU'
END-ERROR
/*
...

```

#### Example 2:

```

...
*ERROR-TA := 'ERRORTA1'
/* from now on, program ERRORTA1 will be invoked
/* to process application errors
...
MOVE 'ERRORTA2' TO *ERROR-TA
/* change error transaction program to ERRORTA2
...

```

For further information on these system variables, see the corresponding sections in the *System Variables* documentation.

### Terminal Commands

The following terminal command has an influence on the behavior of Natural in the event of an error:

| Terminal Command | Purpose                              |
|------------------|--------------------------------------|
| %E=              | Activate/Deactivate Error Processing |

### Application Programming Interfaces

The following application programming interfaces (APIs) are generally available for getting additional information on an error situation or to install an error transaction.

| API      | Purpose                                                  |
|----------|----------------------------------------------------------|
| USR0040N | Get type of last error                                   |
| USR1016N | Get error level for error in nested copycodes            |
| USR2001N | Get information on last error                            |
| USR2006N | Get information from error message collector             |
| USR2007N | Get or set data for RPC default server                   |
| USR2010N | Get error information on last database call              |
| USR2026N | Get TECH information                                     |
| USR2030N | Get dynamic error message parts from the last error      |
| USR3320N | Find user short error message (including steplib search) |
| USR4214N | Get program level information                            |



# 37 Conditional Processing - IF Statement

---

- Structure of IF Statement ..... 354
- Nested IF Statements ..... 356

With the IF statement, you define a logical condition, and the execution of the statement attached to the IF statement then depends on that condition.

## Structure of IF Statement

---

The IF statement contains three components:

|      |                                                                                                                     |
|------|---------------------------------------------------------------------------------------------------------------------|
| IF   | In the IF clause, you specify the logical condition which is to be met.                                             |
| THEN | In the THEN clause you specify the statement(s) to be executed if this condition is met.                            |
| ELSE | In the (optional) ELSE clause, you can specify the statement(s) to be executed if this condition is <i>not</i> met. |

So, an IF statement takes the following general form:

```
IF condition
  THEN execute statement(s)
  ELSE execute other statement(s)
END-IF
```



**Note:** If you wish a certain processing to be performed only if the IF condition is *not* met, you can specify the clause THEN IGNORE. The IGNORE statement causes the IF condition to be ignored if it is met.

### Example 1:

```
** Example 'IFX01': IF
*****
DEFINE DATA LOCAL
1 MYVIEW VIEW OF EMPLOYEES
  2 NAME
  2 BIRTH
  2 CITY
  2 SALARY (1:1)
END-DEFINE
*
LIMIT 7
READ MYVIEW BY CITY STARTING FROM 'C'
  IF SALARY (1) LT 40000 THEN
    WRITE NOTITLE '*****' NAME 30X 'SALARY LT 40000'
  ELSE
    DISPLAY NAME BIRTH (EM=YYYY-MM-DD) SALARY (1)
  END-IF
END-READ
END
```



The IF statement block in the above program causes the following conditional processing to be performed:

- IF the salary is less than 40000, THEN the WRITE statement is to be executed;
- otherwise (ELSE), that is, if the salary is 40000 or more, the DISPLAY statement is to be executed.

Output of Program IFX01:

| NAME            | DATE<br>OF<br>BIRTH | ANNUAL<br>SALARY |
|-----------------|---------------------|------------------|
| ***** KEEN      |                     | SALARY LT 40000  |
| ***** FORRESTER |                     | SALARY LT 40000  |
| ***** JONES     |                     | SALARY LT 40000  |
| ***** MELKANOFF |                     | SALARY LT 40000  |
| DAVENPORT       | 1948-12-25          | 42000            |
| GEORGES         | 1949-10-26          | 182800           |
| ***** FULLERTON |                     | SALARY LT 40000  |

### Example 2:

```

** Example 'IFX03': IF
*****
DEFINE DATA LOCAL
1 EMPLOY-VIEW VIEW OF EMPLOYEES
2 NAME
2 CITY
2 BONUS (1,1)
2 SALARY (1)
*
1 #INCOME (N9)
1 #TEXT (A26)
END-DEFINE
*
WRITE TITLE '-- DISTRIBUTION OF CATALOGS I AND II --' /
*
READ (3) EMPLOY-VIEW BY CITY = 'SAN FRANCISCO'
  COMPUTE #INCOME = BONUS(1,1) + SALARY(1)
  /*
  IF #INCOME > 40000
    MOVE 'CATALOGS I AND II' TO #TEXT
  ELSE
    MOVE 'CATALOG I'          TO #TEXT
  END-IF
  /*
  DISPLAY NAME 5X 'SALARY' SALARY(1) / BONUS(1,1)
  WRITE T*SALARY '-'(10) /
    16X 'INCOME:' T*SALARY #INCOME 3X #TEXT /

```

```
      16X '='(19)
      SKIP 1
      END-READ
      END
```

**Output of Program IFX03:**

```
      -- DISTRIBUTION OF CATALOGS I AND II --
      NAME                SALARY
                        BONUS
-----
COLVILLE JR            56000
                        0
                        -----
                        INCOME:    56000   CATALOGS I AND II
                        =====

RICHMOND                9150
                        0
                        -----
                        INCOME:    9150   CATALOG I
                        =====

MONKTON                 13500
                        600
                        -----
                        INCOME:    14100  CATALOG I
                        =====
```

## Nested IF Statements

---

It is possible to use various nested IF statements; for example, you can make the execution of a THEN clause dependent on another IF statement which you specify in the THEN clause.

**Example:**

```
** Example 'IFX02': IF (two IF statements nested)
*****
DEFINE DATA LOCAL
1 MYVIEW VIEW OF EMPLOYEES
  2 NAME
  2 CITY
  2 SALARY (1:1)
  2 BIRTH
  2 PERSONNEL-ID
1 MYVIEW2 VIEW OF VEHICLES
  2 PERSONNEL-ID
```

```

2 MAKE
*
1 #BIRTH (D)
END-DEFINE
*
MOVE EDITED '19450101' TO #BIRTH (EM=YYYYMMDD)
*
LIMIT 20
FND1. FIND MYVIEW WITH CITY = 'BOSTON'
        SORTED BY NAME
  IF SALARY (1) LESS THAN 20000
    WRITE NOTITLE '*****' NAME 30X 'SALARY LT 20000'
  ELSE
    IF BIRTH GT #BIRTH
      FIND MYVIEW2 WITH PERSONNEL-ID = PERSONNEL-ID (FND1.)
        DISPLAY (IS=ON) NAME BIRTH (EM=YYYY-MM-DD)
          SALARY (1) MAKE (AL=8 IS=OFF)
    END-FIND
  END-IF
END-IF
SKIP 1
END-FIND
END

```

**Output of Program IFX02:**

| NAME          | DATE<br>OF<br>BIRTH | ANNUAL<br>SALARY | MAKE             |
|---------------|---------------------|------------------|------------------|
| ***** COHEN   |                     |                  | SALARY LT 20000  |
| CREMER        | 1972-12-14          | 20000            | FORD             |
| ***** FLEMING |                     |                  | SALARY LT 20000  |
| PERREULT      | 1950-05-12          | 30500            | CHRYSLER         |
| ***** SHAW    |                     |                  | SALARY LT 20000  |
| STANWOOD      | 1946-09-08          | 31000            | CHRYSLER<br>FORD |



# 38

## Loop Processing

---

- Use of Processing Loops ..... 360
- Limiting Database Loops ..... 360
- Limiting Non-Database Loops - REPEAT Statement ..... 362
- Example of REPEAT Statement ..... 363
- Terminating a Processing Loop - ESCAPE Statement ..... 364
- Loops Within Loops ..... 364
- Example of Nested FIND Statements ..... 364
- Referencing Statements within a Program ..... 365
- Example of Referencing with Line Numbers ..... 367
- Example with Statement Reference Labels ..... 368

A processing loop is a group of statements which are executed repeatedly until a stated condition has been satisfied, or as long as a certain condition prevails.

## Use of Processing Loops

---

Processing loops can be subdivided into database loops and non-database loops:

- **Database processing loops**

are those created automatically by Natural to process data selected from a database as a result of a READ, FIND or HISTOGRAM statement. These statements are described in the section [Database Access](#).

- **Non-database processing loops**

are initiated by the statements REPEAT, FOR, CALL FILE, CALL LOOP, SORT, and READ WORK FILE.

More than one processing loop may be active at the same time. Loops may be embedded or nested within other loops which remain active (open).

A processing loop must be explicitly closed with a corresponding END- . . . statement (for example, END-REPEAT, END-FOR)

The SORT statement, which invokes the sort program of the operating system, closes all active processing loops and initiates a new processing loop.

## Limiting Database Loops

---

The following topics are covered below:

- [Possible Ways of Limiting Database Loops](#)
- [LT Session Parameter](#)
- [LIMIT Statement](#)
- [Limit Notation](#)

- Priority of Limit Settings

## Possible Ways of Limiting Database Loops

With the statements `READ`, `FIND` or `HISTOGRAM`, you have three ways of limiting the number of repetitions of the processing loops initiated with these statements:

- using the session parameter `LT`,
- using a `LIMIT` statement,
- or using a **limit notation** in a `READ/FIND/HISTOGRAM` statement itself.

### LT Session Parameter

At session level, you can specify the session parameter `LT`, which limits the number of records which may be read in a database processing loop.

#### Example:

```
GLOBALS LT=100
```

This limit applies to all `READ`, `FIND` and `HISTOGRAM` statements in the entire session.

### LIMIT Statement

In a program, you can use the `LIMIT` statement to limit the number of records which may be read in a database processing loop.

#### Example:

```
LIMIT 100
```

The `LIMIT` statement applies to the remainder of the program unless it is overridden by another `LIMIT` statement or limit notation.

### Limit Notation

With a `READ`, `FIND` or `HISTOGRAM` statement itself, you can specify the number of records to be read in parentheses immediately after the statement name.

**Example:**

```
READ (10) VIEWXYZ BY NAME
```

This limit notation overrides any other limit in effect, but applies only to the statement in which it is specified.

**Priority of Limit Settings**

If the limit set with the `LT` parameter is smaller than a limit specified with a `LIMIT` statement or a limit notation, the `LT` limit has priority over any of these other limits.

## Limiting Non-Database Loops - REPEAT Statement

---

Non-database processing loops begin and end based on logical condition criteria or some other specified limiting condition.

The `REPEAT` statement is discussed here as representative of a non-database loop statement.

With the `REPEAT` statement, you specify one or more statements which are to be executed repeatedly. Moreover, you can specify a logical condition, so that the statements are only executed either until or as long as that condition is met. For this purpose you use an `UNTIL` or `WHILE` clause.

If you specify the logical condition

- in an `UNTIL` clause, the `REPEAT` loop will continue *until* the logical condition is met;
- in a `WHILE` clause, the `REPEAT` loop will continue *as long as* the logical condition remains true.

If you specify *no* logical condition, the `REPEAT` loop must be exited with one of the following statements:

- `ESCAPE` terminates the execution of the processing loop and continues processing outside the loop (see [below](#)).
- `STOP` stops the execution of the entire Natural application.
- `TERMINATE` stops the execution of the Natural application and also ends the Natural session.



## Example of REPEAT Statement

```

** Example 'REPEAX01': REPEAT
*****
DEFINE DATA LOCAL
1 MYVIEW VIEW OF EMPLOYEES
  2 NAME
  2 SALARY (1:1)
*
1 #PAY1      (N8)
END-DEFINE
*
READ (5) MYVIEW BY NAME WHERE SALARY (1) = 30000 THRU 39999
  MOVE SALARY (1) TO #PAY1
  /*
  REPEAT WHILE #PAY1 LT 40000
    MULTIPLY #PAY1 BY 1.1
    DISPLAY NAME (IS=ON) SALARY (1)(IS=ON) #PAY1
  END-REPEAT
  /*
  SKIP 1
END-READ
END

```

### Output of Program REPEAX01:

```

Page      1                                04-11-11  14:15:54

```

| NAME       | ANNUAL<br>SALARY | #PAY1 |
|------------|------------------|-------|
| ADKINSON   | 34500            | 37950 |
|            |                  | 41745 |
|            | 33500            | 36850 |
|            |                  | 40535 |
|            | 36000            | 39600 |
|            |                  | 43560 |
| AFANASSIEV | 37000            | 40700 |
| ALEXANDER  | 34500            | 37950 |
|            |                  | 41745 |

## Terminating a Processing Loop - ESCAPE Statement

---

The `ESCAPE` statement is used to terminate the execution of a processing loop based on a logical condition.

You can place an `ESCAPE` statement within loops in conditional `IF` statement groups, in break processing statement groups (`AT END OF DATA`, `AT END OF PAGE`, `AT BREAK`), or as a stand-alone statement implementing the basic logical conditions of a non-database loop.

The `ESCAPE` statement offers the options `TOP` and `BOTTOM`, which determine where processing is to continue after the processing loop has been left via the `ESCAPE` statement:

- `ESCAPE TOP` is used to continue processing at the top of the processing loop.
- `ESCAPE BOTTOM` is used to continue processing with the first statement following the processing loop.

You can specify several `ESCAPE` statements within the same processing loop.

For further details and examples of the `ESCAPE` statement, see the *Statements* documentation.

## Loops Within Loops

---

A database statement can be placed within a database processing loop initiated by another database statement. When database loop-initiating statements are embedded in this way, a “hierarchy” of loops is created, each of which is processed for each record which meets the selection criteria.

Multiple levels of loops can be embedded. For example, non-database loops can be nested one inside the other. Database loops can be nested inside non-database loops. Database and non-database loops can be nested within conditional statement groups.

## Example of Nested FIND Statements

---

The following program illustrates a hierarchy of two loops, with one `FIND` loop nested or embedded within another `FIND` loop.

```

** Example 'FINDX06': FIND (two FIND statements nested)
*****
DEFINE DATA LOCAL
1 EMPLOY-VIEW VIEW OF EMPLOYEES
  2 CITY
  2 NAME
  2 PERSONNEL-ID
1 VEH-VIEW VIEW OF VEHICLES
  2 MAKE
  2 PERSONNEL-ID
END-DEFINE
*
FND1. FIND EMPLOY-VIEW WITH CITY = 'NEW YORK' OR = 'BEVERLEY HILLS'
  FIND (1) VEH-VIEW WITH PERSONNEL-ID = PERSONNEL-ID (FND1.)
  DISPLAY NOTITLE NAME CITY MAKE
  END-FIND
END-FIND
END

```

The above program selects data from multiple files. The outer `FIND` loop selects from the `EMPLOYEES` file all persons who live in New York or Beverley Hills. For each record selected in the outer loop, the inner `FIND` loop is entered, selecting the car data of those persons from the `VEHICLES` file.

Output of Program `FINDX06`:

| NAME    | CITY           | MAKE           |
|---------|----------------|----------------|
| RUBIN   | NEW YORK       | FORD           |
| OLLE    | BEVERLEY HILLS | GENERAL MOTORS |
| WALLACE | NEW YORK       | MAZDA          |
| JONES   | BEVERLEY HILLS | FORD           |
| SPEISER | BEVERLEY HILLS | GENERAL MOTORS |

## Referencing Statements within a Program

Statement reference notation is used for the following purposes:

- Referring to previous statements in a program in order to specify processing over a particular range of data.
- Overriding Natural's [default referencing](#).
- Documenting.

Any Natural statement which causes a processing loop to be initiated and/or causes data elements in a database to be accessed can be referenced, for example:

- READ
- FIND
- HISTOGRAM
- SORT
- REPEAT
- FOR

When multiple processing loops are used in a program, reference notation is used to uniquely identify the particular database field to be processed by referring back to the statement that originally accessed that field in the database.

If a field can be referenced in such a way, this is indicated in the Referencing Permitted column of the *Operand Definition Table* in the corresponding statement description (in the *Statements* documentation). See also [User-Defined Variables](#), [Referencing of Database Fields Using \(r\) Notation](#).

In addition, reference notation can be specified in some statements. For example:

- AT START OF DATA
- AT END OF DATA
- AT BREAK
- ESCAPE BOTTOM

Without reference notation, an AT START OF DATA, AT END OF DATA or AT BREAK statement will be related to the *outermost* active READ, FIND, HISTOGRAM, SORT or READ WORK FILE loop. With reference notation, you can relate it to another active processing loop.

If reference notation is specified with an ESCAPE BOTTOM statement, processing will continue with the first statement following the processing loop identified by the reference notation.

Statement reference notation may be specified in the form of a *statement reference label* or a *source-code line number*.

### ■ **Statement reference label**

A statement reference label consists of several characters, the last of which must be a period (.). The period serves to identify the entry as a label.

A statement that is to be referenced is marked with a label by placing the label at the beginning of the line that contains the statement. For example:

```
0030 ...
0040 READ1. READ VIEWXYZ BY NAME
0050 ...
```

In the statement that references the marked statement, the label is placed in parentheses at the location indicated in the statement's syntax diagram (as described in the *Statements* documentation). For example:

```
AT BREAK (READ1.) OF NAME
```

#### ■ Source-code line number

If source-code line numbers are used for referencing, they must be specified as 4-digit numbers (leading zeros must not be omitted) and in parentheses. For example:

```
AT BREAK (0040) OF NAME
```

In a statement where the label/line number relates a particular field to a previous statement, the label/line number is placed in parentheses after the field name. For example:

```
DISPLAY NAME (READ1.) JOB-TITLE (READ1.) MAKE MODEL
```

Line numbers and labels can be used interchangeably.

See also [User-Defined Variables](#), [Referencing of Database Fields Using \(r\) Notation](#).

## Example of Referencing with Line Numbers

The following program uses source code line numbers (4-digit numbers in parentheses) for referencing.

In this particular example, the line numbers refer to the statements that would be referenced in any case by default.

```
0010 ** Example 'LABELX01': Labels for READ and FIND loops (line numbers)
0020 *****
0030 DEFINE DATA LOCAL
0040 1 MYVIEW1 VIEW OF EMPLOYEES
0050 2 NAME
0060 2 FIRST-NAME
0070 2 PERSONNEL-ID
0080 1 MYVIEW2 VIEW OF VEHICLES
0090 2 PERSONNEL-ID
0100 2 MAKE
0110 END-DEFINE
0120 *
```

```

0130 LIMIT 15
0140 READ MYVIEW1 BY NAME STARTING FROM 'JONES'
0150 FIND MYVIEW2 WITH PERSONNEL-ID = PERSONNEL-ID (0140)
0160     IF NO RECORDS FOUND
0170         MOVE '***NO CAR***' TO MAKE
0180     END-NOREC
0190     DISPLAY NOTITLE NAME          (0140) (IS=ON)
0200                 FIRST-NAME (0140) (IS=ON)
0210                 MAKE          (0150)
0220 END-FIND /* (0150)
0230 END-READ /* (0140)
0240 END

```

## Example with Statement Reference Labels

The following example illustrates the use of statement reference labels.

It is identical to the previous program, except that labels are used for referencing instead of line numbers.

```

** Example 'LABELX02': Labels for READ and FIND loops (user labels)
*****
DEFINE DATA LOCAL
1 MYVIEW1 VIEW OF EMPLOYEES
  2 NAME
  2 FIRST-NAME
  2 PERSONNEL-ID
1 MYVIEW2 VIEW OF VEHICLES
  2 PERSONNEL-ID
  2 MAKE
END-DEFINE
*
LIMIT 15
RD. READ MYVIEW1 BY NAME STARTING FROM 'JONES'
  FD. FIND MYVIEW2 WITH PERSONNEL-ID = PERSONNEL-ID (RD.)
    IF NO RECORDS FOUND
      MOVE '***NO CAR***' TO MAKE
    END-NOREC
    DISPLAY NOTITLE NAME          (RD.) (IS=ON)
                 FIRST-NAME (RD.) (IS=ON)
                 MAKE          (FD.)
  END-FIND /* (FD.)
END-READ /* (RD.)
END ↵

```

Both programs produce the following output:

| NAME      | FIRST-NAME | MAKE           |
|-----------|------------|----------------|
| JONES     | VIRGINIA   | CHRYSLER       |
|           | MARSHA     | CHRYSLER       |
|           |            | CHRYSLER       |
|           | ROBERT     | GENERAL MOTORS |
|           | LILLY      | FORD           |
|           |            | MG             |
|           | EDWARD     | GENERAL MOTORS |
|           | LAUREL     | GENERAL MOTORS |
|           | KEVIN      | DATSUN         |
|           | GREGORY    | FORD           |
| JOPER     | MANFRED    | ***NO CAR***   |
| JOUSSELIN | DANIEL     | RENAULT        |
| JUBE      | GABRIEL    | ***NO CAR***   |
| JUNG      | ERNST      | ***NO CAR***   |
| JUNKIN    | JEREMY     | ***NO CAR***   |
| KAISER    | REINER     | ***NO CAR***   |
| KANT      | HEIKE      | ***NO CAR***   |





# 39 Control Breaks

---

- Use of Control Breaks ..... 372
- AT BREAK Statement ..... 372
- Automatic Break Processing ..... 377
- Example of System Functions with AT BREAK Statement ..... 378
- Further Example of AT BREAK Statement ..... 380
- BEFORE BREAK PROCESSING Statement ..... 380
- Example of BEFORE BREAK PROCESSING Statement ..... 380
- User-Initiated Break Processing - PERFORM BREAK PROCESSING Statement ..... 381
- Example of PERFORM BREAK PROCESSING Statement ..... 383

This chapter describes how the execution of a statement can be made dependent on a control break, and how control breaks can be used for the evaluation of Natural system functions.

## Use of Control Breaks

---

A control break occurs when the value of a control field changes.

The execution of statements can be made dependent on a control break.

A control break can also be used for the evaluation of Natural system functions.

System functions are discussed in [System Variables and System Functions](#). For detailed descriptions of the system functions available, refer to the *System Functions* documentation.

## AT BREAK Statement

---

With the statement `AT BREAK`, you specify the processing which is to be performed whenever a control break occurs, that is, whenever the value of a control field which you specify with the `AT BREAK` statement changes. As a control field, you can use a database field or a user-defined variable.

The following topics are covered below:

- [Control Break Based on a Database Field](#)
- [Control Break Based on a User-Defined Variable](#)
- [Multiple Control Break Levels](#)

### Control Break Based on a Database Field

The field specified as control field in an `AT BREAK` statement is usually a database field.

Example:

```
...  
AT BREAK OF DEPT  
  statements  
END-BREAK  
...
```

In this example, the control field is the database field `DEPT`; if the value of the field changes, for example, `FROM SALE01 to SALE02`, the `statements` specified in the `AT BREAK` statement would be executed.



In the AT END OF DATA statement, the Natural system function TOTAL is evaluated.

Output of Program ATBEX01:

| CITY                  | NAME    | POSITION   | SALARY |
|-----------------------|---------|------------|--------|
| AIKEN                 | SENKO   | PROGRAMMER | 31500  |
| A I K E N             |         | AVERAGE:   | 31500  |
| 1 RECORDS FOUND       |         |            |        |
| ALBUQUERQ             | HAMMOND | SECRETARY  | 22000  |
| ALBUQUERQ             | ROLLING | MANAGER    | 34000  |
| ALBUQUERQ             | FREEMAN | MANAGER    | 34000  |
| ALBUQUERQ             | LINCOLN | ANALYST    | 41000  |
| A L B U Q U E R Q U E |         | AVERAGE:   | 32750  |
| 4 RECORDS FOUND       |         |            |        |
| TOTAL (ALL RECORDS):  |         |            | 162500 |

### Control Break Based on a User-Defined Variable

A **user-defined variable** can also be used as control field in an AT BREAK statement.

In the following program, the user-defined variable #LOCATION is used as control field.

```

** Example 'ATBEX02': AT BREAK OF (with user-defined variable and
**                          in conjunction with BEFORE BREAK PROCESSING)
*****
DEFINE DATA LOCAL
1 MYVIEW VIEW OF EMPLOYEES
  2 CITY
  2 COUNTRY
  2 JOB-TITLE
  2 SALARY (1:1)
*
1 #LOCATION (A20)
END-DEFINE
*
READ (5) MYVIEW BY CITY WHERE COUNTRY = 'USA'
  BEFORE BREAK PROCESSING
    COMPRESS CITY 'USA' INTO #LOCATION
  END-BEFORE
  DISPLAY #LOCATION 'POSITION' JOB-TITLE 'SALARY' SALARY (1)

```

```

/*
  AT BREAK OF #LOCATION
    SKIP 1
  END-BREAK
END-READ
END

```

### Output of Program ATBEX02:

```

Page      1                                04-12-14  14:08:36
-----
#LOCATION          POSITION          SALARY
-----
AIKEN USA        PROGRAMMER          31500
ALBUQUERQUE USA  SECRETARY          22000
ALBUQUERQUE USA  MANAGER            34000
ALBUQUERQUE USA  MANAGER            34000
ALBUQUERQUE USA  ANALYST            41000

```

### Multiple Control Break Levels

As explained [above](#), the notation `/n/` allows some portion of a field to be checked for a control break. It is possible to combine several `AT BREAK` statements, using an entire field as control field for one break and part of the same field as control field for another break.

In such a case, the break at the lower level (entire field) must be specified before the break at the higher level (part of field); that is, in the first `AT BREAK` statement the entire field must be specified as control field, and in the second one part of the field.

The following example program illustrates this, using the field `DEPT` as well as the first 4 positions of that field (`DEPT /4/`).

```

** Example 'ATBEX03': AT BREAK OF (two statements in combination)
*****
DEFINE DATA LOCAL
1 MYVIEW VIEW OF EMPLOYEES
  2 NAME
  2 JOB-TITLE
  2 DEPT
  2 SALARY      (1:1)
  2 CURR-CODE (1:1)
END-DEFINE
*
READ MYVIEW BY DEPT STARTING FROM 'SALE40' ENDING AT 'TECH10'
  WHERE SALARY(1) GT 47000 AND CURR-CODE(1) = 'USD'
/*
  AT BREAK OF DEPT
    WRITE '*** LOWEST BREAK LEVEL ***' /

```

```

END-BREAK
AT BREAK OF DEPT /4/
  WRITE '*** HIGHEST BREAK LEVEL ***'
END-BREAK
/*
  DISPLAY DEPT NAME 'POSITION' JOB-TITLE
END-READ
END

```

## Output of Program ATBEX03:

```

Page      1                                04-12-14  14:09:20
DEPARTMENT      NAME                      POSITION
  CODE
-----
TECH05      HERZOG                      MANAGER
TECH05      LAWLER                      MANAGER
TECH05      MEYER                      MANAGER
*** LOWEST BREAK LEVEL ***

TECH10      DEKKER                      DBA
*** LOWEST BREAK LEVEL ***

*** HIGHEST BREAK LEVEL ***  ←

```

In the following program, one blank line is output whenever the value of the field DEPT changes; and whenever the value in the first 4 positions of DEPT changes, a record count is carried out by evaluating the system function COUNT.

```

** Example 'ATBEX04': AT BREAK OF (two statements in combination)
*****
DEFINE DATA LOCAL
1 MYVIEW VIEW OF EMPLOYEES
  2 DEPT
  2 REDEFINE DEPT
    3 #GENDEP (A4)
  2 NAME
  2 SALARY (1)
END-DEFINE
*
WRITE TITLE '** PERSONS WITH SALARY > 30000, SORTED BY DEPARTMENT **' /
LIMIT 9
READ MYVIEW BY DEPT FROM 'A' WHERE SALARY(1) > 30000
  DISPLAY 'DEPT' DEPT NAME 'SALARY' SALARY(1)
/*
  AT BREAK OF DEPT
    SKIP 1
  END-BREAK
  AT BREAK OF DEPT /4/

```

```

WRITE COUNT(SALARY(1)) 'RECORDS FOUND IN:' OLD(#GENDEP) /
END-BREAK
END-READ
END

```

Output of Program ATBEX04:

```

                ** PERSONS WITH SALARY > 30000, SORTED BY DEPARTMENT **
DEPT          NAME          SALARY
-----
ADMA01 JENSEN              180000
ADMA01 PETERSEN            105000
ADMA01 MORTENSEN          320000
ADMA01 MADSEN             149000
ADMA01 BUHL               642000

ADMA02 HERMANSEN          391500
ADMA02 PLOUG              162900
ADMA02 HANSEN             234000

      8 RECORDS FOUND IN: ADMA

COMP01 HEURTEBISE         168800

      1 RECORDS FOUND IN: COMP

```

## Automatic Break Processing

Automatic break processing is in effect for a processing loop which contains an `AT BREAK` statement. This applies to the following statements:

- FIND
- READ
- HISTOGRAM
- SORT
- READ WORK FILE

The value of the control field specified with the `AT BREAK` statement is checked only for records which satisfy the selection criteria of both the `WITH` clause and the `WHERE` clause.

Natural system functions (`AVER`, `MAX`, `MIN`, etc.) are evaluated for each record after all statements within the processing loop have been executed. System functions are not evaluated for any record which is rejected by `WHERE` criteria.

The figure below illustrates the flow logic of automatic break processing.

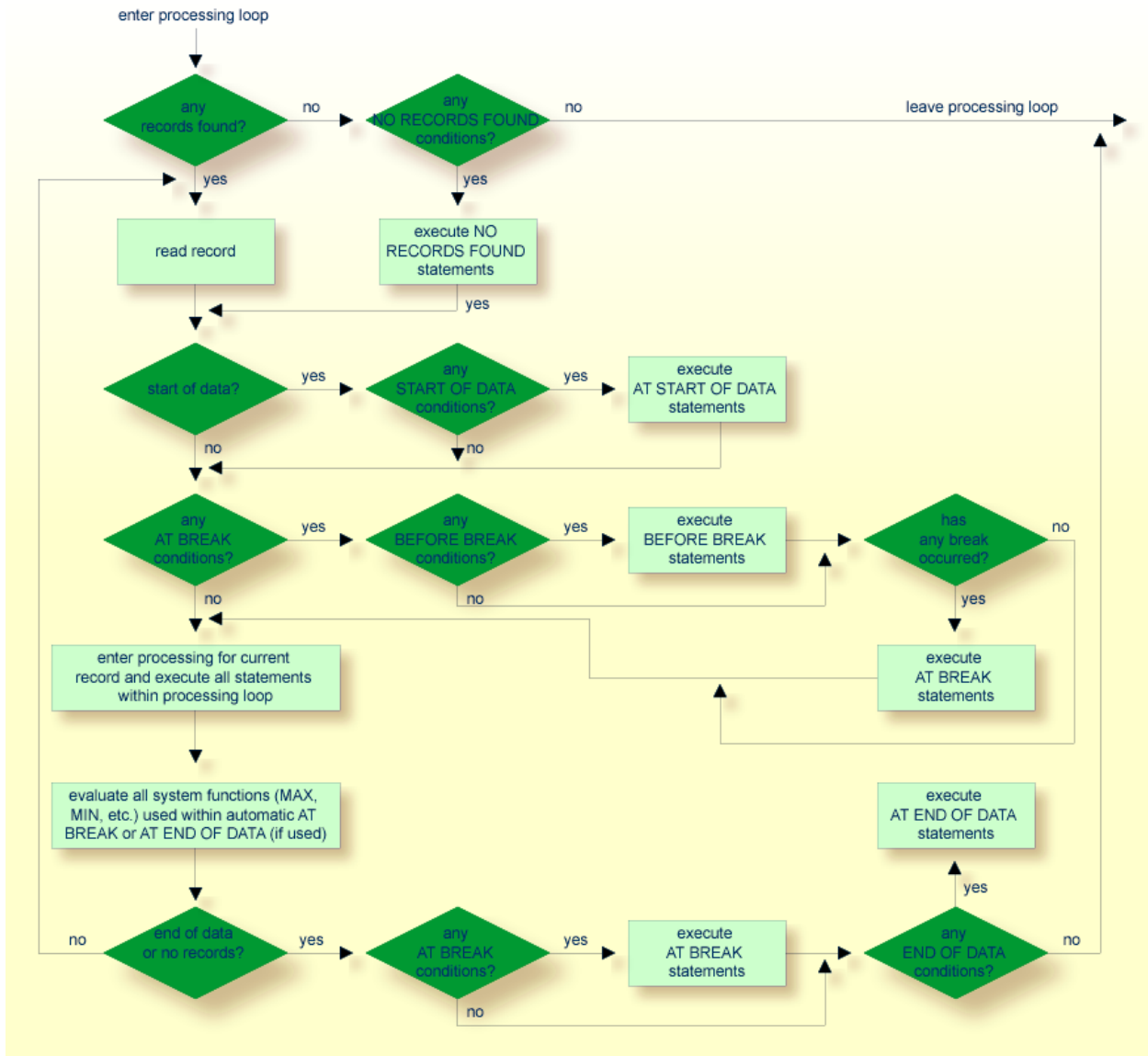

## Example of System Functions with AT BREAK Statement

The following example shows the use of the Natural system functions OLD, MIN, AVER, MAX, SUM and COUNT in an AT BREAK statement (and of the system function TOTAL in an AT END OF DATA statement).



```

** Example 'ATBEX05': AT BREAK OF (with system functions)
*****
DEFINE DATA LOCAL
1 MYVIEW VIEW OF EMPLOYEES
  2 NAME
  2 CITY
  2 SALARY (1:1)
  2 CURR-CODE (1:1)
END-DEFINE
*
LIMIT 3
READ MYVIEW BY CITY = 'SALT LAKE CITY'
  DISPLAY NOTITLE CITY NAME 'SALARY' SALARY(1) 'CURRENCY' CURR-CODE(1)
  /*
  AT BREAK OF CITY
    WRITE / OLD(CITY) (EM=X^X^X^X^X^X^X^X^X^X^X^X^X^X^X^X^X)
      31T ' - MINIMUM:' MIN(SALARY(1)) CURR-CODE(1) /
      31T ' - AVERAGE:' AVER(SALARY(1)) CURR-CODE(1) /
      31T ' - MAXIMUM:' MAX(SALARY(1)) CURR-CODE(1) /
      31T ' - SUM:' SUM(SALARY(1)) CURR-CODE(1) /
      33T COUNT(SALARY(1)) 'RECORDS FOUND' /
  END-BREAK
  /*
  AT END OF DATA
    WRITE 22T 'TOTAL (ALL RECORDS):'
      T*SALARY TOTAL(SALARY(1)) CURR-CODE(1)
  END-ENDDATA
END-READ
END

```

#### Output of Program ATBEX05:

| CITY                    | NAME            | SALARY | CURRENCY |
|-------------------------|-----------------|--------|----------|
| SALT LAKE CITY          | ANDERSON        | 50000  | USD      |
| SALT LAKE CITY          | SAMUELSON       | 24000  | USD      |
| S A L T L A K E C I T Y | - MINIMUM:      | 24000  | USD      |
|                         | - AVERAGE:      | 37000  | USD      |
|                         | - MAXIMUM:      | 50000  | USD      |
|                         | - SUM:          | 74000  | USD      |
|                         | 2 RECORDS FOUND |        |          |
| SAN DIEGO               | GEE             | 60000  | USD      |
| S A N D I E G O         | - MINIMUM:      | 60000  | USD      |
|                         | - AVERAGE:      | 60000  | USD      |
|                         | - MAXIMUM:      | 60000  | USD      |
|                         | - SUM:          | 60000  | USD      |
|                         | 1 RECORDS FOUND |        |          |

TOTAL (ALL RECORDS): 134000 USD ↩

## Further Example of AT BREAK Statement

See the following example program:

- *ATBEX06 - AT BREAK OF (comparing NMIN, NAVER, NCOUNT with MIN, AVER, COUNT)*

## BEFORE BREAK PROCESSING Statement

With the `BEFORE BREAK PROCESSING` statement, you can specify statements that are to be executed immediately before a control break; that is, before the value of the control field is checked, before the statements specified in the `AT BREAK` block are executed, and before any Natural system functions are evaluated.

## Example of BEFORE BREAK PROCESSING Statement

```
** Example 'BEFORX01': BEFORE BREAK PROCESSING
*****
DEFINE DATA LOCAL
1 MYVIEW VIEW OF EMPLOYEES
  2 NAME
  2 FIRST-NAME
  2 SALARY (1:1)
  2 BONUS (1:1,1:1)
*
1 #INCOME (P11)
END-DEFINE
*
LIMIT 5
READ MYVIEW BY NAME FROM 'B'
  BEFORE BREAK PROCESSING
    COMPUTE #INCOME = SALARY(1) + BONUS(1,1)
  END-BEFORE
/*
  DISPLAY NOTITLE NAME FIRST-NAME (AL=10)
    'ANNUAL/INCOME' #INCOME 'SALARY' SALARY(1) (LC==) /
    '+ BONUS' BONUS(1,1) (IC=+)
  AT BREAK OF #INCOME
    WRITE T*#INCOME '-'(24)
  END-BREAK
```

```
END-READ
END
```

### Output of Program BEFORX01:

| NAME     | FIRST-NAME | ANNUAL<br>INCOME | SALARY<br>+ BONUS  |
|----------|------------|------------------|--------------------|
| BACHMANN | HANS       | 56800            | = 52800<br>+4000   |
| BAECKER  | JOHANNES   | 81000            | = 74400<br>+6600   |
| BAECKER  | KARL       | 52650            | = 48600<br>+4050   |
| BAGAZJA  | MARJAN     | 152700           | = 129700<br>+23000 |
| BAILLET  | PATRICK    | 198500           | = 188000<br>+10500 |

## User-Initiated Break Processing - PERFORM BREAK PROCESSING Statement

With automatic break processing, the statements specified in an `AT BREAK` block are executed whenever the value of the specified control field changes - regardless of the position of the `AT BREAK` statement in the processing loop.

With a `PERFORM BREAK PROCESSING` statement, you can perform break processing at a specified position in a processing loop: the `PERFORM BREAK PROCESSING` statement is executed when it is encountered in the processing flow of the program.

Immediately after the `PERFORM BREAK PROCESSING`, you specify one or more `AT BREAK` statement blocks:

```
...
PERFORM BREAK PROCESSING
  AT BREAK OF field1
    statements
  END-BREAK
  AT BREAK OF field2
    statements
  END-BREAK
...
```

When a `PERFORM BREAK PROCESSING` is executed, Natural checks if a break has occurred; that is, if the value of the specified control field has changed; and if it has, the specified statements are executed.

With `PERFORM BREAK PROCESSING`, system functions are evaluated *before* Natural checks if a break has occurred.

The following figure illustrates the flow logic of user-initiated break processing:

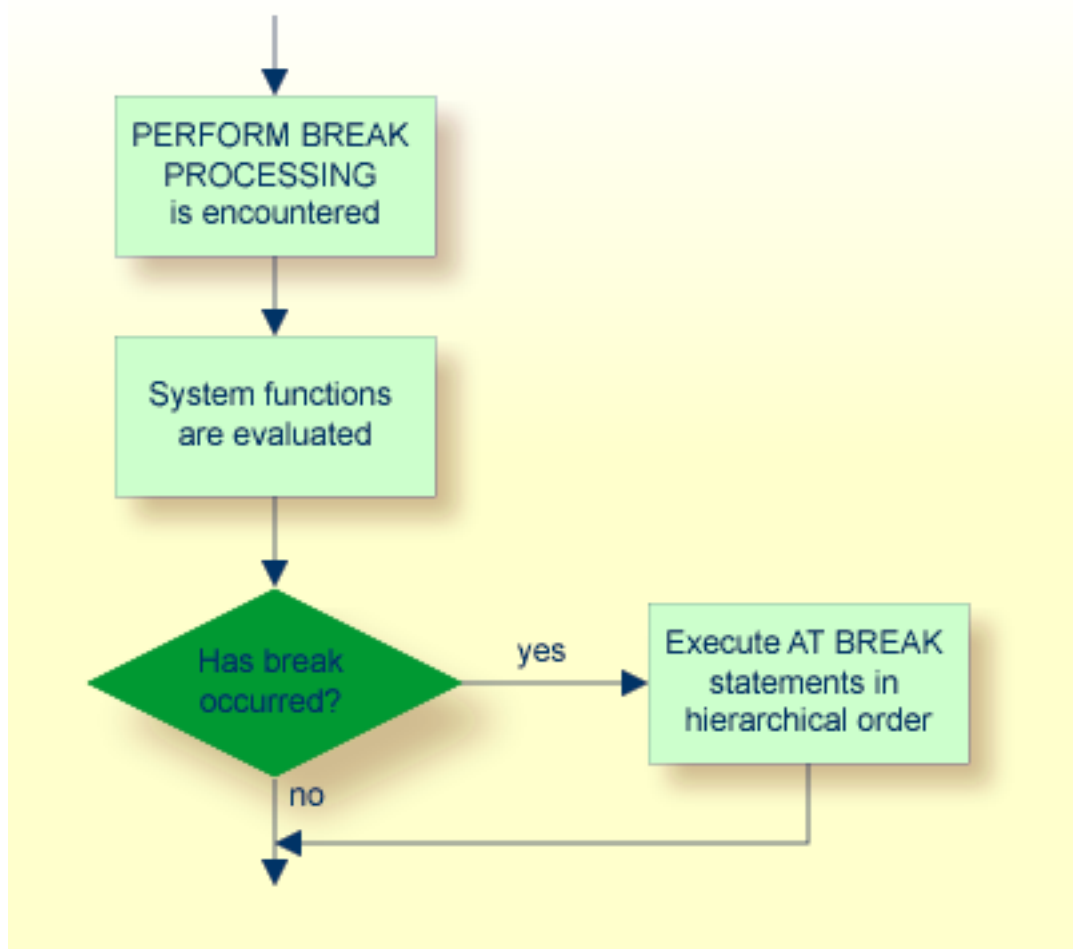

## Example of PERFORM BREAK PROCESSING Statement

```

** Example 'PERFBX01': PERFORM BREAK PROCESSING (with BREAK option
**                               in IF statement)
*****
DEFINE DATA LOCAL
1 MYVIEW VIEW OF EMPLOYEES
  2 NAME
  2 DEPT
  2 SALARY (1:1)
*
1 #CNTL      (N2)
END-DEFINE
*
LIMIT 7
READ MYVIEW BY DEPT
  AT BREAK OF DEPT                /* <- automatic break processing
  SKIP 1
  WRITE 'SUMMARY FOR ALL SALARIES      '
        'SUM:'  SUM(SALARY(1))
        'TOTAL:' TOTAL(SALARY(1))
  ADD 1 TO #CNTL
END-BREAK
/*
IF SALARY (1) GREATER THAN 100000 OR BREAK #CNTL
  PERFORM BREAK PROCESSING        /* <- user-initiated break processing
  AT BREAK OF #CNTL
    WRITE 'SUMMARY FOR SALARY GREATER 100000'
          'SUM:'  SUM(SALARY(1))
          'TOTAL:' TOTAL(SALARY(1))
  END-BREAK
END-IF
/*
IF SALARY (1) GREATER THAN 150000 OR BREAK #CNTL
  PERFORM BREAK PROCESSING        /* <- user-initiated break processing
  AT BREAK OF #CNTL
    WRITE 'SUMMARY FOR SALARY GREATER 150000'
          'SUM:'  SUM(SALARY(1))
          'TOTAL:' TOTAL(SALARY(1))
  END-BREAK
END-IF
DISPLAY NAME DEPT SALARY(1)
END-READ
END

```

Output of Program PERFBX01:

## Control Breaks

---

Page 1 04-12-14 14:13:35

| NAME                              | DEPARTMENT<br>CODE | ANNUAL<br>SALARY |         |        |         |
|-----------------------------------|--------------------|------------------|---------|--------|---------|
| JENSEN                            | ADMA01             | 180000           |         |        |         |
| PETERSEN                          | ADMA01             | 105000           |         |        |         |
| MORTENSEN                         | ADMA01             | 320000           |         |        |         |
| MADSEN                            | ADMA01             | 149000           |         |        |         |
| BUHL                              | ADMA01             | 642000           |         |        |         |
| SUMMARY FOR ALL SALARIES          |                    | SUM:             | 1396000 | TOTAL: | 1396000 |
| SUMMARY FOR SALARY GREATER 100000 |                    | SUM:             | 1396000 | TOTAL: | 1396000 |
| SUMMARY FOR SALARY GREATER 150000 |                    | SUM:             | 1142000 | TOTAL: | 1142000 |
| HERMANSEN                         | ADMA02             | 391500           |         |        |         |
| PLOUG                             | ADMA02             | 162900           |         |        |         |
| SUMMARY FOR ALL SALARIES          |                    | SUM:             | 554400  | TOTAL: | 1950400 |
| SUMMARY FOR SALARY GREATER 100000 |                    | SUM:             | 554400  | TOTAL: | 1950400 |
| SUMMARY FOR SALARY GREATER 150000 |                    | SUM:             | 554400  | TOTAL: | 1696400 |

←

# 40

## Data Computation

---

|                                                                   |     |
|-------------------------------------------------------------------|-----|
| ▪ COMPUTE Statement .....                                         | 386 |
| ▪ Statements MOVE and COMPUTE .....                               | 387 |
| ▪ Statements ADD, SUBTRACT, MULTIPLY and DIVIDE .....             | 388 |
| ▪ Example of MOVE, SUBTRACT and COMPUTE Statements .....          | 388 |
| ▪ COMPRESS Statement .....                                        | 389 |
| ▪ Example of COMPRESS and MOVE Statements .....                   | 390 |
| ▪ Example of COMPRESS Statement .....                             | 391 |
| ▪ Mathematical Functions .....                                    | 392 |
| ▪ Further Examples of COMPUTE, MOVE and COMPRESS Statements ..... | 393 |

This chapter discusses arithmetic statements that are used for computing data:

- COMPUTE
- ADD
- SUBTRACT
- MULTIPLY
- DIVIDE

In addition, the following statements are discussed which are used to transfer the value of an operand into one or more fields:

- MOVE
- COMPRESS

 **Important:** For optimum processing, **user-defined variables** used in arithmetic statements should be defined with format P (packed numeric).

## COMPUTE Statement

---

The COMPUTE statement is used to perform arithmetic operations. The following connecting operators are available:

|     |                                                       |
|-----|-------------------------------------------------------|
| **  | Exponentiation                                        |
| *   | Multiplication                                        |
| /   | Division                                              |
| +   | Addition                                              |
| -   | Subtraction                                           |
| ( ) | Parentheses may be used to indicate logical grouping. |



**Example 1:**

```
COMPUTE LEAVE-DUE = LEAVE-DUE * 1.1
```

In this example, the value of the field `LEAVE-DUE` is multiplied by 1.1, and the result is placed in the field `LEAVE-DUE`.

**Example 2:**

```
COMPUTE #A = SQRT (#B)
```

In this example, the square root of the value of the field `#B` is evaluated, and the result is assigned to the field `#A`.

`SQRT` is a mathematical function supported in the following arithmetic statements:

- `COMPUTE`
- `ADD`
- `SUBTRACT`
- `MULTIPLY`
- `DIVIDE`

For an overview of mathematical functions, see [Mathematical Functions](#) below.

**Example 3:**

```
COMPUTE #INCOME = BONUS (1,1) + SALARY (1)
```

In this example, the first bonus of the current year and the current salary amount are added and assigned to the field `#INCOME`.

## Statements `MOVE` and `COMPUTE`

The statements `MOVE` and `COMPUTE` can be used to transfer the value of an operand into one or more fields. The operand may be a constant such as a text item or a number, a database field, a user-defined variable, a system variable, or, in certain cases, a system function.

The difference between the two statements is that in the `MOVE` statement the value to be moved is specified on the left; in the `COMPUTE` statement the value to be assigned is specified on the right, as shown in the following examples.

**Examples:**

```
MOVE NAME TO #LAST-NAME
COMPUTE #LAST-NAME = NAME
```

---

**Statements ADD, SUBTRACT, MULTIPLY and DIVIDE**

---

The ADD, SUBTRACT, MULTIPLY and DIVIDE statements are used to perform arithmetic operations.

**Examples:**

```
ADD +5 -2 -1 GIVING #A
SUBTRACT 6 FROM 11 GIVING #B
MULTIPLY 3 BY 4 GIVING #C
DIVIDE 3 INTO #D GIVING #E
```

All four statements have a `ROUNDED` option, which you can use if you wish the result of the operation to be rounded.

For rules on rounding, see [Rules for Arithmetic Assignment](#).

The *Statements* documentation provides more detailed information on these statements.

---

**Example of MOVE, SUBTRACT and COMPUTE Statements**

---

The following program demonstrates the use of **user-defined variables** in arithmetic statements. It calculates the ages and wages of three employees and outputs these.

```
** Example 'COMPUX01': COMPUTE
*****
DEFINE DATA LOCAL
1 MYVIEW VIEW OF EMPLOYEES
  2 NAME
  2 BIRTH
  2 JOB-TITLE
  2 SALARY          (1:1)
  2 BONUS           (1:1,1:1)
*
1 #DATE             (N8)
1 REDEFINE #DATE
  2 #YEAR           (N4)
  2 #MONTH          (N2)
  2 #DAY            (N2)
1 #BIRTH-YEAR      (A4)
1 REDEFINE #BIRTH-YEAR
```

```

2 #BIRTH-YEAR-N (N4)
1 #AGE (N3)
1 #INCOME (P9)
END-DEFINE
*
MOVE *DATN TO #DATE
*
READ (3) MYVIEW BY NAME STARTING FROM 'JONES'
  MOVE EDITED BIRTH (EM=YYYY) TO #BIRTH-YEAR
  SUBTRACT #BIRTH-YEAR-N FROM #YEAR GIVING #AGE
  /*
  COMPUTE #INCOME = BONUS (1:1,1:1) + SALARY (1:1)
  /*
  DISPLAY NAME 'POSITION' JOB-TITLE #AGE #INCOME
END-READ
END

```

### Output of Program COMPUX01:

```

Page      1                                04-11-11  14:15:54
      NAME                POSITION          #AGE  #INCOME
-----
JONES          MANAGER                63    55000
JONES          DIRECTOR                58    50000
JONES          PROGRAMMER               48    31000

```

## COMPRESS Statement

The `COMPRESS` statement is used to transfer (combine) the contents of two or more operands into a single alphanumeric field.

Leading zeros in a numeric field and trailing blanks in an alphanumeric field are suppressed before the field value is moved to the receiving field.

By default, the transferred values are separated from one another by a single blank in the receiving field. For other separating possibilities, see the `COMPRESS` statement option `LEAVING NO SPACE` (in the *Statements* documentation).

**Example:**

```
COMPRESS 'NAME:' FIRST-NAME #LAST-NAME INTO #FULLNAME
```

In this example, a COMPRESS statement is used to combine a text constant ('NAME: '), a database field (FIRST-NAME) and a user-defined variable (#LAST-NAME) into one user-defined variable (#FULLNAME).

For further information on the COMPRESS statement, please refer to the COMPRESS statement description (in the *Statements* documentation).

## Example of COMPRESS and MOVE Statements

---

The following program illustrates the use of the statements MOVE and COMPRESS.

```
** Example 'COMPRX01': COMPRESS
*****
DEFINE DATA LOCAL
1 MYVIEW VIEW OF EMPLOYEES
  2 NAME
  2 FIRST-NAME
  2 MIDDLE-I
*
1 #LAST-NAME (A15)
1 #FULL-NAME (A30)
END-DEFINE
*
READ (3) MYVIEW BY NAME STARTING FROM 'JONES'
  MOVE NAME TO #LAST-NAME
  /*
  COMPRESS 'NAME:' FIRST-NAME MIDDLE-I #LAST-NAME INTO #FULL-NAME
  /*
  DISPLAY #FULL-NAME (UC==) FIRST-NAME 'I' MIDDLE-I (AL=1) NAME
END-READ
END
```

Output of Program COMPRX01:

Notice the output format of the compressed field.

|       |                        |            |          |          |
|-------|------------------------|------------|----------|----------|
| Page  | 1                      |            | 04-11-11 | 14:15:54 |
|       | #FULL-NAME             | FIRST-NAME | I        | NAME     |
| ===== |                        |            |          |          |
|       | NAME: VIRGINIA J JONES | VIRGINIA   | J JONES  |          |
|       | NAME: MARSHA JONES     | MARSHA     | JONES    |          |
|       | NAME: ROBERT B JONES   | ROBERT     | B JONES  |          |

In multiple-line displays, it may be useful to combine fields/text in a **user-defined variables** by using a COMPRESS statement.

## Example of COMPRESS Statement

In the following program, three **user-defined variables** are used: #FULL-SALARY, #FULL-NAME, and #FULL-CITY. #FULL-SALARY, for example, contains the text 'SALARY: ' and the database fields SALARY and CURR-CODE. The WRITE statement then references only the compressed variables.

```

** Example 'COMPRX02': COMPRESS
*****
DEFINE DATA LOCAL
1 VIEWEMP VIEW OF EMPLOYEES
  2 NAME
  2 FIRST-NAME
  2 SALARY      (1:1)
  2 CURR-CODE  (1:1)
  2 CITY
  2 ADDRESS-LINE (1:1)
  2 ZIP
*
1 #FULL-SALARY  (A25)
1 #FULL-NAME    (A25)
1 #FULL-CITY    (A25)
END-DEFINE
*
READ (3) VIEWEMP BY CITY STARTING FROM 'NEW YORK'
  COMPRESS 'SALARY:' CURR-CODE(1) SALARY(1) INTO #FULL-SALARY
  COMPRESS FIRST-NAME NAME INTO #FULL-NAME
  COMPRESS ZIP CITY INTO #FULL-CITY
/*
  DISPLAY 'NAME AND ADDRESS' NAME (EM=X^X^X^X^X^X^X^X^X^X^X^X^X)
  WRITE 1/5 #FULL-NAME
        1/37 #FULL-SALARY
        2/5 ADDRESS-LINE (1)
        3/5 #FULL-CITY
  SKIP 1
END-READ
END

```

## Output of Program COMPRX02:

```

Page          1                                04-11-11  14:15:54
-----
NAME AND ADDRESS
-----
R U B I N
  SYLVIA RUBIN                SALARY: USD 17000
  2003 SARAZEN PLACE
  10036 NEW YORK

W A L L A C E
  MARY WALLACE                SALARY: USD 38000
  12248 LAUREL GLADE C
  10036 NEW YORK

K E L L O G G
  HENRIETTA KELLOGG          SALARY: USD 52000
  1001 JEFF RYAN DR.
  19711 NEWARK

```

## Mathematical Functions

The following Natural mathematical functions are supported in arithmetic processing statements (ADD, COMPUTE, DIVIDE, SUBTRACT, MULTIPLY).

| Mathematical Function                           | Natural System Function |
|-------------------------------------------------|-------------------------|
| Absolute value of <i>field</i> .                | ABS( <i>field</i> )     |
| Arc tangent of <i>field</i> .                   | ATN( <i>field</i> )     |
| Cosine of <i>field</i> .                        | COS( <i>field</i> )     |
| Exponential of <i>field</i> .                   | EXP( <i>field</i> )     |
| Fractional part of <i>field</i> .               | FRAC( <i>field</i> )    |
| Integer part of <i>field</i> .                  | INT( <i>field</i> )     |
| Natural logarithm of <i>field</i> .             | LOG( <i>field</i> )     |
| Sign of <i>field</i> .                          | SGN( <i>field</i> )     |
| Sine of <i>field</i> .                          | SIN( <i>field</i> )     |
| Square root of <i>field</i> .                   | SQRT( <i>field</i> )    |
| Tangent of <i>field</i> .                       | TAN( <i>field</i> )     |
| Numeric value of an alphanumeric <i>field</i> . | VAL( <i>field</i> )     |

See also the *System Functions* documentation for a detailed explanation of each mathematical function.

## Further Examples of COMPUTE, MOVE and COMPRESS Statements

---

See the following example programs:

- *WRITEX11 - WRITE (with nX, n/n and COMPRESS)*
- *IFX03 - IF statement*
- *COMPRX03 - COMPRESS (using parameters LC and TC)*





# 41 System Variables and System Functions

---

|                                                          |     |
|----------------------------------------------------------|-----|
| ▪ System Variables .....                                 | 396 |
| ▪ System Functions .....                                 | 397 |
| ▪ Example of System Variables and System Functions ..... | 398 |
| ▪ Further Examples of System Variables .....             | 399 |
| ▪ Further Examples of System Functions .....             | 400 |

This chapter describes the purpose of Natural system variables and Natural system functions and how they are used in Natural programs.

## System Variables

---

The following topics are covered below:

- [Purpose](#)
- [Characteristics of System Variables](#)
- [System Variables Grouped by Function](#)

### Purpose

System variables are used to display system information. They may be referenced at any point within a Natural program.

Natural system variables provide variable information, for example, about the current Natural session:

- the current library;
- the user and terminal identification;
- the current status of a loop processing;
- the current report processing status;
- the current date and time.

The typical use of system variables is illustrated in the [Example of System Variables and System Functions](#) below and in the examples contained in library SYSEXPG.

The information contained in a system variable may be used in Natural programs by specifying the appropriate system variables. For example, date and time system variables may be specified in a DISPLAY, WRITE, PRINT, MOVE or COMPUTE statement.

### Characteristics of System Variables

The names of all system variables begin with an asterisk (\*).

### Format/Length

Information on format and length is given in the detailed descriptions in the *System Variables* documentation. The following abbreviations are used:

| Format |                    |
|--------|--------------------|
| A      | Alphanumeric       |
| B      | Binary             |
| D      | Date               |
| I      | Integer            |
| L      | Logical            |
| N      | Numeric (unpacked) |
| P      | Packed numeric     |
| T      | Time               |

### Content Modifiable

In the individual descriptions, this indicates whether in a Natural program you can assign another value to the system variable, that is, overwrite its content as generated by Natural.

### System Variables Grouped by Function

The Natural system variables are grouped as follows:

- Application Related System Variables
- Date and Time System Variables
- Input/Output Related System Variables
- Natural Environment Related System Variables
- System Environment Related System Variables
- XML Related System Variables

For detailed descriptions of all system variables, see the *System Variables* documentation.

## System Functions

Natural system functions comprise a set of statistical and mathematical functions that can be applied to the data after a record has been processed, but before break processing occurs.

System functions may be specified in a `DISPLAY`, `WRITE`, `PRINT`, `MOVE` or `COMPUTE` statement that is used in conjunction with an `AT END OF PAGE`, `AT END OF DATA` or `AT BREAK` statement.

In the case of an `AT END OF PAGE` statement, the corresponding `DISPLAY` statement must include the `GIVE SYSTEM FUNCTIONS` clause (as shown in the example [below](#)).

The following functional groups of system functions exist:

- System Functions for Use in Processing Loops
- Mathematical Functions
- Miscellaneous Functions

For detailed information on all system functions available, see the *System Functions* documentation.

See also *Using System Functions in Processing Loops* (in the *System Functions* documentation).

The typical use of system functions is explained in the example programs given below and in the examples contained in library [SYSEXPG](#).

## Example of System Variables and System Functions

---

The following example program illustrates the use of system variables and system functions:

```
** Example 'SYSVAX01': System variables and system functions
*****
DEFINE DATA LOCAL
1 MYVIEW VIEW OF EMPLOYEES
  2 CITY
  2 NAME
  2 JOB-TITLE
  2 INCOME (1:1)
    3 CURR-CODE
    3 SALARY
    3 BONUS (1:1)
END-DEFINE
*
WRITE TITLE LEFT JUSTIFIED 'EMPLOYEE SALARY REPORT AS OF' *DAT4E /
*
READ (3) MYVIEW BY CITY STARTING FROM 'E'
  DISPLAY GIVE SYSTEM FUNCTIONS
    NAME (AL=15) JOB-TITLE (AL=15) INCOME (1:1)
  AT START OF DATA
    WRITE 'REPORT CREATED AT:' *TIME 'HOURS' /
  END-START
  AT END OF DATA
    WRITE / 'LAST PERSON SELECTED:' OLD (NAME) /
  END-ENDDATA
END-READ
*
AT END OF PAGE
  WRITE 'AVERAGE SALARY:' AVER (SALARY(1))
END-ENDPAGE
END
```

Explanation:

- The system variable `*DATE` is output with the `WRITE TITLE` statement.
- The system variable `*TIME` is output with the `AT START OF DATA` statement.
- The system function `OLD` is used in the `AT END OF DATA` statement.
- The system function `AVER` is used in the `AT END OF PAGE` statement.

Output of Program `SYSVAX01`:

Note how the system variables and system function are displayed.

```
EMPLOYEE SALARY REPORT AS OF 11/11/2004

      NAME                CURRENT POSITION                INCOME
                                CURRENCY ANNUAL BONUS
                                CODE     SALARY
-----
REPORT CREATED AT: 14:15:55.0 HOURS

DUYVERMAN    PROGRAMMER        USD        34000        0
PRATT        SALES PERSON     USD        38000        9000
MARKUSH      TRAINEE          USD        22000        0

LAST PERSON SELECTED: MARKUSH

AVERAGE SALARY:          31333
```

## Further Examples of System Variables

See the following example programs:

- *EDITMX05 - Edit mask (EM for date and time system variables)*
- *READX04 - READ (in combination with FIND and the system variables \*NUMBER and \*COUNTER)*
- *WTITLX01 - WRITE TITLE (with \*PAGE-NUMBER)*

## Further Examples of System Functions

---

See the following example programs:

- *ATBREX06 - AT BREAK OF (comparing NMIN, NAVER, NCOUNT with MIN, AVER, COUNT)*
- *ATENPX01 - AT END OF PAGE (with system function available via GIVE SYSTEMFUNCTIONS in DISPLAY)*

# 42 Stack

---

|                                   |     |
|-----------------------------------|-----|
| ▪ Use of Natural Stack .....      | 402 |
| ▪ Stack Processing .....          | 402 |
| ▪ Placing Data on the Stack ..... | 403 |
| ▪ Clearing the Stack .....        | 404 |

The Natural stack is a kind of “intermediate storage” in which you can store Natural commands, user-defined commands, and input data to be used by an `INPUT` statement.

## Use of Natural Stack

---

In the stack you can store a series of functions which are frequently executed one after the other, such as a series of logon commands.

The data/commands stored in the stack are “stacked” on top of one another. You can decide whether to put them on top or at the bottom of the stack. The data/command in the stack can only be processed in the order in which they are stacked, beginning from the top of the stack.

In a program, you may reference the system variable `*DATA` to determine the content of the stack (see the *System Variables* documentation for further information).

## Stack Processing

---

The processing of the commands/data stored in the stack differs depending on the function being performed.

If a command is expected, that is, the `NEXT` prompt is about to be displayed, Natural first checks if a command is on the top of the stack. If there is, the `NEXT` prompt is suppressed and the command is read and deleted from the stack; the command is then executed as if it had been entered manually in response to the `NEXT` prompt.

If an `INPUT` statement containing input fields is being executed, Natural first checks if there are any input data on the top of the stack. If there are, these data are passed to the `INPUT` statement (in delimiter mode); the data read from the stack must be format-compatible with the variables in the `INPUT` statement; the data are then deleted from the stack. See also *Processing Data from the Natural Stack* in the `INPUT` statement description.

If an `INPUT` statement was executed using data from the stack, and this `INPUT` statement is re-executed via a `REINPUT` statement, the `INPUT` statement screen will be re-executed displaying the same data from the stack as when it was executed originally. With the `REINPUT` statement, no further data are read from the stack.

When a Natural program terminates normally, the stack is flushed beginning from the top until either a command is on the top of the stack or the stack is cleared. When a Natural program is terminated via the terminal command `%%` or with an error, the stack is cleared entirely.



---

## Placing Data on the Stack

---

The following methods can be used to place data/commands on the stack:

- [STACK Parameter](#)
- [STACK Statement](#)
- [FETCH and RUN Statements](#)

### STACK Parameter

The Natural profile parameter `STACK` may be used to place data/commands on the stack. The `STACK` parameter (described in the *Parameter Reference*) can be specified by the Natural administrator in the Natural parameter module at the installation of Natural; or you can specify it as a dynamic parameter when you invoke Natural.

When data/commands are to be placed on the stack via the `STACK` parameter, multiple commands must be separated from one another by a semicolon (;). If a command is to be passed within a sequence of data or command elements, it must be preceded by a semicolon.

Data for multiple `INPUT` statements must be separated from one another by a colon (:). Data that are to be read by a separate `INPUT` statement must be preceded by a colon. If a command is to be stacked which requires parameters, no colon is to be placed between the command and the parameters.

Semicolon and colon must not be used within the input data themselves as they will be interpreted as separation characters.

### STACK Statement

The `STACK` statement can be used within a program to place data/commands in the stack. The data elements specified in one `STACK` statement will be used for one `INPUT` statement, which means that if data for multiple `INPUT` statements are to be placed on the stack, multiple `STACK` statements must be used.

Data may be placed on the stack either unformatted or formatted:

- If unformatted data are read from the stack, the data string is interpreted in delimiter mode and the characters specified with the session parameters `IA` (Input Assignment character) and `ID` (Input Delimiter character) are processed as control characters for **keyword** assignment and data separation.
- If formatted data are placed on the stack, each content of a field will be separated and passed to one input field in the corresponding `INPUT` statement. If the data to be placed on the stack contains delimiter, control or DBCS characters, it should be placed formatted on the stack to avoid unintentional interpretation of these characters.

See the *Statements* documentation for further information on the `STACK` statement.

### FETCH and RUN Statements

The execution of a `FETCH` or `RUN` statement that contains parameters to be passed to the invoked program will result in these parameters being placed on top of the stack.

## Clearing the Stack

---

The contents of the stack can be deleted with the `RELEASE` statement. See the *Statements* documentation for details on the `RELEASE` statement.



**Note:** When a Natural program is terminated via the terminal command `%%` or with an error, the stack is cleared entirely.

# 43 Processing of Date Information

---

- Edit Masks for Date Fields and Date System Variables ..... 406
- Default Edit Mask for Date - DTFORM Parameter ..... 406
- Date Format for Alphanumeric Representation - DF Parameter ..... 407
- Date Format for Output - DFOUT Parameter ..... 409
- Date Format for Stack - DFSTACK Parameter ..... 410
- Year Sliding Window - YSLW Parameter ..... 411
- Combinations of DFSTACK and YSLW ..... 413
- Year Fixed Window ..... 415
- Date Format for Default Page Title - DFTITLE Parameter ..... 415

This chapter covers various aspects concerning the handling of date information in Natural applications.

## Edit Masks for Date Fields and Date System Variables

---

If you wish the value of a date field to be output in a specific representation, you usually specify an **edit mask** for the field. With an edit mask, you determine character by character what the output is to look like.

If you wish to use the current date in a specific representation, you need not define a date field and specify an edit mask for it; instead you can simply use a *date system variable*. Natural provides various date system variables, which contain the current date in different representations. Some of these representations contain a 2-digit year component, some a 4-digit year component.

For more information and a list of all date system variables, see the *System Variables* documentation.

## Default Edit Mask for Date - DTFORM Parameter

---

The profile parameter `DTFORM` determines the default format used for dates as part of the default title on Natural reports, for date constants and for date input.

This date format determines the sequence of the day, month and year components of a date, as well as the delimiter characters to be used between these components.

Possible `DTFORM` settings are:

| Setting               | Date Format             | Example    |
|-----------------------|-------------------------|------------|
| <code>DTFORM=I</code> | <code>yyyy-mm-dd</code> | 2005-12-31 |
| <code>DTFORM=G</code> | <code>dd.mm.yyyy</code> | 31.12.2005 |
| <code>DTFORM=E</code> | <code>dd/mm/yyyy</code> | 31/12/2005 |
| <code>DTFORM=U</code> | <code>mm/dd/yyyy</code> | 12/31/2005 |

\* `dd` = day, `mm` = month, `yyyy` = year.

The `DTFORM` parameter can be set in the Natural parameter module/file or dynamically when Natural is invoked. By default, `DTFORM=I` applies.

## Date Format for Alphanumeric Representation - DF Parameter

If an edit mask is specified, the representation of the field value is determined by the edit mask. If no edit mask is specified, the representation of the field value is determined by the session parameter `DF` in combination with the profile parameter `DTFORM`.

With the `DF` parameter, you can choose one of the following date representations:

|                   |                                                                                           |
|-------------------|-------------------------------------------------------------------------------------------|
| <code>DF=S</code> | 8-byte representation with 2-digit year component and delimiters ( <i>yy-mm-dd</i> ).     |
| <code>DF=I</code> | 8-byte representation with 4-digit year component without delimiters ( <i>yyyymmdd</i> ). |
| <code>DF=L</code> | 10-byte representation with 4-digit year component and delimiters ( <i>yyyy-mm-dd</i> ).  |

For each representation, the sequence of the day, month and year components, and the delimiter characters used, are determined by the `DTFORM` parameter.

By default, `DF=S` applies (except for `INPUT` statements; see below).

The session parameter `DF` is evaluated at compilation.

It can be specified with the following statements:

- `FORMAT`,
- `INPUT`, `DISPLAY`, `WRITE` and `PRINT` at statement and element (field) level,
- `MOVE`, `COMPRESS`, `STACK`, `RUN` and `FETCH` at element (field) level.

When specified in one of these statements, the `DF` parameter applies to the following:

| Statement                                                         | Effect of DF parameter                                                                                                                                                                                                                                                                                                                                                                                |
|-------------------------------------------------------------------|-------------------------------------------------------------------------------------------------------------------------------------------------------------------------------------------------------------------------------------------------------------------------------------------------------------------------------------------------------------------------------------------------------|
| <code>DISPLAY</code> , <code>WRITE</code> ,<br><code>PRINT</code> | When the value of a date variable is output with one of these statements, the value is converted to an alphanumeric representation before it is output. The <code>DF</code> parameter determines which representation is used.                                                                                                                                                                        |
| <code>MOVE</code> , <code>COMPRESS</code>                         | When the value of a date variable is transferred to an alphanumeric field with a <code>MOVE</code> or <code>COMPRESS</code> statement, the value is converted to an alphanumeric representation before it is transferred. The <code>DF</code> parameter determines which representation is used.                                                                                                      |
| <code>STACK</code> , <code>RUN</code> , <code>FETCH</code>        | When the value of a date variable is placed on the stack, it is converted to alphanumeric representation before it is placed on the stack. The <code>DF</code> parameter determines which representation is used.<br><br>The same applies when a date variable is specified as a parameter in a <code>FETCH</code> or <code>RUN</code> statement (as these parameters are also passed via the stack). |

| Statement | Effect of DF parameter                                                                                                                                                                                                                                                                                                                                                                                                                                                                                                                     |
|-----------|--------------------------------------------------------------------------------------------------------------------------------------------------------------------------------------------------------------------------------------------------------------------------------------------------------------------------------------------------------------------------------------------------------------------------------------------------------------------------------------------------------------------------------------------|
| INPUT     | <p>When a data variable is used in an INPUT statement, the DF parameter determines how a value must be entered in the field.</p> <p>However, when a date variable for which <i>no</i> DF parameter is specified is used in an INPUT statement, the date can be entered either with a 2-digit year component and delimiters or with a 4-digit year component and no delimiters. In this case, too, the sequence of the day, month and year components, and the delimiter characters to be used, are determined by the DTFORM parameter.</p> |

 **Note:** With DF=S, only 2 digits are provided for the year information; this means that if a date value contained the century, this information would be lost during the conversion. To retain the century information, you set DF=I or DF=L.

### Examples of DF Parameter with WRITE Statements

These examples assume that DTFORM=G applies.

```
/* DF=S (default)
WRITE *DATX /* Output has this format: dd.mm.yy
END
```

```
FORMAT DF=I
WRITE *DATX /* Output has this format: ddmmyyy
END
```

```
FORMAT DF=L
WRITE *DATX /* Output has this format: dd.mm.yyyy
END
```

### Example of DF Parameter with MOVE Statement

This example assumes that DTFORM=E applies.

```
DEFINE DATA LOCAL
  1 #DATE (D) INIT <D'31/12/2005'>
  1 #ALPHA (A10)
END-DEFINE
...
MOVE #DATE TO #ALPHA /* Result: #ALPHA contains 31/12/05
MOVE #DATE (DF=I) TO #ALPHA /* Result: #ALPHA contains 31122005
MOVE #DATE (DF=L) TO #ALPHA /* Result: #ALPHA contains 31/12/2005
...
```

## Example of DF Parameter with STACK Statement

This example assumes that `DTFORM=I` applies.

```

DEFINE DATA LOCAL
  1 #DATE (D) INIT <D'2005-12-31'>
  1 #ALPHA1(A10)
  1 #ALPHA2(A10)
  1 #ALPHA3(A10)
END-DEFINE
...
STACK TOP DATA #DATE (DF=S) #DATE (DF=I) #DATE (DF=L)
...
INPUT #ALPHA1 #ALPHA2 #ALPHA3
...
/* Result: #ALPHA1 contains 05-12-31
/*          #ALPHA2 contains 20051231
/*          #ALPHA3 contains 2005-12-31
...

```

## Example of DF Parameter with INPUT Statement

This example assumes that `DTFORM=I` applies.

```

DEFINE DATA LOCAL
  1 #DATE1 (D)
  1 #DATE2 (D)
  1 #DATE3 (D)
  1 #DATE4 (D)
END-DEFINE
...
INPUT #DATE1 (DF=S) /* Input must have this format: yy-mm-dd
      #DATE2 (DF=I) /* Input must have this format: yyyymmdd
      #DATE3 (DF=L) /* Input must have this format: yyyy-mm-dd
      #DATE4          /* Input must have this format: yy-mm-dd or yyyymmdd
...

```

## Date Format for Output - DFOUT Parameter

The session/profile parameter `DFOUT` only applies to date fields in `INPUT`, `DISPLAY`, `WRITE` and `PRINT` statements for which no edit mask is specified, and for which no `DF` parameter applies.

For date fields which are displayed by `INPUT`, `DISPLAY`, `PRINT` and `WRITE` statements and for which neither an edit mask is specified nor a `DF` parameter applies, the profile/session parameter `DFOUT` determines the format in which the field values are displayed.

Possible `DFOUT` settings are:

|         |                                                                                                                                       |
|---------|---------------------------------------------------------------------------------------------------------------------------------------|
| DFOUT=S | Date variables are displayed with a 2-digit year component, and delimiters as determined by the DTFORM parameter ( <i>yy-mm-dd</i> ). |
| DFOUT=I | Date variables are displayed with a 4-digit year component and no delimiters ( <i>yyyymmdd</i> ).                                     |

By default, DFOUT=S applies. For either DFOUT setting, the sequence of the day, month and year components in the date values is determined by the DTFORM parameter.

The lengths of the date fields are not affected by the DFOUT setting, as either date value representation fits into an 8-byte field.

The DFOUT parameter can be set in the Natural parameter module/file, dynamically when Natural is invoked, or at session level. It is evaluated at runtime.

**Example:**

This example assumes that DTFORM=I applies.

```

DEFINE DATA LOCAL
1 #DATE (D) INIT <D'2005-12-31'>
END-DEFINE
...
WRITE #DATE          /* Output if DFOUT=S is set ...: 05-12-31
                   /* Output if DFOUT=I is set ...: 20051231
WRITE #DATE (DF=L) /* Output (regardless of DFOUT): 2005-12-31
...

```

## Date Format for Stack - DFSTACK Parameter

---

The session/profile parameter DFSTACK only applies to date fields used in STACK, FETCH and RUN statements for which no DF parameter has been specified.

The DFSTACK parameter determines the format in which the values of date variables are placed on the stack via a STACK, RUN or FETCH statement.

Possible DFSTACK settings are:

|           |                                                                                                                                                         |
|-----------|---------------------------------------------------------------------------------------------------------------------------------------------------------|
| DFSTACK=S | Date variables are placed on the stack with a 2-digit year component, and delimiters as determined by the profile parameter DTFORM ( <i>yy-mm-dd</i> ). |
| DFSTACK=C | Same as DFSTACK=S. However, a change in the century will be intercepted at runtime.                                                                     |
| DFSTACK=I | Date variables are placed on the stack with a 4-digit year component and no delimiters ( <i>yyyymmdd</i> ).                                             |

By default, DFSTACK=S applies. DFSTACK=S means that when a date value is placed on the stack, it is placed there without the century information (which is lost). When the value is then read from the stack and placed into another date variable, the century is either assumed to be the current



one or determined by the setting of the `YSLW` parameter (see [below](#)). This might lead to the century being different from that of the original date value; however, Natural would not issue any error in this case.

`DFSTACK=C` works the same as `DFSTACK=S` in that a date value is placed on the stack without the century information. However, if the value is read from the stack and the resulting century is different from that of the original date value (either because of the `YSLW` parameter, or the original century not being the current one), Natural issues a runtime error.



**Note:** This runtime error is already issued at the time when the value is placed on the stack.

`DFSTACK=I` allows you to place a date value on the stack in a length of 8 bytes without losing the century information.

The `DFSTACK` parameter can be set in the Natural parameter module/file, dynamically when Natural is invoked, or at session level. It is evaluated at runtime.

### Example:

This example assumes that `DTFORM=I` and `YSLW=0` apply.

```
DEFINE DATA LOCAL
  1 #DATE (D) INIT <D'2005-12-31'>
  1 #ALPHA1(A8)
  1 #ALPHA2(A10)
END-DEFINE
...
STACK TOP DATA #DATE #DATE (DF=L)
...
INPUT #ALPHA1 #ALPHA2
...
/* Result if DFSTACK=S or =C is set: #ALPHA1 contains 05-12-31
/* Result if DFSTACK=I is set .....: #ALPHA1 contains 20051231
/* Result (regardless of DFSTACK) .: #ALPHA2 contains 2005-12-31
...
```

## Year Sliding Window - YSLW Parameter

The profile parameter `YSLW` allows you determine the century of a 2-digit year value.

The `YSLW` parameter can be set in the Natural parameter module/file or dynamically when Natural is invoked. It is evaluated at runtime when an alphanumeric date value with a 2-digit year component is moved into a date variable. This applies to data values which are:

- used with the [mathematical function](#) `VAL(field)`,
- used with the `IS(D)` option in a logical condition,

- read from the **stack** as input data, or
- entered in an input field as input data.

The `YSLW` parameter determines the range of years covered by a so-called “year sliding window”. The sliding-window mechanism assumes a date with a 2-digit year to be within a “window” of 100 years. Within these 100 years, every 2-digit year value can be uniquely related to a specific century.

With the `YSLW` parameter, you determine how many years in the past that 100-year range is to begin: The `YSLW` value is subtracted from the current year to determine the first year of the window range.

Possible values of the `YSLW` parameter are 0 to 99. The default value is `YSLW=0`, which means that no sliding-window mechanism is used; that is, a date with a 2-digit year is assumed to be in the current century.

**Example 1:**

If the current year is 2005 and you specify `YSLW=40`, the sliding window will cover the years 1965 to 2064. A 2-digit year value `nn` from 65 to 99 is interpreted accordingly as `19nn`, while a 2-digit year value `nn` from 00 to 64 is interpreted as `20nn`.

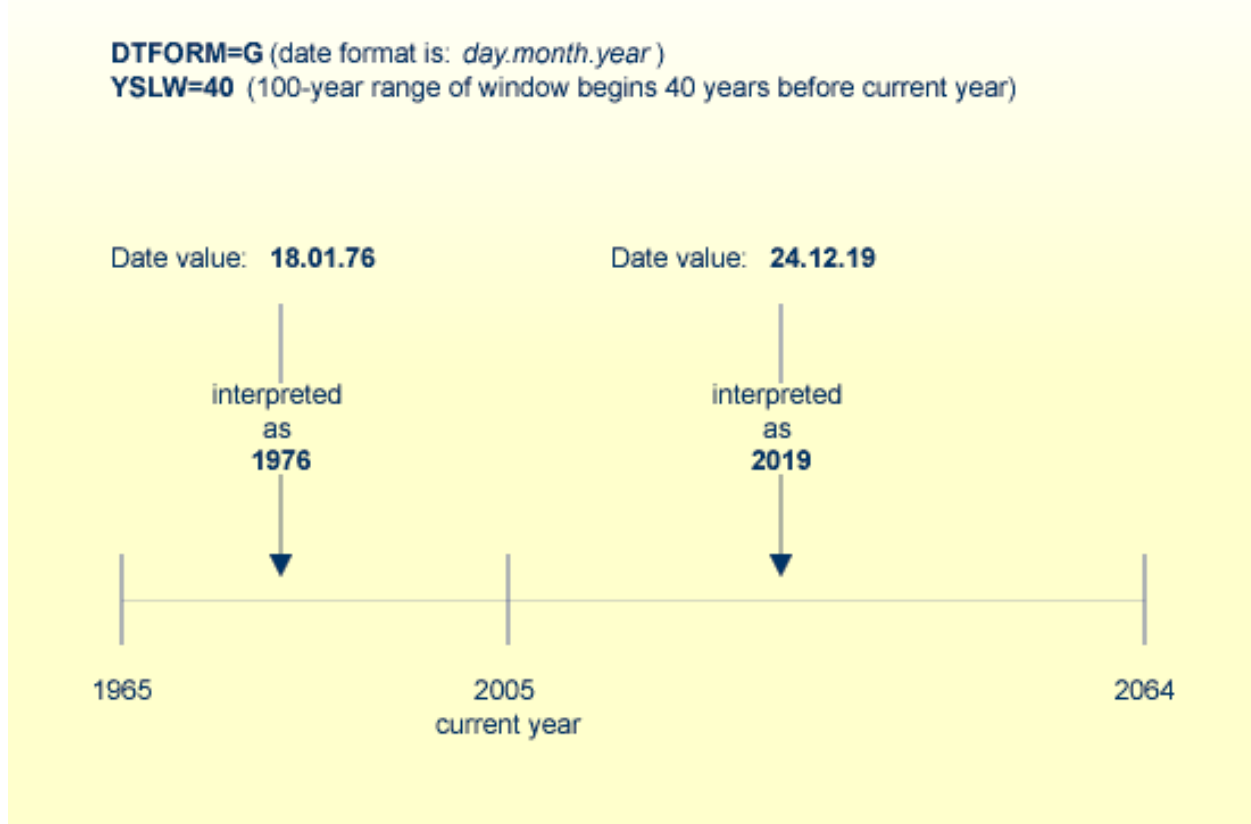

**Example 2:**

If the current year is 2005 and you specify `YSLW=20`, the sliding window will cover the years 1985 to 2084. A 2-digit year value `nn` from 85 to 99 is interpreted accordingly as `19nn`, while a 2-digit year value `nn` from 00 to 84 is interpreted as `20nn`.

**DTFORM=G** (date format is: *day.month.year*)  
**YSLW=20** (100-year range of window begins 20 years before current year)

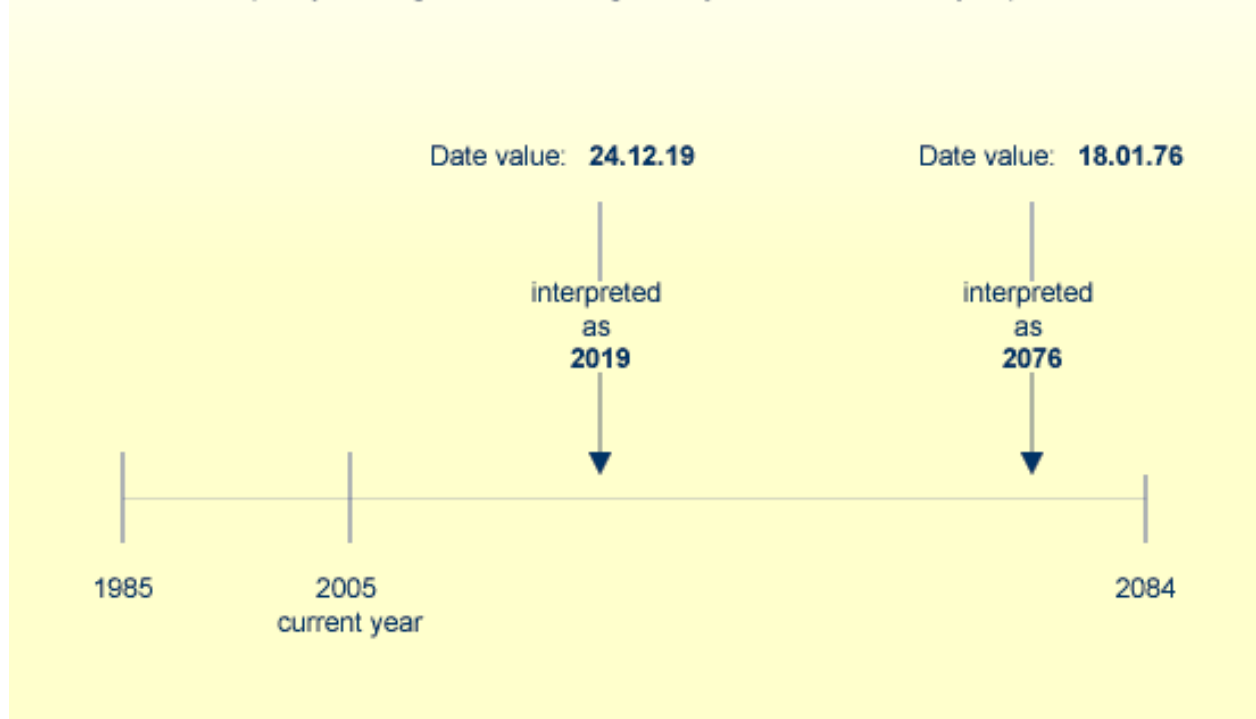

## Combinations of DFSTACK and YSLW

The following examples illustrate the effects of using various combinations of the parameters `DFSTACK` and `YSLW`.



**Note:** All these examples assume that `DTFORM=I` applies.

**Example 1:**

This example assumes the current year to be 2005, and that the parameter settings `DFSTACK=S` (default) and `YSLW=20` apply.

```
DEFINE DATA LOCAL
  1 #DATE1 (D) INIT <D'1956-12-31'>
  1 #DATE2 (D)
END-DEFINE
...
STACK TOP DATA #DATE1 /* century information is lost (year 56 is stacked)
...
INPUT #DATE2           /* year sliding window determines 56 to be 2056
...
/* Result: #DATE2 contains 2056-12-31
           even if #DATE1 is set to <D'2156-12-31'>
```

In this case, the year sliding window is not set appropriately, so that the century information is (inadvertently) changed.

### Example 2:

This example assumes the current year to be 2005, and that the parameter settings `DFSTACK=S` (default) and `YSLW=60` apply.

```
DEFINE DATA LOCAL
  1 #DATE1 (D) INIT <D'1956-12-31'>
  1 #DATE2 (D)
END-DEFINE
...
STACK TOP DATA #DATE1 /* century information is lost (year 56 is stacked)
...
INPUT #DATE2           /* year sliding window determines 56 to be 1956
...
/* Result: #DATE2 contains 1956-12-31
           even if #DATE1 is set to <D'2056-12-31'>
```

In this case, the year sliding window is set appropriately, so that the original century information is correctly restored.

### Example 3:

This example assumes the current year to be 2005, and that the parameter settings `DFSTACK=C` and `YSLW=0` (default) apply.

```
DEFINE DATA LOCAL
  1 #DATE1 (D) INIT <D'1956-12-31'>
  1 #DATE2 (D)
END-DEFINE
...
STACK TOP DATA #DATE1 /* century information is lost (year 56 is stacked)
...
INPUT #DATE2           /* 56 is assumed to be in current century -> 1956
```

```
...
/* Result: RUNTIME ERROR (UNINTENDED CENTURY CHANGE)
```

In this case, the century information is (inadvertently) changed. However, this change is intercepted by the `DFSTACK=C` setting.

#### Example 4:

This example assumes the current year to be 2005, and that the parameter settings `DFSTACK=C` and `YSLW=60` (default) apply.

```
DEFINE DATA LOCAL
  1 #DATE1 (D) INIT <D'2056-12-31'>
  1 #DATE2 (D)
END-DEFINE
...
STACK TOP DATA #DATE1 /* century information is lost (year 56 is stacked)
...
INPUT #DATE2           /* year sliding window determines 56 to be 1956
...
/* Result: RUNTIME ERROR (UNINTENDED CENTURY CHANGE)
```

In this case, the century information is changed due to the year sliding window. However, this change is intercepted by the `DFSTACK=C` setting.

## Year Fixed Window

For information on this topic, see the description of the profile parameter `YSLW`.

## Date Format for Default Page Title - DFTITLE Parameter

The session/profile parameter `DFTITLE` determines the format of the date in a default **page title** (as output with a `DISPLAY`, `WRITE` or `PRINT` statement).

|                        |                                                                                         |
|------------------------|-----------------------------------------------------------------------------------------|
| <code>DFTITLE=S</code> | The date is output with a 2-digit year component and delimiters ( <i>yy-mm-dd</i> ).    |
| <code>DFTITLE=L</code> | The date is output with a 4-digit year component and delimiters ( <i>yyyy-mm-dd</i> ).  |
| <code>DFTITLE=I</code> | The date is output with a 4-digit year component and no delimiters ( <i>yyyymmdd</i> ). |

For each of these output formats, the sequence of the day, month and year components, and the delimiter characters used, are determined by the `DTFORM` parameter.

The `DFTITLE` parameter can be set in the Natural parameter module/file, dynamically when Natural is invoked, or at session level. It is evaluated at runtime.

**Example:**

This example assumes that DTFORM=I applies.

```
WRITE 'HELLO'  
END  
/*  
/* Date in page title if DFTITLE=S is set ...: 05-10-31  
/* Date in page title if DFTITLE=L is set ...: 2005-10-31  
/* Date in page title if DFTITLE=I is set ...: 20051031
```



**Note:** The DFTITLE parameter has no effect on a user-defined page title as specified with a `WRITE TITLE` statement.

# 44 Text Notation

---

- Defining a Text to Be Used with a Statement - the 'text' Notation ..... 418
- Defining a Character to Be Displayed n Times before a Field Value - the 'c'(n) Notation ..... 419

In an INPUT, DISPLAY, WRITE, WRITE TITLE or WRITE TRAILER statement, you can use text notation to define a text to be used in conjunction with such a statement.

## Defining a Text to Be Used with a Statement - the 'text' Notation

---

The text to be used with the statement (for example, a prompting message) must be enclosed in either apostrophes (') or quotation marks ("). Do not confuse double apostrophes (") with a quotation mark (").

Text enclosed in quotation marks can be converted automatically from lower-case letters to upper case. To switch off automatic conversion, change the settings in the editor profile.

The text itself may be 1 to 72 characters and must not be continued from one line to the next.

Text elements may be concatenated by using a hyphen.

### Examples:

```
DEFINE DATA LOCAL
1 #A(A10)
END-DEFINE

INPUT 'Input XYZ' (CD=BL) #A
WRITE '=' #A
WRITE 'Write1 ' - 'Write2 ' - 'Write3' (CD=RE)
END
```

### Using Apostrophes as Part of a Text String

The following applies, if Natural profile parameter TQMARK (Translate Quotation Marks) is set to ON. This is the default setting.

If you want an apostrophe to be part of a text string that is enclosed in apostrophes, you must write this as double apostrophes (") or as a quotation mark ("). Either notation will be output as a single apostrophe.

If you want an apostrophe to be part of a text string that is enclosed in quotation marks, you write this as a single apostrophe.



**Examples of Apostrophe:**

```
#FIELDA = 'O' 'CONNOR'
#FIELDA = 'O"CONNOR'
#FIELDA = "O'CONNOR"
```

In all three cases, the result will be:

```
O'CONNOR
```

**Using Quotation Marks as Part of a Text String**

The following applies, if the Natural profile parameter TQ (Translate Quotation Marks) is set to OFF. The default setting is TQ=ON.

If you want a quotation mark to be part of a text string that is enclosed in single apostrophes, write a quotation mark.

If you want a quotation mark to be part of a text string that is enclosed in quotation marks, write double quotation marks ("").

**Example of Quotation Mark:**

```
#FIELDA = 'O"CONNOR'
#FIELDA = "O""CONNOR"
```

In both cases, the result will be:

```
O"CONNOR
```

**Defining a Character to Be Displayed n Times before a Field Value - the 'c'(n) Notation**

If a single character is to be output several times as text, you use the following notation:

```
'c'(n)
```

As *c* you specify the character, and as *n* the number of times the character is to be generated. The maximum value for *n* is 249.

**Example:**

```
WRITE '*'(3)
```

Instead of apostrophes before and after the character `c` you can also use quotation marks.

# 45

## User Comments

---

- Using an Entire Source Code Line for Comments ..... 422
- Using the Latter Part of a Source Code Line for Comments ..... 423

User comments are descriptions or explanatory notes added to or interspersed among the statements of the source code. Such information may be particularly helpful in understanding and maintaining source code that was written or edited by another programmer. Also, the characters marking the beginning of a comment can be used to temporarily disable the function of a statement or several source code lines for test purposes.

## Using an Entire Source Code Line for Comments

---

If you wish to use an entire source-code line for a user comment, you enter one of the following at the beginning of the line:

- an asterisk and a blank (\* ),
- two asterisks (\*\*), or
- a slash and an asterisk (/\*\*).

```
*  USER COMMENT
** USER COMMENT
/* USER COMMENT
```

### Example:

As can be seen from the following example, comment lines may also be used to provide for a clear source code structure.

```
** Example 'LOGICX03': BREAK option in logical condition
*****
DEFINE DATA LOCAL
1 EMPLOY-VIEW VIEW OF EMPLOYEES
  2 NAME
  2 FIRST-NAME
  2 BIRTH
*
1 #BIRTH (A8)
END-DEFINE
*
LIMIT 10
READ EMPLOY-VIEW BY BIRTH
  MOVE EDITED BIRTH (EM=YYYYMMDD) TO #BIRTH
  /*
  IF BREAK OF #BIRTH /6/
    NEWPAGE IF LESS THAN 5 LINES LEFT
    WRITE / '- ' (50) /
  END-IF
  /*
  DISPLAY NOTITLE BIRTH (EM=YYYY-MM-DD) NAME FIRST-NAME
```

```
END-READ
END
```

## Using the Latter Part of a Source Code Line for Comments

If you wish to use only the latter part of a source-code line for a user comment, you enter a blank, a slash and an asterisk (/); the remainder of the line after this notation is thus marked as a comment:

```
ADD 5 TO #A          /* USER COMMENT
```

### Example:

```
** Example 'LOGICX04': IS option as format/length check
*****
DEFINE DATA LOCAL
1 #FIELDA (A10)          /* INPUT FIELD TO BE CHECKED
1 #FIELDB (N5)           /* RECEIVING FIELD OF VAL FUNCTION
1 #DATE (A10)           /* INPUT FIELD FOR DATE
END-DEFINE
*
INPUT #DATE #FIELDA
IF #DATE IS(D)
  IF #FIELDA IS (N5)
    COMPUTE #FIELDB = VAL(#FIELDA)
    WRITE NOTITLE 'VAL FUNCTION OK' // '=' #FIELDA '=' #FIELDB
  ELSE
    REINPUT 'FIELD DOES NOT FIT INTO N5 FORMAT'
    MARK *#FIELDA
  END-IF
ELSE
  REINPUT 'INPUT IS NOT IN DATE FORMAT (YY-MM-DD) '
  MARK *#DATE
END-IF
*
END
```



# 46

## Logical Condition Criteria

---

- Introduction ..... 426
- Relational Expression ..... 427
- Extended Relational Expression ..... 431
- Evaluation of a Logical Variable ..... 432
- Fields Used within Logical Condition Criteria ..... 433
- Logical Operators in Complex Logical Expressions ..... 435
- BREAK Option - Compare Current Value with Value of Previous Loop Pass ..... 436
- IS Option - Check whether Content of Alphanumeric or Unicode Field can be Converted ..... 438
- MASK Option - Check Selected Positions of a Field for Specific Content ..... 440
- MASK Option Compared with IS Option ..... 447
- MODIFIED Option - Check whether Field Content has been Modified ..... 449
- SCAN Option - Scan for a Value within a Field ..... 450
- SPECIFIED Option - Check whether a Value is Passed for an Optional Parameter ..... 452

This chapter describes purpose and use of logical condition criteria that can be used in the statements FIND, READ, HISTOGRAM, ACCEPT/REJECT, IF, DECIDE FOR, REPEAT.

## Introduction

---

The basic criterion is a **relational expression**. Multiple relational expressions may be combined with logical operators (AND, OR) to form complex criteria.

Arithmetic expressions may also be used to form a relational expression.

Logical condition criteria can be used in the following statements:

| Statement     | Usage                                                                                                                                                                                                                                                                                                                                                                                                                              |
|---------------|------------------------------------------------------------------------------------------------------------------------------------------------------------------------------------------------------------------------------------------------------------------------------------------------------------------------------------------------------------------------------------------------------------------------------------|
| FIND          | A WHERE clause containing logical condition criteria may be used to indicate criteria in addition to the basic selection criteria as specified in the WITH clause. The logical condition criteria specified with the WHERE clause are evaluated after the record has been selected and read.<br><br>In a WITH clause, “basic search criteria” (as described with the FIND statement) are used, but not logical condition criteria. |
| READ          | A WHERE clause containing logical condition criteria may be used to specify whether a record that has just been read is to be processed. The logical condition criteria are evaluated after the record has been read.                                                                                                                                                                                                              |
| HISTOGRAM     | A WHERE clause containing logical condition criteria may be used to specify whether the value that has just been read is to be processed. The logical condition criteria are evaluated after the value has been read.                                                                                                                                                                                                              |
| ACCEPT/REJECT | An IF clause may be used with an ACCEPT or REJECT statement to specify logical condition criteria in addition to that specified when the record was selected/read with a FIND, READ, or HISTOGRAM statement. The logical condition criteria are evaluated after the record has been read and after record processing has started.                                                                                                  |
| IF            | Logical condition criteria are used to control statement execution.                                                                                                                                                                                                                                                                                                                                                                |
| DECIDE FOR    | Logical condition criteria are used to control statement execution.                                                                                                                                                                                                                                                                                                                                                                |
| REPEAT        | The UNTIL or WHILE clause of a REPEAT statement contain logical condition criteria which determine when a processing loop is to be terminated.                                                                                                                                                                                                                                                                                     |



# Relational Expression

Syntax:

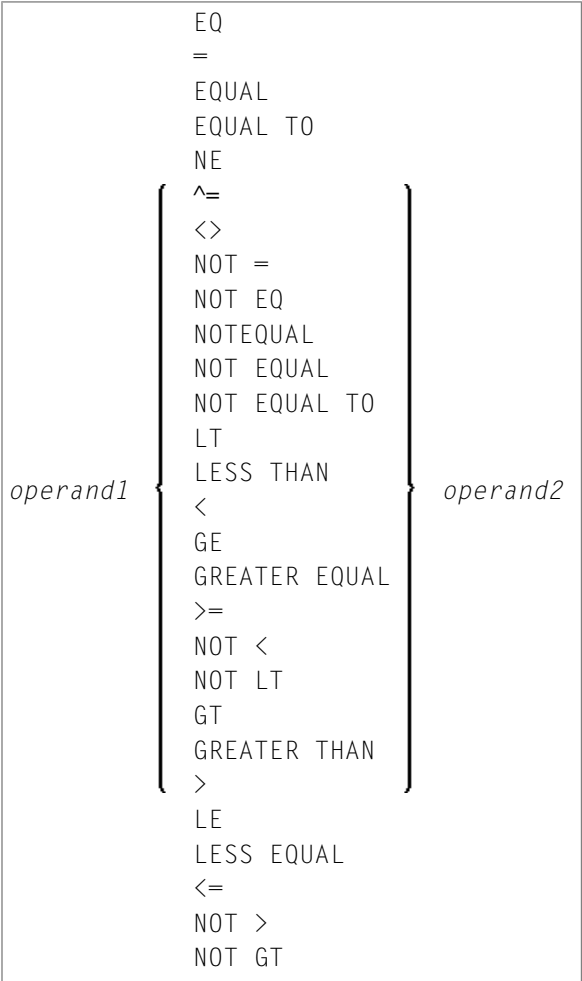

Operand Definition Table:

| Operand         | Possible Structure |   |   |  | Possible Formats |   |   |   |   |   |   |   |   |   | Referencing Permitted | Dynamic Definition |   |   |     |     |
|-----------------|--------------------|---|---|--|------------------|---|---|---|---|---|---|---|---|---|-----------------------|--------------------|---|---|-----|-----|
| <i>operand1</i> | C                  | S | A |  | N                | E | A | U | N | P | I | F | B | D | T                     | L                  | G | O | yes | yes |
| <i>operand2</i> | C                  | S | A |  | N                | E | A | U | N | P | I | F | B | D | T                     | L                  | G | O | yes | no  |

For an explanation of the Operand Definition Table shown above, see *Syntax Symbols and Operand Definition Tables* in the *Statements* documentation.

In the “Possible Structure” column of the table above, “E” stands for arithmetic expressions; that is, any arithmetic expression may be specified as an operand within the relational expression. For

further information on arithmetic expressions, see *arithmetic-expression* in the COMPUTE statement description.

Explanation of the comparison operators:

| Comparison Operator                                                        | Explanation              |
|----------------------------------------------------------------------------|--------------------------|
| EQ<br>=<br>EQUAL<br>EQUAL TO                                               | equal to                 |
| NE<br>^=<br><><br>NOT =<br>NOT EQ<br>NOTEQUAL<br>NOT EQUAL<br>NOT EQUAL TO | not equal to             |
| LT<br>LESS THAN<br><                                                       | less than                |
| GE<br>GREATER EQUAL<br>>=                                                  | greater than or equal to |
| NOT <<br>NOT LT                                                            | not less than            |
| GT<br>GREATER THAN<br>>                                                    | greater than             |
| LE<br>LESS EQUAL<br><=                                                     | less than or equal to    |
| NOT ><br>NOT GT                                                            | not greater than         |

**Examples of Relational Expressions:**

```
IF NAME = 'SMITH'
IF LEAVE-DUE GT 40
IF NAME = #NAME
```

For information on comparing arrays in a relational expression, see *Processing of Arrays*.



**Note:** If a floating-point operand is used, comparison is performed in floating point. **Floating-point numbers** as such have only a limited precision; therefore, rounding/truncation

errors cannot be precluded when numbers are converted to/from floating-point representation.

### Arithmetic Expressions in Logical Conditions

The following example shows how arithmetic expressions can be used in logical conditions:

```
IF #A + 3 GT #B - 5 AND #C * 3 LE #A + #B
```

### Handles in Logical Conditions

If the operands in a relation expression are handles, only EQUAL and NOT EQUAL operators may be used.

### SUBSTRING Option in Relational Expression

Syntax:

|                                                                                                                                            |                                                                                                                                                                                                                                                                                                                                                      |                                                                                                                                            |
|--------------------------------------------------------------------------------------------------------------------------------------------|------------------------------------------------------------------------------------------------------------------------------------------------------------------------------------------------------------------------------------------------------------------------------------------------------------------------------------------------------|--------------------------------------------------------------------------------------------------------------------------------------------|
| $\left\{ \begin{array}{l} \text{SUBSTRING} \\ (\text{operand1}, \text{operand3}, \text{operand4}) \\ \text{operand1} \end{array} \right\}$ | $\left\{ \begin{array}{l} = \\ \text{EQ} \\ \text{EQUAL [T0]} \\ <> \\ \text{NE} \\ \text{NOT =} \\ \text{NOT EQ} \\ \text{NOT EQUAL} \\ \text{NOT EQUAL TO} \\ < \\ \text{LT} \\ \text{LESS THAN} \\ <= \\ \text{LE} \\ \text{LESS EQUAL} \\ > \\ \text{GT} \\ \text{GREATER THAN} \\ >= \\ \text{GE} \\ \text{GREATER EQUAL} \end{array} \right\}$ | $\left\{ \begin{array}{l} \text{operand2} \\ \text{SUBSTRING} \\ (\text{operand2}, \text{operand5}, \text{operand6}) \end{array} \right\}$ |
|--------------------------------------------------------------------------------------------------------------------------------------------|------------------------------------------------------------------------------------------------------------------------------------------------------------------------------------------------------------------------------------------------------------------------------------------------------------------------------------------------------|--------------------------------------------------------------------------------------------------------------------------------------------|

Operand Definition Table:

| Operand         | Possible Structure |   |   |   | Possible Formats |   |  |   |   |   |   |  |  |  | Referencing Permitted | Dynamic Definition |     |
|-----------------|--------------------|---|---|---|------------------|---|--|---|---|---|---|--|--|--|-----------------------|--------------------|-----|
| <i>operand1</i> | C                  | S | A | N | A                | U |  |   |   |   | B |  |  |  |                       | yes                | yes |
| <i>operand2</i> | C                  | S | A | N | A                | U |  |   |   |   | B |  |  |  |                       | yes                | no  |
| <i>operand3</i> | C                  | S |   |   |                  |   |  | N | P | I | B |  |  |  |                       | yes                | no  |
| <i>operand4</i> | C                  | S |   |   |                  |   |  | N | P | I |   |  |  |  |                       | yes                | no  |
| <i>operand5</i> | C                  | S |   |   |                  |   |  | N | P | I |   |  |  |  |                       | yes                | no  |
| <i>operand6</i> | C                  | S |   |   |                  |   |  | N | P | I |   |  |  |  |                       | yes                | no  |

With the `SUBSTRING` option, you can compare a *part* of an alphanumeric, a binary or a Unicode field. After the field name (*operand1*) you specify first the starting position (*operand3*) and then the **length** (*operand4*) of the field portion to be compared.

Also, you can compare a field value with part of another field value. After the field name (*operand2*) you specify first the starting position (*operand5*) and then the length (*operand6*) of the field portion *operand1* is to be compared with.

You can also combine both forms, that is, you can specify a `SUBSTRING` for both *operand1* and *operand2*.

**Examples:**

The following expression compares the 5th to 12th position inclusive of the value in field #A with the value of field #B:

```
SUBSTRING(#A,5,8) = #B
```

- where 5 is the starting position and 8 is the length.

The following expression compares the value of field #A with the 3rd to 6th position inclusive of the value in field #B:

```
#A = SUBSTRING(#B,3,4)
```

 **Note:** If you omit *operand3/operand5*, the starting position is assumed to be 1. If you omit *operand4/operand6*, the length is assumed to be from the starting position to the end of the field.

## Extended Relational Expression

Syntax:

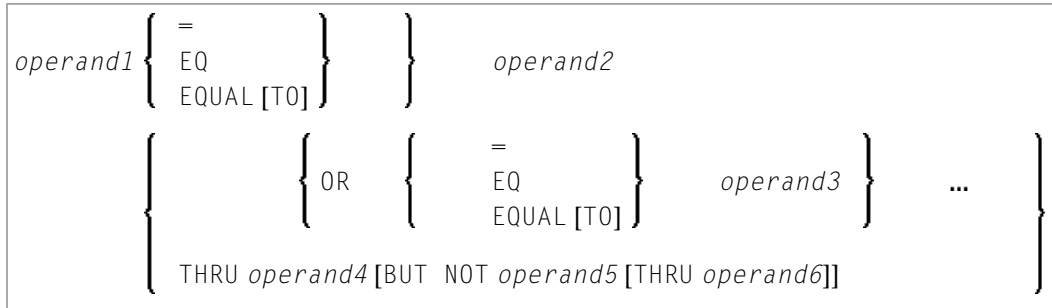

Operand Definition Table:

| Operand         | Possible Structure | Possible Formats       | Referencing Permitted | Dynamic Definition |
|-----------------|--------------------|------------------------|-----------------------|--------------------|
| <i>operand1</i> | C S A              | N* E A U N P I F B D T | yes                   | no                 |
| <i>operand2</i> | C S A              | N* E A U N P I F B D T | yes                   | no                 |
| <i>operand3</i> | C S A              | N* E A U N P I F B D T | yes                   | no                 |
| <i>operand4</i> | C S A              | N* E A U N P I F B D T | yes                   | no                 |
| <i>operand5</i> | C S A              | N* E A U N P I F B D T | yes                   | no                 |
| <i>operand6</i> | C S A              | N* E A U N P I F B D T | yes                   | no                 |

\* Mathematical functions and system variables are permitted. Break functions are not permitted.

*operand3* can also be specified using a MASK or SCAN option; that is, it can be specified as:

```

MASK (mask-definition) [operand]
MASK operand
SCAN operand
    
```

For details on these options, see the sections [MASK Option](#) and [SCAN Option](#).

**Examples:**

```
IF #A = 2 OR = 4 OR = 7
IF #A = 5 THRU 11 BUT NOT 7 THRU 8
```

## Evaluation of a Logical Variable

---

Syntax:

```
operand1
```

This option is used in conjunction with a logical variable (format L). A logical variable may take the value TRUE or FALSE. As *operand1* you specify the name of the logical variable to be used.

Operand Definition Table:

| Operand         | Possible Structure | Possible Formats | Referencing Permitted | Dynamic Definition |
|-----------------|--------------------|------------------|-----------------------|--------------------|
| <i>operand1</i> | C S A              | L                | no                    | no                 |

**Example of Logical Variable:**

```
** Example 'LOGICX05': Logical variable in logical condition
*****
DEFINE DATA LOCAL
1 #SWITCH (L) INIT <true>
1 #INDEX (I1)
END-DEFINE
*
FOR #INDEX 1 5
  WRITE NOTITLE #SWITCH (EM=FALSE/TRUE) 5X 'INDEX =' #INDEX
  WRITE NOTITLE #SWITCH (EM=OFF/ON) 7X 'INDEX =' #INDEX
  IF #SWITCH
    MOVE FALSE TO #SWITCH
  ELSE
    MOVE TRUE TO #SWITCH
  END-IF
/*
  SKIP 1
END-FOR
END
```

Output of Program LOGICX05:

|       |         |   |
|-------|---------|---|
| TRUE  | INDEX = | 1 |
| ON    | INDEX = | 1 |
| FALSE | INDEX = | 2 |
| OFF   | INDEX = | 2 |
| TRUE  | INDEX = | 3 |
| ON    | INDEX = | 3 |
| FALSE | INDEX = | 4 |
| OFF   | INDEX = | 4 |
| TRUE  | INDEX = | 5 |
| ON    | INDEX = | 5 |

## Fields Used within Logical Condition Criteria

Database fields and user-defined variables may be used to construct logical condition criteria. A database field which is a multiple-value field or is contained in a periodic group can also be used. If a range of values for a multiple-value field or a range of occurrences for a periodic group is specified, the condition is true if the search value is found in any value/occurrence within the specified range.

Each value used must be compatible with the field used on the opposite side of the expression. Decimal notation may be specified only for values used with numeric fields, and the number of decimal positions of the value must agree with the number of decimal positions defined for the field.

If the operands are not of the same format, the second operand is converted to the format of the first operand.



**Note:** A numeric constant without decimal point notation is stored with format I for the values -2147483648 to +2147483647, see [Numeric Constants](#). Consequently the comparison with such an integer constant as *operand1* is performed by converting *operand2* to a integer value. This means that the digits after the decimal point of *operand2* are not considered due to truncation.

Example:

```

IF 0 = 0.5      /* is true because 0.5 (operand2) is converted to 0 (format I of ←
operand1)
IF 0.0 = 0.5   /* is false
IF 0.5 = 0     /* is false
IF 0.5 = 0.0   /* is false ←
    
```

The following table shows which operand formats can be used together in a logical condition:

| operand1  | operand2 |   |           |           |   |   |   |   |   |   |   |    |    |
|-----------|----------|---|-----------|-----------|---|---|---|---|---|---|---|----|----|
|           | A        | U | Bn (n<=4) | Bn (n>=5) | D | T | I | F | L | N | P | GH | OH |
| A         | Y        | Y | Y         | Y         |   |   |   |   |   |   |   |    |    |
| U         | Y        | Y | [2]       | [2]       |   |   |   |   |   |   |   |    |    |
| Bn (n<=4) | Y        | Y | Y         | Y         | Y | Y | Y | Y | Y | Y | Y |    |    |
| Bn (n>=5) | Y        | Y | Y         | Y         |   |   |   |   |   |   |   |    |    |
| D         |          |   | Y         |           | Y | Y | Y | Y | Y | Y | Y |    |    |
| T         |          |   | Y         |           | Y | Y | Y | Y | Y | Y | Y |    |    |
| I         |          |   | Y         |           | Y | Y | Y | Y | Y | Y | Y |    |    |
| F         |          |   | Y         |           | Y | Y | Y | Y | Y | Y | Y |    |    |
| L         |          |   |           |           |   |   |   |   |   |   |   |    |    |
| N         |          |   | Y         |           | Y | Y | Y | Y | Y | Y | Y |    |    |
| P         |          |   | Y         |           | Y | Y | Y | Y | Y | Y | Y |    |    |
| GH [1]    |          |   |           |           |   |   |   |   |   |   |   | Y  |    |
| OH [1]    |          |   |           |           |   |   |   |   |   |   |   |    | Y  |



**Notes:**

- [1] where GH = GUI handle, OH = object handle.
- [2] The binary value will be assumed to contain Unicode code points, and the comparison is performed as for a comparison of two Unicode values. The length of the binary field must be even.

If two values are compared as alphanumeric values, the shorter value is assumed to be extended with trailing blanks in order to get the same length as the longer value.

If two values are compared as binary values, the shorter value is assumed to be extended with leading binary zeroes in order to get the same length as the longer value.

If two values are compared as Unicode values, trailing blanks are removed from both values before the ICU collation algorithm is used to compare the two resulting values. See also *Logical Condition Criteria* in the *Unicode and Code Page Support* documentation.



**Comparison Examples:**

```

A1(A1) := 'A'
A5(A5) := 'A      '
B1(B1) := H'FF'
B5(B5) := H'00000000FF'
U1(U1) := UH'00E4'
U2(U2) := UH'00610308'
IF A1 = A5 THEN ...           /* TRUE
IF B1 = B5 THEN ...           /* TRUE
IF U1 = U2 THEN ...           /* TRUE ↵

```

If an array is compared with a scalar value, each element of the array will be compared with the scalar value. The condition will be true if at least one of the array elements meets the condition (OR operation).

If an array is compared with an array, each element in the array is compared with the corresponding element of the other array. The result is true only if all element comparisons meet the condition (AND operation).

See also [Processing of Arrays](#).



**Note:** An Adabas phonetic descriptor cannot be used within a logical condition.

**Examples of Logical Condition Criteria:**

```

FIND EMPLOYEES-VIEW WITH CITY = 'BOSTON' WHERE SEX = 'M'
READ EMPLOYEES-VIEW BY NAME WHERE SEX = 'M'
ACCEPT IF LEAVE-DUE GT 45
IF #A GT #B THEN COMPUTE #C = #A + #B
REPEAT UNTIL #X = 500

```

**Logical Operators in Complex Logical Expressions**

Logical condition criteria may be combined using the Boolean operators AND, OR, and NOT. Parentheses may also be used to indicate logical grouping.

The operators are evaluated in the following order:

| Priority | Operator | Meaning       |
|----------|----------|---------------|
| 1        | ( )      | Parentheses   |
| 2        | NOT      | Negation      |
| 3        | AND      | AND operation |
| 4        | OR       | OR operation  |

The following *logical-condition-criteria* may be combined by logical operators to form a complex *logical-expression*:

- **Relational expressions**
- **Extended relational expressions**
- **MASK option**
- **SCAN option**
- **BREAK option**

The syntax for a *logical-expression* is as follows:

```
[NOT] { logical-condition-criterion } [ { OR } logical-expression ] ...
      { (logical-expression) } [ { AND } logical-expression ] ...
```

**Examples of Logical Expressions:**

```
FIND STAFF-VIEW WITH CITY = 'TOKYO'
  WHERE BIRTH GT 19610101 AND SEX = 'F'
IF NOT (#CITY = 'A' THRU 'E')
```

For information on comparing arrays in a logical expression, see [Processing of Arrays](#).

 **Note:** If multiple logical-condition-criteria are connected with AND, the evaluation terminates as soon as the first of these criteria is not true.

---

## BREAK Option - Compare Current Value with Value of Previous Loop Pass

The BREAK option allows the current value or a portion of a value of a field to be compared with the value contained in the same field in the previous pass through the processing loop.

Syntax:

BREAK [OF] *operand1* [/n/]

Operand Definition Table:

| Operand         | Possible Structure | Possible Formats    | Referencing Permitted | Dynamic Definition |
|-----------------|--------------------|---------------------|-----------------------|--------------------|
| <i>operand1</i> | S                  | A U N P I F B D T L | yes                   | no                 |

Syntax Element Description:

|                 |                                                                                                                                                                                                                                                                                                                                                                                                                                                                                                                                                                                                                                                                                                                                                        |
|-----------------|--------------------------------------------------------------------------------------------------------------------------------------------------------------------------------------------------------------------------------------------------------------------------------------------------------------------------------------------------------------------------------------------------------------------------------------------------------------------------------------------------------------------------------------------------------------------------------------------------------------------------------------------------------------------------------------------------------------------------------------------------------|
| <i>operand1</i> | Specifies the control field which is to be checked. A specific occurrence of an array can also be used as a control field.                                                                                                                                                                                                                                                                                                                                                                                                                                                                                                                                                                                                                             |
| <i>/n/</i>      | <p>The notation <i>/n/</i> may be used to indicate that only the first <i>n</i> positions (counting from left to right) of the control field are to be checked for a change in value. This notation can only be used with operands of format A, B, N, or P.</p> <p>The result of the BREAK operation is true when a change in the specified positions of the field occurs. The result of the BREAK operation is not true if an AT END OF DATA condition occurs.</p> <p>Example:</p> <p>In this example, a check is made for a different value in the first position of the field FIRST-NAME.</p> <pre>BREAK FIRST-NAME /1/</pre> <p>Natural system functions (which are available with the AT BREAK statement) are not available with this option.</p> |

**Example of BREAK Option:**

```
** Example 'LOGICX03': BREAK option in logical condition
*****
DEFINE DATA LOCAL
1 EMPLOY-VIEW VIEW OF EMPLOYEES
  2 NAME
  2 FIRST-NAME
  2 BIRTH
*
1 #BIRTH (A8)
END-DEFINE
*
LIMIT 10
READ EMPLOY-VIEW BY BIRTH
  MOVE EDITED BIRTH (EM=YYYYMMDD) TO #BIRTH
  /*
  IF BREAK OF #BIRTH /6/
    NEWPAGE IF LESS THAN 5 LINES LEFT
    WRITE / '- ' (50) /
```

```
END-IF
/*
DISPLAY NOTITLE BIRTH (EM=YYYY-MM-DD) NAME FIRST-NAME
END-READ
END
```

### Output of Program LOGICX03:

| DATE<br>OF<br>BIRTH | NAME      | FIRST-NAME |
|---------------------|-----------|------------|
| 1940-01-01          | GARRET    | WILLIAM    |
| 1940-01-09          | TAILOR    | ROBERT     |
| 1940-01-09          | PIETSCH   | VENUS      |
| 1940-01-31          | LYTTLETON | BETTY      |
| 1940-02-02          | WINTRICH  | MARIA      |
| 1940-02-13          | KUNEY     | MARY       |
| 1940-02-14          | KOLENCE   | MARSHA     |
| 1940-02-24          | DILWORTH  | TOM        |
| 1940-03-03          | DEKKER    | SYLVIA     |
| 1940-03-06          | STEFFERUD | BILL       |

## IS Option - Check whether Content of Alphanumeric or Unicode Field can be Converted

---

Syntax:

```
operand1 IS (format)
```

This option is used to check whether the content of an alphanumeric or Unicode field (*operand1*) can be converted to a specific other format.

Operand Definition Table:

| Operand         | Possible Structure | Possible Formats | Referencing Permitted | Dynamic Definition |
|-----------------|--------------------|------------------|-----------------------|--------------------|
| <i>operand1</i> | C S A N            | A U              | yes                   | no                 |

The *format* for which the check is performed can be:

|                |                                                                                                                                                                                                                                                                                                                                                                                          |
|----------------|------------------------------------------------------------------------------------------------------------------------------------------------------------------------------------------------------------------------------------------------------------------------------------------------------------------------------------------------------------------------------------------|
| N <i>11.11</i> | Numeric with length <i>11.11</i> .                                                                                                                                                                                                                                                                                                                                                       |
| F <i>11</i>    | Floating point with length <i>11</i> .                                                                                                                                                                                                                                                                                                                                                   |
| D              | Date. The following date formats are possible: <i>dd-mm-yy</i> , <i>dd-mm-yyyy</i> , <i>ddmmyyyy</i> ( <i>dd</i> = day, <i>mm</i> = month, <i>yy</i> or <i>yyyy</i> = year). The sequence of the day, month and year components as well as the characters between the components are determined by the profile parameter DTFORM (which is described in the <i>Parameter Reference</i> ). |
| T              | Time (according to the default time display format).                                                                                                                                                                                                                                                                                                                                     |
| P <i>11.11</i> | Packed numeric with length <i>11.11</i> .                                                                                                                                                                                                                                                                                                                                                |
| I <i>11</i>    | Integer with length <i>11</i> .                                                                                                                                                                                                                                                                                                                                                          |

When the check is performed, leading and trailing blanks in *operand1* will be ignored.

The IS option may, for example, be used to check the content of a field before the mathematical function VAL (extract numeric value from an alphanumeric field) is used to ensure that it will not result in a runtime error.



**Note:** The IS option cannot be used to check if the value of an alphanumeric field is in the specified “format”, but if it can be *converted* to that “format”. To check if a value is in a specific format, you can use the MASK option. For further information, see [MASK Option Compared with IS Option](#) and [Checking Packed or Unpacked Numeric Data](#).

### Example of IS Option:

```

** Example 'LOGICX04': IS option as format/length check
*****
DEFINE DATA LOCAL
1 #FIELDA (A10)          /* INPUT FIELD TO BE CHECKED
1 #FIELDB (N5)          /* RECEIVING FIELD OF VAL FUNCTION
1 #DATE (A10)          /* INPUT FIELD FOR DATE
END-DEFINE
*
INPUT #DATE #FIELDA
IF #DATE IS(D)
  IF #FIELDA IS (N5)
    COMPUTE #FIELDB = VAL(#FIELDA)
    WRITE NOTITLE 'VAL FUNCTION OK' // '=' #FIELDA '=' #FIELDB
  ELSE
    REINPUT 'FIELD DOES NOT FIT INTO N5 FORMAT'
    MARK *#FIELDA
  END-IF
ELSE
  REINPUT 'INPUT IS NOT IN DATE FORMAT (YY-MM-DD) '

```

```
MARK *#DATE  
END-IF  
*  
END
```

Output of Program LOGICX04:

```
#DATE 150487 #FIELDA
```

```
INPUT IS NOT IN DATE FORMAT (YY-MM-DD)
```

## MASK Option - Check Selected Positions of a Field for Specific Content

---

With the MASK option, you can check selected positions of a field for specific content.

The following topics are covered below:

- Constant Mask
- Variable Mask
- Characters in a Mask
- Mask Length
- Checking Dates
- Checking Against the Content of Constants or Variables
- Range Checks
- Checking Packed or Unpacked Numeric Data

### Constant Mask

Syntax:

|            |                                                                                          |                                                     |
|------------|------------------------------------------------------------------------------------------|-----------------------------------------------------|
| $operand1$ | $\left\{ \begin{array}{l} = \\ EQ \\ EQUAL\ TO \\ NE \\ NOT\ EQUAL \end{array} \right\}$ | MASK ( <i>mask-definition</i> ) [ <i>operand2</i> ] |
|------------|------------------------------------------------------------------------------------------|-----------------------------------------------------|

Operand Definition Table:

| Operand         | Possible Structure |   |   |   | Possible Formats |   |   |   |   |  |  |  |  |  |  |  | Referencing Permitted | Dynamic Definition |    |
|-----------------|--------------------|---|---|---|------------------|---|---|---|---|--|--|--|--|--|--|--|-----------------------|--------------------|----|
| <i>operand1</i> | C                  | S | A | N | A                | U | N | P |   |  |  |  |  |  |  |  |                       | yes                | no |
| <i>operand2</i> | C                  | S |   |   | A                | U | N | P | B |  |  |  |  |  |  |  |                       | yes                | no |

*operand2* can only be used if the *mask-definition* contains at least one X. *operand1* and *operand2* must be format-compatible:

- If *operand1* is of format A, *operand2* must be of format A, B, N or U.
- If *operand1* is of format U, *operand2* must be of format A, B, N or U.
- If *operand1* is of format N or P, *operand2* must be of format N or P.

An X in the *mask-definition* selects the corresponding positions of the content of *operand1* and *operand2* for comparison.

### Variable Mask

Apart from a constant *mask-definition* (see above), you may also specify a variable mask definition.

Syntax:

|                 |   |                                        |   |                      |
|-----------------|---|----------------------------------------|---|----------------------|
| <i>operand1</i> | { | =<br>EQ<br>EQUAL TO<br>NE<br>NOT EQUAL | } | MASK <i>operand2</i> |
|-----------------|---|----------------------------------------|---|----------------------|

Operand Definition Table:

| Operand         | Possible Structure |   |   |   | Possible Formats |   |   |   |  |  |  |  |  |  |  |  | Referencing Permitted | Dynamic Definition |    |
|-----------------|--------------------|---|---|---|------------------|---|---|---|--|--|--|--|--|--|--|--|-----------------------|--------------------|----|
| <i>operand1</i> | C                  | S | A | N | A                | U | N | P |  |  |  |  |  |  |  |  |                       | yes                | no |
| <i>operand2</i> |                    | S |   |   | A                | U |   |   |  |  |  |  |  |  |  |  |                       | yes                | no |

The content of *operand2* will be taken as the mask definition. Trailing blanks in *operand2* will be ignored.

- If *operand1* is of format A, N or P, *operand2* must be of format A.
- If *operand1* is of format U, *operand2* must be of format U.

## Characters in a Mask

The following characters may be used within a mask definition (the mask definition is contained in *mask-definition* for a constant mask and *operand2* for a variable mask):

| Character          | Meaning                                                                                                                                                                                                                                                                                                                        |
|--------------------|--------------------------------------------------------------------------------------------------------------------------------------------------------------------------------------------------------------------------------------------------------------------------------------------------------------------------------|
| . or ? or _        | A period, question mark or underscore indicates a single position that is not to be checked.                                                                                                                                                                                                                                   |
| * or %             | An asterisk or percent mark is used to indicate any number of positions not to be checked.                                                                                                                                                                                                                                     |
| /                  | A slash (/) is used to check if a value ends with a specific character (or string of characters).<br><br>For example, the following condition will be true if there is either an E in the last position of the field, or the last E in the field is followed by nothing but blanks:<br><br><pre>IF #FIELD = MASK (*'E'/)</pre> |
| A                  | The position is to be checked for an alphabetical character (upper or lower case).                                                                                                                                                                                                                                             |
| ' c '              | One or more positions are to be checked for the characters bounded by apostrophes (a double apostrophe indicates that a single apostrophe is the character to be checked for). If <i>operand1</i> is in Unicode format, ' c ' must contain Unicode characters.                                                                 |
| C                  | The position is to be checked for an alphabetical character (upper or lower case), a numeric character, or a blank.                                                                                                                                                                                                            |
| DD                 | The two positions are to be checked for a valid day notation (01 - 31; dependent on the values of MM and YY/YYYY, if specified; see also <a href="#">Checking Dates</a> ).                                                                                                                                                     |
| H                  | The position is to be checked for hexadecimal content (A - F, 0 - 9).                                                                                                                                                                                                                                                          |
| JJJ                | The positions are to be checked for a valid Julian Day; that is, the day number in the year (001-366, dependent on the value of YY/YYYY, if specified. See also <a href="#">Checking Dates</a> .)                                                                                                                              |
| L                  | The position is to be checked for a lower-case alphabetical character (a - z).                                                                                                                                                                                                                                                 |
| MM                 | The positions are to be checked for a valid month (01 - 12); see also <a href="#">Checking Dates</a> .                                                                                                                                                                                                                         |
| N                  | The position is to be checked for a numeric digit.                                                                                                                                                                                                                                                                             |
| n . . .            | One (or more) positions are to be checked for a numeric value in the range 0 - n.                                                                                                                                                                                                                                              |
| n1 - n2 or n1 : n2 | The positions are checked for a numeric value in the range n1-n2.<br><br>n1 and n2 must be of the same length.                                                                                                                                                                                                                 |
| P                  | The position is to be checked for a displayable character (U, L, N or S).                                                                                                                                                                                                                                                      |
| S                  | The position is to be checked for special characters. See also <i>Support of Different Character Sets with NATCONV.INI</i> in the <i>Operations</i> documentation.                                                                                                                                                             |
| U                  | The position is to be checked for an upper-case alphabetical character (A - Z).                                                                                                                                                                                                                                                |
| X                  | The position is to be checked against the equivalent position in the value ( <i>operand2</i> ) following the mask-definition.<br><br>X is not allowed in a variable mask definition, as it makes no sense.                                                                                                                     |
| YY                 | The two positions are to be checked for a valid year (00 - 99). See also <a href="#">Checking Dates</a> .                                                                                                                                                                                                                      |
| YYYY               | The four positions are checked for a valid year (0000 - 2699).                                                                                                                                                                                                                                                                 |



| Character | Meaning                                                                                                                                                                                                                                                                                                                                                                                                                                                                                                                                                                                                                          |
|-----------|----------------------------------------------------------------------------------------------------------------------------------------------------------------------------------------------------------------------------------------------------------------------------------------------------------------------------------------------------------------------------------------------------------------------------------------------------------------------------------------------------------------------------------------------------------------------------------------------------------------------------------|
| Z         | <p>The position is to be checked for a character whose left half-byte is hexadecimally 3 or 7, and whose right half-byte is hexadecimally 0 - 9.</p> <p>This may be used to correctly check for numeric digits in negative numbers. With N (which indicates a position to be checked for a numeric digit), a check for numeric digits in negative numbers leads to incorrect results, because the sign of the number is stored in the last digit of the number, causing that digit to be hexadecimally represented as non-numeric.</p> <p>Within a mask, use only one Z for each sequence of numeric digits that is checked.</p> |

## Mask Length

The length of the mask determines how many positions are to be checked.

### Example:

```

DEFINE DATA LOCAL
1 #CODE (A15)
END-DEFINE
...
IF #CODE = MASK (NN'ABC'...NN)
...

```

In the above example, the first two positions of #CODE are to be checked for numeric content. The three following positions are checked for the contents ABC. The next four positions are not to be checked. Positions ten and eleven are to be checked for numeric content. Positions twelve to fifteen are not to be checked.

## Checking Dates

Only one date may be checked within a given mask. When the same date component (JJJ, DD, MM, YY or YYYY) is specified more than once in the mask, only the value of the last occurrence is checked for consistency with other date components.

When dates are checked for a day (DD) and no month (MM) is specified in the mask, the current month will be assumed.

When dates are checked for a day (DD) or a Julian day (JJJ) and no year (YY or YYYY) is specified in the mask, the current year will be assumed.

When dates are checked for a 2-digit year (YY), the current century will be assumed if no Sliding or Fixed Window is set. For more details about Sliding or Fixed Windows, refer to profile parameter YSLW in the *Parameter Reference*.

**Example 1:**

```
MOVE 1131 TO #DATE (N4)
IF #DATE = MASK (MMDD)
```

In this example, month and day are checked for validity. The value for month (11) will be considered valid, whereas the value for day (31) will be invalid since the 11th month has only 30 days.

**Example 2:**

```
IF #DATE(A8) = MASK (MM'/'DD'/'YY)
```

In this example, the content of the field #DATE is checked for a valid date with the format MM/DD/YY (month/day/year).

**Example 3:**

```
IF #DATE (A8) = MASK (1950-2020MMDD)
```

In this example, the content of field #DATE is checked for a four-digit number in the range 1950 to 2020 followed by a valid month and day in the current year.



**Note:** Although apparent, the above mask does not allow to check for a valid date in the years 1950 through 2020, because the numeric value range 1950-2020 is checked independent of the validation of month and day. The check will deliver the intended results except for February, 29, where the result depends on whether the current year is a leap year or not. To check for a specific year range in addition to the date validation, code one check for the date validation and another for the range validation:

```
IF #DATE (A8) = MASK (YYYYMMDD) AND #DATE = MASK (1950-2020)
```

**Example 4:**

```
IF #DATE (A4) = MASK (19-20YY)
```

In this example, the content of field #DATE is checked for a two-digit number in the range 19 to 20 followed by a valid two-digit year (00 through 99). The century is supplied by Natural as described above.



**Note:** Although apparent, the above mask does not allow to check for a valid year in the range 1900 through 2099, because the numeric value range 19-20 is checked independent of the year validation. To check for year ranges, code one check for the date validation and another for the range validation:

```
IF #DATE (A10) = MASK (YYYY'-'MM'-'DD) AND #DATE = MASK (19-20)
```

### Checking Against the Content of Constants or Variables

If the value for the mask check is to be taken from either a constant or a variable, this value (*operand2*) must be specified immediately following the *mask-definition*.

*operand2* must be at least as long as the mask.

In the mask, you indicate each position to be checked with an X, and each position not to be checked with a period (.) or a question mark (?) or an underscore (\_).

#### Example:

```
DEFINE DATA LOCAL
1 #NAME (A15)
END-DEFINE
...
IF #NAME = MASK (..XX) 'ABCD'
...
```

In the above example, it is checked whether the field #NAME contains CD in the third and fourth positions. Positions one and two are not checked.

The length of the mask determines how many positions are to be checked. The mask is left-justified against any field or constant used in the mask operation. The format of the field (or constant) on the right side of the expression must be the same as the format of the field on the left side of the expression.

If the field to be checked (*operand1*) is of format A, any constant used (*operand2*) must be enclosed in apostrophes. If the field is numeric, the value used must be a numeric constant or the content of a numeric database field or user-defined variable.

In either case, any characters/digits within the value specified whose positions do not match the X indicator within the mask are ignored.

The result of the MASK operation is true when the indicated positions in both values are identical.

#### Example:

```
** Example 'LOGICX01': MASK option in logical condition
*****
DEFINE DATA LOCAL
1 EMPLOY-VIEW VIEW OF EMPLOYEES
  2 CITY
END-DEFINE
*
HISTOGRAM EMPLOY-VIEW CITY
  IF CITY =
```

```
MASK (....XX) '....NN'
```

```
    DISPLAY NOTITLE CITY *NUMBER
END-IF
END-HISTOGRAM
*
END
```

In the above example, the record will be accepted if the fifth and sixth positions of the field CITY each contain the character N.

## Range Checks

When performing range checks, the number of positions verified in the supplied variable is defined by the precision of the value supplied in the mask specification. For example, a mask of (...193...) will verify positions 4 to 6 for a three-digit number in the range 000 to 193.

Additional Examples of Mask Definitions:

- In this example, each character of #NAME is checked for an alphabetical character:

```
IF #NAME (A10) = MASK (AAAAAAAAAA)
```

- In this example, positions 4 to 6 of #NUMBER are checked for a numeric value:

```
IF #NUMBER (A6) = MASK (...NNN)
```

- In this example, positions 4 to 6 of #VALUE are to be checked for the value 123:

```
IF #VALUE(A10) = MASK (...'123')
```

- This example will check if #LICENSE contains a license number which begins with NY - and whose last five characters are identical to the last five positions of #VALUE:

```
DEFINE DATA LOCAL
1 #VALUE(A8)
1 #LICENSE(A8)
END-DEFINE
INPUT 'ENTER KNOWN POSITIONS OF LICENSE PLATE:' #VALUE
IF #LICENSE = MASK ('NY-XXXXX) #VALUE
```

- The following condition would be met by any value which contains NAT and AL no matter which and how many other characters are between NAT and AL (this would include the values NATURAL and NATIONALITY as well as NATAL):

```
MASK('NAT'*'AL')
```

## Checking Packed or Unpacked Numeric Data

Legacy applications often have packed or unpacked numeric variables redefined with alphanumeric or binary fields. Such redefinitions are not recommended, because using the packed or unpacked variable in an assignment or computation may lead to errors or unpredictable results. To validate the contents of such a redefined variable before the variable is used, use the N option (see *Characters in a Mask*) as many as number of digits - 1 times followed by a single Z option.

### Examples :

```
IF #P1 (P1) = MASK (Z)
IF #N4 (N4) = MASK (NNNZ)
IF #P5 (P5) = MASK (NNNNZ)
```

For further information about checking field contents, see *MASK Option Compared with IS Option*.

## MASK Option Compared with IS Option

This section points out the difference between MASK option and IS option and contains a sample program to illustrate the difference.

The IS option can be used to check whether the content of an alphanumeric or Unicode field can be converted to a specific other format, but it cannot be used to check if the value of an alphanumeric field is in the specified format.

The MASK option can be used to validate the contents of a redefined packed or unpacked numeric variable.

### Example Illustrating the Difference:

```
** Example 'LOGICX09': MASK versus IS option in logical condition
*****
DEFINE DATA LOCAL
1 #A2 (A2)
1 REDEFINE #A2
2 #N2 (N2)
1 REDEFINE #A2
2 #P3 (P3)
1 #CONV-N2 (N2)
1 #CONV-P3 (P3)
END-DEFINE
*
#A2 := '12'
WRITE NOTITLE 'Assignment #A2 := "12" results in:'
```

```

PERFORM SUBTEST
#A2 := '-1'
WRITE NOTITLE / 'Assignment #A2 := "-1" results in:'
PERFORM SUBTEST
#N2 := 12
WRITE NOTITLE / 'Assignment #N2 := 12 results in:'
PERFORM SUBTEST
#N2 := -1
WRITE NOTITLE / 'Assignment #N2 := -1 results in:'
PERFORM SUBTEST
#P3 := 12
WRITE NOTITLE / 'Assignment #P3 := 12 results in:'
PERFORM SUBTEST
#P3 := -1
WRITE NOTITLE / 'Assignment #P3 := -1 results in:'
PERFORM SUBTEST
*

DEFINE SUBROUTINE SUBTEST
IF #A2 IS (N2) THEN
  #CONV-N2 := VAL(#A2)
  WRITE NOTITLE 12T '#A2 can be converted to' #CONV-N2 '(N2)'
END-IF
IF #A2 IS (P3) THEN
  #CONV-P3 := VAL(#A2)
  WRITE NOTITLE 12T '#A2 can be converted to' #CONV-P3 '(P3)'
END-IF
IF #N2 = MASK(NZ) THEN
  WRITE NOTITLE 12T '#N2 contains the valid unpacked number' #N2
END-IF
IF #P3 = MASK(NNZ) THEN
  WRITE NOTITLE 12T '#P3 contains the valid packed number' #P3
END-IF
END-SUBROUTINE
*
END

```

**Output of Program LOGICX09:**

```

Assignment #A2 := '12' results in:
  #A2 can be converted to 12 (N2)
  #A2 can be converted to 12 (P3)
  #N2 contains the valid unpacked number 12

Assignment #A2 := '-1' results in:
  #A2 can be converted to -1 (N2)
  #A2 can be converted to -1 (P3)

Assignment #N2 := 12 results in:
  #A2 can be converted to 12 (N2)
  #A2 can be converted to 12 (P3)
  #N2 contains the valid unpacked number 12

```

```
Assignment #N2 := -1 results in:
    #N2 contains the valid unpacked number -1

Assignment #P3 := 12 results in:
    #P3 contains the valid packed number 12

Assignment #P3 := -1 results in:
    #P3 contains the valid packed number -1
```

## MODIFIED Option - Check whether Field Content has been Modified

Syntax:

```
operand1 [NOT] MODIFIED
```

This option is used to determine whether the content of a field has been modified during the execution of an INPUT or PROCESS PAGE statement. As a precondition, a control variable must have been assigned using the parameter CV.

Operand Definition Table:

| Operand         | Possible Structure | Possible Formats | Referencing Permitted | Dynamic Definition |
|-----------------|--------------------|------------------|-----------------------|--------------------|
| <i>operand1</i> | S A                | C                | no                    | no                 |

Attribute control variables referenced in an INPUT or PROCESS PAGE statement are always assigned the status “not modified” when the map is transmitted to the terminal.

Whenever the content of a field referencing an attribute control variable is modified, the attribute control variable has been assigned the status “modified”. When multiple fields reference the same attribute control variable, the variable is marked “modified” if any of these fields is modified.

If *operand1* is an array, the result will be true if at least one of the array elements has been assigned the status “modified” (OR operation).

### Example of MODIFIED Option:

```
** Example 'LOGICX06': MODIFIED option in logical condition
*****
DEFINE DATA LOCAL
1 #ATTR (C)
1 #A (A1)
1 #B (A1)
END-DEFINE
*
MOVE (AD=I) TO #ATTR
```

```

*
INPUT (CV=#ATTR) #A #B
IF #ATTR NOT MODIFIED
  WRITE NOTITLE 'FIELD #A OR #B HAS NOT BEEN MODIFIED'
END-IF
*
IF #ATTR MODIFIED
  WRITE NOTITLE 'FIELD #A OR #B HAS BEEN MODIFIED'
END-IF
*
END
    
```

Output of Program LOGICX06:

#A #B

After entering any value and pressing ENTER, the following output is displayed:

FIELD #A OR #B HAS BEEN MODIFIED

## SCAN Option - Scan for a Value within a Field

---

Syntax:

$$operand1 \left\{ \begin{array}{l} = \\ EQ \\ EQUAL TO \\ NE \\ NOT EQUAL \end{array} \right\} SCAN \left\{ \begin{array}{l} operand2 \\ (operand2) \end{array} \right\}$$

Operand Definition Table:

| Operand         | Possible Structure | Possible Formats | Referencing Permitted | Dynamic Definition |
|-----------------|--------------------|------------------|-----------------------|--------------------|
| <i>operand1</i> | C S A N            | A U N P          | yes                   | no                 |
| <i>operand2</i> | C S                | A U B*           | yes                   | no                 |

\* *operand2* may only be binary if *operand1* is of format A or U. If *operand1* is of format U and *operand2* is of format B, then the length of *operand2* must be even.

The SCAN option is used to scan for a specific value within a field.



The characters used in the `SCAN` option (*operand2*) may be specified as an alphanumeric or Unicode constant (a character string bounded by apostrophes) or the contents of an alphanumeric or Unicode database field or user-defined variable.

 **Caution:** Trailing blanks are automatically eliminated from *operand1* and *operand2*. Therefore, the `SCAN` option cannot be used to scan for values containing trailing blanks. *operand1* and *operand2* may contain leading or embedded blanks. If *operand2* consists of blanks only, scanning will be assumed to be successful, regardless of the value of *operand1*; confer `EXAMINE FULL` statement if trailing blanks are not to be ignored in the scan operation.

The field to be scanned (*operand1*) may be of format A, N, P or U. The `SCAN` operation may be specified with the equal (EQ) or not equal (NE) operators.

The length of the character string for the `SCAN` operation should be less than the length of the field to be scanned. If the length of the character string specified is identical to the length of the field to be scanned, then an `EQUAL` operator should be used instead of `SCAN`.

### Example of SCAN Option:

```
** Example 'LOGICX02': SCAN option in logical condition
*****
DEFINE DATA
LOCAL
1 EMPLOY-VIEW VIEW OF EMPLOYEES
  2 NAME
*
1 #VALUE   (A4)
1 #COMMENT (A10)
END-DEFINE
*
INPUT 'ENTER SCAN VALUE:' #VALUE
LIMIT 15
*
HISTOGRAM EMPLOY-VIEW FOR NAME
  RESET #COMMENT
  IF NAME = SCAN #VALUE
    MOVE 'MATCH' TO #COMMENT
  END-IF
  DISPLAY NOTITLE NAME *NUMBER #COMMENT
END-HISTOGRAM
*
END
```

Output of Program LOGICX02:

ENTER SCAN VALUE: ↵

A scan for example for LL delivers three matches in 15 names:

| NAME       | NMBR | #COMMENT |
|------------|------|----------|
| ABELLAN    |      | 1 MATCH  |
| ACHIESON   | 1    |          |
| ADAM       | 1    |          |
| ADKINSON   | 8    |          |
| AECKERLE   | 1    |          |
| AFANASSIEV | 2    |          |
| AHL        | 1    |          |
| AKROYD     | 1    |          |
| ALEMAN     | 1    |          |
| ALESTIA    | 1    |          |
| ALEXANDER  | 5    |          |
| ALLEGRE    | 1    | MATCH    |
| ALLSOP     | 1    | MATCH    |
| ALTINOK    | 1    |          |
| ALVAREZ    | 1    |          |

## SPECIFIED Option - Check whether a Value is Passed for an Optional Parameter

---

Syntax:

```
parameter-name [NOT] SPECIFIED
```

This option is used to check whether an optional parameter in an invoked object (subprogram, external subroutine or ActiveX control) has received a value from the invoking object or not.

An optional parameter is a field defined with the keyword `OPTIONAL` in the `DEFINE DATA PARAMETER` statement of the invoked object. If a field is defined as `OPTIONAL`, a value can - but need not - be passed from an invoking object to this field.

In the invoking statement, the notation `nX` is used to indicate parameters for which no values are passed.

If you process an optional parameter which has not received a value, this will cause a runtime error. To avoid such an error, you use the `SPECIFIED` option in the invoked object to check whether an optional parameter has received a value or not, and then only process it if it has.

*parameter-name* is the name of the parameter as specified in the `DEFINE DATA PARAMETER` statement of the invoked object.

For a field not defined as OPTIONAL, the SPECIFIED condition is always TRUE.

### Example of SPECIFIED Option:

#### Calling Programming:

```
** Example 'LOGICX07': SPECIFIED option in logical condition
*****
DEFINE DATA LOCAL
1 #PARM1 (A3)
1 #PARM3 (N2)
END-DEFINE
*
#PARM1 := 'ABC'
#PARM3 := 20
*
CALLNAT 'LOGICX08' #PARM1 1X #PARM3
*
END ↵
```

#### Subprogram Called:

```
** Example 'LOGICX08': SPECIFIED option in logical condition
*****
DEFINE DATA PARAMETER
1 #PARM1 (A3)
1 #PARM2 (N2) OPTIONAL
1 #PARM3 (N2) OPTIONAL
END-DEFINE
*
WRITE '=' #PARM1
*
IF #PARM2 SPECIFIED
  WRITE '#PARM2 is specified'
  WRITE '=' #PARM2
ELSE
  WRITE '#PARM2 is not specified'
* WRITE '=' #PARM2 /* would cause runtime error NAT1322
END-IF
*
IF #PARM3 NOT SPECIFIED
  WRITE '#PARM3 is not specified'
ELSE
  WRITE '#PARM3 is specified'
  WRITE '=' #PARM3
END-IF
END ↵
```

#### Output of Program LOGICX07:

Page 1

04-12-15 11:25:41

```
#PARM1: ABC  
#PARM2 is not specified  
#PARM3 is specified  
#PARM3: 20
```

# 47 Rules for Arithmetic Assignment

---

|                                                                 |     |
|-----------------------------------------------------------------|-----|
| ▪ Field Initialization .....                                    | 456 |
| ▪ Data Transfer .....                                           | 456 |
| ▪ Field Truncation and Field Rounding .....                     | 459 |
| ▪ Result Format and Length in Arithmetic Operations .....       | 459 |
| ▪ Arithmetic Operations with Floating-Point Numbers .....       | 460 |
| ▪ Arithmetic Operations with Date and Time .....                | 462 |
| ▪ Performance Considerations for Mixed Format Expressions ..... | 466 |
| ▪ Precision of Results of Arithmetic Operations .....           | 466 |
| ▪ Error Conditions in Arithmetic Operations .....               | 467 |
| ▪ Processing of Arrays .....                                    | 468 |

## Field Initialization

A field (user-defined variable or database field) which is to be used as an operand in an arithmetic operation must be defined with one of the following formats:

| Format |                  |
|--------|------------------|
| N      | Numeric unpacked |
| P      | Packed numeric   |
| I      | Integer          |
| F      | Floating point   |
| D      | Date             |
| T      | Time             |



**Note:** For reporting mode: A field which is to be used as an operand in an arithmetic operation must have been previously defined. A user-defined variable or database field used as a result field in an arithmetic operation need not have been previously defined.

All user-defined variables and all database fields defined in a `DEFINE DATA` statement are initialized to the appropriate zero or blank value when the program is invoked for execution.

## Data Transfer

Data transfer is performed with a `MOVE` or `COMPUTE` statement. The following table summarizes the data transfer compatibility of the formats an operand may take.

| Sending Field Format | Receiving Field Format |        |        |               |               |   |   |   |   |   |   |   |   |
|----------------------|------------------------|--------|--------|---------------|---------------|---|---|---|---|---|---|---|---|
|                      | N or P                 | A      | U      | $B_n (n < 5)$ | $B_n (n > 4)$ | I | L | C | D | T | F | G | O |
| N or P               | Y                      | [ 2 ]  | [ 14 ] | [ 3 ]         | -             | Y | - | - | - | Y | Y | - | - |
| A                    | -                      | Y      | [ 13 ] | [ 1 ]         | [ 1 ]         | - | - | - | - | - | - | - | - |
| U                    | -                      | [ 11 ] | Y      | [ 12 ]        | [ 12 ]        | - | - | - | - | - | - | - | - |
| $B_n (n < 5)$        | [ 4 ]                  | [ 2 ]  | [ 14 ] | [ 5 ]         | [ 5 ]         | Y | - | - | - | Y | Y | - | - |
| $B_n (n > 4)$        | -                      | [ 6 ]  | [ 15 ] | [ 5 ]         | [ 5 ]         | - | - | - | - | - | - | - | - |
| I                    | Y                      | [ 2 ]  | [ 14 ] | [ 3 ]         | -             | Y | - | - | - | Y | Y | - | - |
| L                    | -                      | [ 9 ]  | [ 16 ] | -             | -             | - | Y | - | - | - | - | - | - |
| C                    | -                      | -      | -      | -             | -             | - | - | Y | - | - | - | - | - |

|          |   |       |        |        |        |       |   |   |       |       |   |   |   |   |   |
|----------|---|-------|--------|--------|--------|-------|---|---|-------|-------|---|---|---|---|---|
| <b>D</b> | Y | [ 9 ] | [ 16 ] | Y      | -      | Y     | - | - | Y     | [ 7 ] | Y | - | - |   |   |
| <b>T</b> | Y | [ 9 ] | [ 16 ] | Y      | -      | Y     | - | - | [ 8 ] | Y     | Y | - | - |   |   |
| <b>F</b> | Y | [ 9 ] | [ 10 ] | [ 10 ] | [ 16 ] | [ 3 ] | - | Y | -     | -     | - | Y | Y | - | - |
| <b>G</b> | - | -     | -      | -      | -      | -     | - | - | -     | -     | - | - | Y | - |   |
| <b>O</b> | - | -     | -      | -      | -      | -     | - | - | -     | -     | - | - | - | Y |   |

Where:

|            |                                                                                        |
|------------|----------------------------------------------------------------------------------------|
| <b>Y</b>   | Indicates data transfer compatibility.                                                 |
| <b>-</b>   | Indicates data transfer incompatibility.                                               |
| <b>[ ]</b> | Numbers in brackets [ ] refer to the corresponding rule for data transfer given below. |

### Data Conversion

The following rules apply to converting data values:

**1. Alphanumeric to binary:**

The value will be moved byte by byte from left to right. The result may be truncated or padded with trailing blank characters depending on the length defined and the number of bytes specified.

**2. (N,P,I) and binary (length 1-4) to alphanumeric:**

The value will be converted to unpacked form and moved into the alphanumeric field left justified, that is, leading zeros will be suppressed and the field will be filled with trailing blank characters. For negative numeric values, the sign will be converted to the hexadecimal notation D<sub>x</sub>. Any decimal point in the numeric value will be ignored. All digits before and after the decimal point will be treated as one integer value.

**3. (N,P,I,F) to binary (1-4 bytes):**

The numeric value will be converted to binary (4 bytes). Any decimal point in the numeric value will be ignored (the digits of the value before and after the decimal point will be treated as an integer value). The resulting binary number will be positive or a two's complement of the number depending on the sign of the value.

**4. Binary (1-4 bytes) to numeric:**

The value will be converted and assigned to the numeric value right justified, that is, with leading zeros. (Binary values of the length 1-3 bytes are always assumed to have a positive sign. For binary values of 4 bytes, the leftmost bit determines the sign of the number: 1=negative, 0=positive.) Any decimal point in the receiving numeric value will be ignored. All digits before and after the decimal point will be treated as one integer value.

**5. Binary to binary:**

The value will be moved from right to left byte by byte. Leading binary zeros will be inserted into the receiving field.

**6. Binary (>4 bytes) to alphanumeric:**

The value will be moved byte by byte from left to right. The result may be truncated or padded with trailing blanks depending on the length defined and the number of bytes specified.

**7. Date (D) to time (T):**

If date is moved to time, it is converted to time assuming time 00:00:00:0.

**8. Time (T) to date (D):**

If time is moved to date, the time information is truncated, leaving only the date information.

**9. L,D,T,F to A:**

The values are converted to display form and are assigned left justified.

**10. F:**

If F is assigned to an alphanumeric or Unicode field which is too short, the mantissa is reduced accordingly.

**11. Unicode to alphanumeric:**

The Unicode value will be converted to alphanumeric character codes according to the default code page (value of the system variable \*CODEPAGE) using the International Components for Unicode (ICU) library. The result may be truncated or padded with trailing blank characters, depending on the length defined and the number of bytes specified.

**12. Unicode to binary:**

The value will be moved code unit by code unit from left to right. The result may be truncated or padded with trailing blank characters, depending on the length defined and the number of bytes specified. The length of the receiving binary field must be even.

**13. Alphanumeric to Unicode:**

The alphanumeric value will be converted from the default code page to a Unicode value using the International Components for Unicode (ICU) library. The result may be truncated or padded with trailing blank characters, depending on the length defined and the number of code units specified.

**14. (N,P,I) and binary (length 1-4) to Unicode:**

The value will be converted to unpacked form from which an alphanumeric value will be obtained by suppression of leading zeros. For negative numeric values, the sign will be converted to the hexadecimal notation D<sub>x</sub>. Any decimal point in the numeric value will be ignored. All digits before and after the decimal point will be treated as one integer value. The resulting value will be converted from alphanumeric to Unicode. The result may be truncated or padded with trailing blank characters, depending on the length defined and the number of code units specified.

**15. Binary (>4 bytes) to Unicode:**

The value will be moved byte by byte from left to right. The result may be truncated or padded with trailing blanks, depending on the length defined and the number of bytes specified. The length of the sending binary field must be even.



**16. L,D,T,F to U:**

The values are converted to an alphanumeric display form. The resulting value will be converted from alphanumeric to Unicode and assigned left justified.

If source and target format are identical, the result may be truncated or padded with trailing blank characters (format A and U) or leading binary zeros (format B) depending on the length defined and the number of bytes (format A and B) or code units (format U) specified.

See also *Using Dynamic Variables*.

## Field Truncation and Field Rounding

The following rules apply to field truncation and rounding:

- High-order numeric field truncation is allowed only when the digits to be truncated are leading zeros. Digits following an expressed or implied decimal point may be truncated.
- Trailing positions of an alphanumeric field may be truncated.
- If the option `ROUNDED` is specified, the last position of the result will be rounded up if the first truncated decimal position of the value being assigned contains a value greater than or equal to 5. For the result precision of a division, see also *Precision of Results of Arithmetic Operations*.

## Result Format and Length in Arithmetic Operations

The following table shows the format and length of the result of an arithmetic operation:

|        | I1 | I2 | I4 | N or P | F4 | F8 |
|--------|----|----|----|--------|----|----|
| I1     | I1 | I2 | I4 | P*     | F4 | F8 |
| I2     | I2 | I2 | I4 | P*     | F4 | F8 |
| I4     | I4 | I4 | I4 | P*     | F4 | F8 |
| N or P | P* | P* | P* | P*     | F4 | F8 |
| F4     | F4 | F4 | F4 | F4     | F4 | F8 |
| F8     | F8 | F8 | F8 | F8     | F8 | F8 |

On a mainframe computer, format/length F8 is used instead of F4 for improved precision of the results of an arithmetic operation.

P\* is determined from the integer length and precision of the operands individually for each operation, as shown under *Precision of Results of Arithmetic Operations*.

The following decimal integer lengths and possible values are applicable for format I:

| Format/Length | Decimal Integer Length | Possible Values           |
|---------------|------------------------|---------------------------|
| I1            | 3                      | -128 to 127               |
| I2            | 5                      | -32768 to 32767           |
| I4            | 10                     | -2147483648 to 2147483647 |

## Arithmetic Operations with Floating-Point Numbers

---

The following topics are covered below:

- [General Considerations](#)
- [Precision of Floating-Point Numbers](#)
- [Conversion to Floating-Point Representation](#)
- [Platform Dependency](#)

### General Considerations

Floating-point numbers (format F) are represented as a sum of powers of two (as are integer numbers (format I)), whereas unpacked and packed numbers (formats N and P) are represented as a sum of powers of ten.

In unpacked or packed numbers, the position of the decimal point is fixed. In floating-point numbers, however, the position of the decimal point (as the name indicates) is “floating”, that is, its position is not fixed, but depends on the actual value.

Floating-point numbers are essential for the computing of trigonometric functions or mathematical functions such as sinus or logarithm.

### Precision of Floating-Point Numbers

Due to the nature of floating-point numbers, their precision is limited:

- For a variable of format/length F4, the precision is limited to approximately 7 digits.
- For a variable of format/length F8, the precision is limited to approximately 15 digits.

Values which have more significant digits cannot be represented exactly as a floating-point number. No matter how many additional digits there are before or after the decimal point, a floating-point number can cover only the leading 7 or 15 digits respectively.

An integer value can only be represented exactly in a variable of format/length F4 if its absolute value does not exceed  $2^{23} - 1$ .

## Conversion to Floating-Point Representation

When an alphanumeric, unpacked numeric or packed numeric value is converted to floating-point format (for example, in an assignment operation), the representation has to be changed, that is, a sum of powers of ten has to be converted to a sum of powers of two.

Consequently, only numbers that are representable as a finite sum of powers of two can be represented exactly; all other numbers can only be represented approximately.

### Examples:

This number has an exact floating-point representation:

$$1.25 = 2^0 + 2^{-2}$$

This number is a periodic floating-point number without an exact representation:

$$1.2 = 2^0 + 2^{-3} + 2^{-4} + 2^{-7} + 2^{-8} + 2^{-11} + 2^{-12} + \dots$$

Thus, the conversion of alphanumeric, unpacked numeric or packed numeric values to floating-point values, and vice versa, can introduce small errors.

## Platform Dependency

Because of different hardware architecture, the representation of floating-point numbers varies according to platforms. This explains why the same application, when run on different platforms, may return slightly different results when floating-point arithmetics are involved. The respective representation also determines the range of possible values for floating-point variables, which is (approximately)

- $\pm 1.17 * 10^{-38}$  to  $\pm 3.40 * 10^{38}$  for F4 variables,
- $\pm 2.22 * 10^{-308}$  to  $\pm 1.79 * 10^{308}$  for F8 variables.



**Note:** The representation used by your pocket calculator may also be different from the one used by your computer - which explains why results for the same computation may differ.

## Arithmetic Operations with Date and Time

With formats D (date) and T (time), only addition, subtraction, multiplication and division are allowed. Multiplication and division are allowed on intermediate results of additions and subtractions only.

Date/time values can be added to/subtracted from one another; or integer values (no decimal digits) can be added to/subtracted from date/time values. Such integer values can be contained in fields of formats N, P, I, D, or T.

The intermediate results of such an addition or subtraction may be used as a multiplicand or dividend in a subsequent operation.

An integer value added to/subtracted from a date value is assumed to be in days. An integer value added to/subtracted from a time value is assumed to be in tenths of seconds.

For arithmetic operations with date and time, certain restrictions apply, which are due to the Natural's internal handling of arithmetic operations with date and time, as explained below.

Internally, Natural handles an arithmetic operation with date/time variables as follows:

```
COMPUTE result-field = operand1 +/- operand2
```

The above statement is resolved as:

1. *intermediate-result* = *operand1* +/- *operand2*
2. *result-field* = *intermediate-result*

That is, in a first step Natural computes the result of the addition/subtraction, and in a second step assigns this result to the result field.

More complex arithmetic operations are resolved following the same pattern:

```
COMPUTE result-field = operand1 +/- operand2 +/- operand3 +/- operand4
```

The above statement is resolved as:

1. *intermediate-result1* = *operand1* +/- *operand2*
2. *intermediate-result2* = *intermediate-result1* +/- *operand3*
3. *intermediate-result3* = *intermediate-result2* +/- *operand4*
4. *result-field* = *intermediate-result3*

The resolution of multiplication and division operations is similar to the resolution for addition and subtraction.

The internal format of such an intermediate result depends on the formats of the operands, as shown in the tables below.

### Addition

The following table shows the format of the intermediate result of an addition ( $intermediate\text{-}result = operand1 + operand2$ ):

| Format of <i>operand1</i> | Format of <i>operand2</i> | Format of <i>intermediate-result</i> |
|---------------------------|---------------------------|--------------------------------------|
| D                         | D                         | Di                                   |
| D                         | T                         | T                                    |
| D                         | Di, Ti, N, P, I           | D                                    |
| T                         | D, T, Di, Ti, N, P, I     | T                                    |
| Di, Ti, N, P, I           | D                         | D                                    |
| Di, Ti, N, P, I           | T                         | T                                    |
| Di, N, P, I               | Di                        | Di                                   |
| Ti, N, P, I               | Ti                        | Ti                                   |
| Di                        | Ti, N, P, I               | Di                                   |
| Ti                        | Di, N, P, I               | Ti                                   |

### Subtraction

The following table shows the format of the intermediate result of a subtraction ( $intermediate\text{-}result = operand1 - operand2$ ):

| Format of <i>operand1</i> | Format of <i>operand2</i> | Format of <i>intermediate-result</i> |
|---------------------------|---------------------------|--------------------------------------|
| D                         | D                         | Di                                   |
| D                         | T                         | Ti                                   |
| D                         | Di, Ti, N, P, I           | D                                    |
| T                         | D, T                      | Ti                                   |
| T                         | Di, Ti, N, P, I           | T                                    |
| Di, N, P, I               | D                         | Di                                   |
| Di, N, P, I               | T                         | Ti                                   |
| Di                        | Di, Ti, N, P, I           | Di                                   |
| Ti                        | D, T, Di, Ti, N, P, I     | Ti                                   |
| N, P, I                   | Di, Ti                    | P12                                  |

### Multiplication or Division

The following table shows the format of the intermediate result of a multiplication ( $intermediate\text{-}result = operand1 * operand2$ ) or division ( $intermediate\text{-}result = operand1 / operand2$ ):

| Format of <i>operand1</i> | Format of <i>operand2</i> | Format of <i>intermediate-result</i> |
|---------------------------|---------------------------|--------------------------------------|
| D                         | D, Di, Ti, N, P, I        | Di                                   |
| D                         | T                         | Ti                                   |
| T                         | D, T, Di, Ti, N, P, I     | Ti                                   |
| Di                        | T                         | Ti                                   |
| Di                        | D, Di, Ti, N, P, I        | Di                                   |
| Ti                        | D                         | Di                                   |
| Ti                        | Di, T, Ti, N, P, I        | Ti                                   |
| N, P, I                   | D, Di                     | Di                                   |
| N, P, I                   | T, Ti                     | Ti                                   |

### Internal Assignments

Di is a value in internal date format; Ti is a value in internal time format; such values can be used in further arithmetic date/time operations, but they cannot be assigned to a result field of format D (see the assignment table below).

In complex arithmetic operations in which an intermediate result of internal format Di or Ti is used as operand in a further addition/subtraction/multiplication/division, its format is assumed to be D or T respectively.

The following table shows which intermediate results can internally be assigned to which result fields ( $result\text{-}field = intermediate\text{-}result$ ).

| Format of <i>result-field</i> | Format of <i>intermediate-result</i> | Assignment possible |
|-------------------------------|--------------------------------------|---------------------|
| D                             | D, T                                 | yes                 |
| D                             | Di, Ti, N, P, I                      | no                  |
| T                             | D, T, Di, Ti, N, P, I                | yes                 |
| N, P, I                       | D, T, Di, Ti, N, P, I                | yes                 |

A result field of format D or T must not contain a negative value.

**Examples 1 and 2 (invalid):**

```
COMPUTE DATE1 (D) = DATE2 (D) + DATE3 (D)
COMPUTE DATE1 (D) = DATE2 (D) - DATE3 (D)
```

These operations are not possible, because the intermediate result of the addition/subtraction would be format  $D_i$ , and a value of format  $D_i$  cannot be assigned to a result field of format  $D$ .

**Examples 3 and 4 (invalid):**

```
COMPUTE DATE1 (D) = TIME2 (T) - TIME3 (T)
COMPUTE DATE1 (D) = DATE2 (D) - TIME3 (T)
```

These operations are not possible, because the intermediate result of the addition/subtraction would be format  $T_i$ , and a value of format  $T_i$  cannot be assigned to a result field of format  $D$ .

**Example 5 (valid):**

```
COMPUTE DATE1 (D) = DATE2 (D) - DATE3 (D) + TIME3 (T)
```

This operation is possible. First,  $DATE3$  is subtracted from  $DATE2$ , giving an intermediate result of format  $D_i$ ; then, this intermediate result is added to  $TIME3$ , giving an intermediate result of format  $T$ ; finally, this second intermediate result is assigned to the result field  $DATE1$ .

**Examples 6 and 7 (invalid):**

```
COMPUTE DATE1 (D) = DATE2 (D) + DATE3 (D) * 2
COMPUTE TIME1 (T) = TIME2 (T) - TIME3 (T) / 3
```

These operations are not possible, because the attempted multiplication/division is performed with date/time fields and not with intermediate results.

**Example 8 (valid):**

```
COMPUTE DATE1 (D) = DATE2 (D) + (DATE3(D) - DATE4 (D)) * 2
```

This operation is possible. First,  $DATE4$  is subtracted from  $DATE3$  giving an intermediate result of format  $D_i$ ; then, this intermediate result is multiplied by two giving an intermediate result of format  $D_i$ ; this intermediate result is added to  $DATE2$  giving an intermediate result of format  $D$ ; finally, this third intermediate result is assigned to the result field  $DATE1$ .

If a format  $T$  value is assigned to a format  $D$  field, you must ensure that the time value contains a valid date component.

## Performance Considerations for Mixed Format Expressions

When doing arithmetic operations, the choice of field formats has considerable impact on performance:

For business arithmetic, only fields of format I (integer) should be used, if possible.

For scientific arithmetic, fields of format F (floating point) should be used, if possible.

In expressions where formats are mixed between numeric (N, P) and floating point (F), a conversion to floating point format is performed. This conversion results in considerable CPU load. Therefore it is recommended to avoid mixed format expressions in arithmetic operations.

## Precision of Results of Arithmetic Operations

| Operation            | Digits Before Decimal Point                   | Digits After Decimal Point            |
|----------------------|-----------------------------------------------|---------------------------------------|
| Addition/Subtraction | $F_i + 1$ or $S_i + 1$ (whichever is greater) | $F_d$ or $S_d$ (whichever is greater) |
| Multiplication       | $F_i + S_i + 2$                               | $F_d + S_d$ (maximum 7)               |
| Division             | $F_i + S_d$                                   | (see below)                           |
| Exponentiation       | $15 - F_d$ (See <i>Exception</i> below)       | $F_d$                                 |
| Square Root          | $F_i$                                         | $F_d$                                 |

- where:

|          |                             |
|----------|-----------------------------|
| <b>F</b> | First operand               |
| <b>S</b> | Second operand              |
| <b>R</b> | Result                      |
| <b>i</b> | Digits before decimal point |
| <b>d</b> | Digits after decimal point  |

### Exception:

If the exponent has one or more digits after the decimal point, the exponentiation is internally carried out in floating point format and the result will also have floating point format. See *Arithmetic Operations with Floating-Point Numbers* for further information.



## Digits after Decimal Point for Division Results

The precision of the result of a division depends whether a result field is available or not:

- If a result field is available, the precision is: Fd or Rd (whichever is greater) <sup>\*</sup>.
- If no result field is available, the precision is: Fd or Sd (whichever is greater) <sup>\*</sup>.

<sup>\*</sup> If the `ROUNDED` option is used, the precision of the result is internally increased by one digit before the result is actually rounded.

A result field is available (or assumed to be available) in a `COMPUTE` and `DIVIDE` statement, and in a logical condition in which the division is placed after the comparison operator (for example: `IF #A = #B / #C THEN ...`).

A result field is not (or assumed to be not) available in a logical condition in which the division is placed before the comparison operator (for example: `IF #B / #C = #A THEN ...`).

### Exception:

If both dividend and divisor are of integer format and at least one of them is a variable, the division result is always of integer format (regardless of the precision of the result field and of whether the `ROUNDED` option is used or not).

## Precision of Results for Arithmetic Expressions

The precision of arithmetic expressions, for example: `#A / (#B * #C) + #D * (#E - #F + #G)`, is derived by evaluating the results of the arithmetic operations in their processing order. For further information on arithmetic expressions, see *arithmetic-expression* in the `COMPUTE` statement description.

## Error Conditions in Arithmetic Operations

In an addition, subtraction, multiplication or division, an error occurs if the total number of digits (before and after the decimal point) of the result is greater than 31.

In an exponentiation, an error occurs in any of the following situations:

- if the base is of packed format and either the result has over 16 digits or any intermediate result has over 15 digits;
- if the base is of floating-point format and the result is greater than approximately  $7 * 10^{75}$ .

## Processing of Arrays

Generally, the following rules apply:

- All scalar operations may be applied to array elements which consist of a single occurrence.
- If a variable is defined with a constant value (for example, #FIELD (I2) CONSTANT <8>), the value will be assigned to the variable at compilation, and the variable will be treated as a constant. This means that if such a variable is used in an array index, the dimension concerned has a *definite* number of occurrences.
- If an assignment/comparison operation involves two arrays with a different number of dimensions, the “missing” dimension in the array with fewer dimensions is assumed to be (1:1).

Example: If #ARRAY1 (1:2) is assigned to #ARRAY2 (1:2,1:2), #ARRAY1 is assumed to be #ARRAY1 (1:1,1:2).

The following topics are covered below:

- [Definitions of Array Dimensions](#)
- [Assignment Operations with Arrays](#)
- [Comparison Operations with Arrays](#)
- [Arithmetic Operations with Arrays](#)

### Definitions of Array Dimensions

The first, second and third dimensions of an array are defined as follows:

| Number of Dimensions | Properties                        |
|----------------------|-----------------------------------|
| 3                    | #a3(3rd dim., 2nd dim., 1st dim.) |
| 2                    | #a2(2nd dim., 1st dim.)           |
| 1                    | #a1(1st dim.)                     |

### Assignment Operations with Arrays

If an array range is assigned to another array range, the assignment is performed element by element.

Example:

```

DEFINE DATA LOCAL
1 #ARRAY(I4/1:5) INIT <10,20,30,40,50>
END-DEFINE
*
MOVE #ARRAY(2:4) TO #ARRAY(3:5)
/* is identical to
/* MOVE #ARRAY(2) TO #ARRAY(3)
/* MOVE #ARRAY(3) TO #ARRAY(4)
/* MOVE #ARRAY(4) TO #ARRAY(5)
/*
/* #ARRAY contains 10,20,20,20,20

```

If a single occurrence is assigned to an array range, each element of the range is filled with the value of the single occurrence. (For a mathematical function, each element of the range is filled with the result of the function.)

Before an assignment operation is executed, the individual dimensions of the arrays involved are compared with one another to check if they meet one of the conditions listed below. The dimensions are compared independently of one another; that is, the 1st dimension of the one array is compared with the 1st dimension of the other array, the 2nd dimension of the one array is compared with the 2nd dimension of the other array, and the 3rd dimension of the one array is compared with the 3rd dimension of the other array.

The assignment of values from one array to another is only allowed under one of the following conditions:

- The number of occurrences is the same for both dimensions compared.
- The number of occurrences is indefinite for both dimensions compared.
- The dimension that is assigned to another dimension consists of a single occurrence.

#### Example - Array Assignments:

The following program shows which array assignment operations are possible.

```

DEFINE DATA LOCAL
1 A1 (N1/1:8)
1 B1 (N1/1:8)
1 A2 (N1/1:8,1:8)
1 B2 (N1/1:8,1:8)
1 A3 (N1/1:8,1:8,1:8)
1 I (I2) INIT <4>
1 J (I2) INIT <8>
1 K (I2) CONST <8>
END-DEFINE
*
COMPUTE A1(1:3) = B1(6:8) /* allowed
COMPUTE A1(1:I) = B1(1:I) /* allowed
COMPUTE A1(*) = B1(1:8) /* allowed
COMPUTE A1(2:3) = B1(I:I+1) /* allowed

```

```

COMPUTE A1(1) = B1(I) /* allowed
COMPUTE A1(1:I) = B1(3) /* allowed
COMPUTE A1(I:J) = B1(I+2) /* allowed
COMPUTE A1(1:I) = B1(5:J) /* allowed
COMPUTE A1(1:I) = B1(2) /* allowed
COMPUTE A1(1:2) = B1(1:J) /* NOT ALLOWED ←
(NAT0631)
COMPUTE A1(*) = B1(1:J) /* NOT ALLOWED ←
(NAT0631)
COMPUTE A1(*) = B1(1:K) /* allowed
COMPUTE A1(1:J) = B1(1:K) /* NOT ALLOWED ←
(NAT0631)
*
COMPUTE A1(*) = B2(1,*) /* allowed
COMPUTE A1(1:3) = B2(1,I:I+2) /* allowed
COMPUTE A1(1:3) = B2(1:3,1) /* NOT ALLOWED ←
(NAT0631)
*
COMPUTE A2(1,1:3) = B1(6:8) /* allowed
COMPUTE A2(*,1:I) = B1(5:J) /* allowed
COMPUTE A2(*,1) = B1(*) /* NOT ALLOWED ←
(NAT0631)
COMPUTE A2(1:I,1) = B1(1:J) /* NOT ALLOWED ←
(NAT0631)
COMPUTE A2(1:I,1:J) = B1(1:J) /* allowed
*
COMPUTE A2(1,I) = B2(1,1) /* allowed
COMPUTE A2(1:I,1) = B2(1:I,2) /* allowed
COMPUTE A2(1:2,1:8) = B2(I:I+1,*) /* allowed
*
COMPUTE A3(1,1,1:I) = B1(1) /* allowed
COMPUTE A3(1,1,1:J) = B1(*) /* NOT ALLOWED ←
(NAT0631)
COMPUTE A3(1,1,1:I) = B1(1:I) /* allowed
COMPUTE A3(1,1:2,1:I) = B2(1,1:I) /* allowed
COMPUTE A3(1,1,1:I) = B2(1:2,1:I) /* NOT ALLOWED ←
(NAT0631)
END

```

## Comparison Operations with Arrays

Generally, the following applies: if arrays with multiple dimensions are compared, the individual dimensions are handled independently of one another; that is, the 1st dimension of the one array is compared with the 1st dimension of the other array, the 2nd dimension of the one array is compared with the 2nd dimension of the other array, and the 3rd dimension of the one array is compared with the 3rd dimension of the other array.

The comparison of two array dimensions is only allowed under one of the following conditions:

- The array dimensions compared with one another have the same number of occurrences.

- The array dimensions compared with one another have an indefinite number of occurrences.
- All array dimensions of one of the arrays involved are single occurrences.

### Example - Array Comparisons:

The following program shows which array comparison operations are possible:

```

DEFINE DATA LOCAL
1 A3 (N1/1:8,1:8,1:8)
1 A2 (N1/1:8,1:8)

1 A1 (N1/1:8)
1 I (I2) INIT <4>
1 J (I2) INIT <8>
1 K (I2) CONST <8>
END-DEFINE
*
IF A2(1,1) = A1(1) THEN IGNORE END-IF /* allowed
IF A2(1,1) = A1(I) THEN IGNORE END-IF /* allowed
IF A2(1,*) = A1(1) THEN IGNORE END-IF /* allowed
IF A2(1,*) = A1(I) THEN IGNORE END-IF /* allowed
IF A2(1,*) = A1(*) THEN IGNORE END-IF /* allowed
IF A2(1,*) = A1(I -3:I+4) THEN IGNORE END-IF /* allowed
IF A2(1,5:J) = A1(1:I) THEN IGNORE END-IF /* allowed
IF A2(1,*) = A1(1:I) THEN IGNORE END-IF /* NOT ALLOWED(NAT0629)
IF A2(1,*) = A1(1:K) THEN IGNORE END-IF /* allowed
*
IF A2(1,1) = A2(1,1) THEN IGNORE END-IF /* allowed
IF A2(1,1) = A2(1,I) THEN IGNORE END-IF /* allowed
IF A2(1,*) = A2(1,1:8) THEN IGNORE END-IF /* allowed
IF A2(1,*) = A2(I,I -3:I+4) THEN IGNORE END-IF /* allowed
IF A2(1,1:I) = A2(1,I+1:J) THEN IGNORE END-IF /* allowed
IF A2(1,1:I) = A2(1,I:I+1) THEN IGNORE END-IF /* NOT ALLOWED(NAT0629)
IF A2(*,1) = A2(1,*) THEN IGNORE END-IF /* NOT ALLOWED(NAT0629)
IF A2(1,1:I) = A1(2,1:K) THEN IGNORE END-IF /* NOT ALLOWED(NAT0629)
*
IF A3(1,1,*) = A2(1,*) THEN IGNORE END-IF /* allowed
IF A3(1,1,*) = A2(1,I -3:I+4) THEN IGNORE END-IF /* allowed
IF A3(1,*,I:J) = A2(*,1:I+1) THEN IGNORE END-IF /* allowed
IF A3(1,*,I:J) = A2(*,I:J) THEN IGNORE END-IF /* allowed
END

```

When you compare two array ranges, note that the following two expressions lead to different results:

```
#ARRAY1(*) NOT EQUAL #ARRAY2(*)  
NOT #ARRAY1(*) = #ARRAY2(*)
```

Example:

### ■ Condition A:

```
IF #ARRAY1(1:2) NOT EQUAL #ARRAY2(1:2)
```

This is equivalent to:

```
IF (#ARRAY1(1) NOT EQUAL #ARRAY2(1)) AND (#ARRAY1(2) NOT EQUAL #ARRAY2(2))
```

Condition A is therefore true if the first occurrence of #ARRAY1 does not equal the first occurrence of #ARRAY2 *and* the second occurrence of #ARRAY1 does not equal the second occurrence of #ARRAY2.

### ■ Condition B:

```
IF NOT #ARRAY1(1:2) = #ARRAY2(1:2)
```

This is equivalent to:

```
IF NOT (#ARRAY1(1)= #ARRAY2(1) AND #ARRAY1(2) = #ARRAY2(2))
```

This in turn is equivalent to:

```
IF (#ARRAY1(1) NOT EQUAL #ARRAY2(1)) OR (#ARRAY1(2) NOT EQUAL #ARRAY2(2))
```

Condition B is therefore true if *either* the first occurrence of #ARRAY1 does not equal the first occurrence of #ARRAY2 *or* the second occurrence of #ARRAY1 does not equal the second occurrence of #ARRAY2.

## Arithmetic Operations with Arrays

A general rule about arithmetic operations with arrays is that the number of occurrences of the corresponding dimensions must be equal.

The following illustrates this rule:

```
#c(2:3,2:4) := #a(3:4,1:3) + #b(3:5)
```

In other words:

| Array | Dimension Number | Number of Occurrences | Range |
|-------|------------------|-----------------------|-------|
| #c    | 2nd              | 2                     | 2:3   |
| #c    | 1st              | 3                     | 2:4   |
| #a    | 2nd              | 2                     | 3:4   |
| #a    | 1st              | 3                     | 1:3   |
| #b    | 1st              | 3                     | 3:5   |

The operation is performed element by element.



**Note:** An arithmetic operation of a different number of dimensions is allowed.

For the example above, the following operations are executed:

```
#c(2,2) := #a(3,1) + #b(3)
#c(2,3) := #a(3,2) + #b(4)
#c(2,4) := #a(3,3) + #b(5)
#c(3,2) := #a(4,1) + #b(3)
#c(3,3) := #a(4,2) + #b(4)
#c(3,4) := #a(4,3) + #b(5)
```

Below is a list of examples of how array ranges may be used in the following ways in arithmetic operations (in COMPUTE, ADD or MULTIPLY statements). In examples 1-4, the number of occurrences of the corresponding dimensions must be equal.

1.  $range + range = range$ .

The addition is performed element by element.

2.  $range * range = range$ .

The multiplication is performed element by element.

3.  $scalar + range = range$ .

The scalar is added to each element of the range.

4.  $range * scalar = range$ .

Each element of the range is multiplied by the scalar.

5.  $range + scalar = scalar$ .

Each element of the range is added to the scalar and the result is assigned to the scalar.

6.  $scalar * range = scalar2$ .

The scalar is multiplied by each element of the array and the result is assigned to *scalar2*.

Since intermediate results will be generated for arithmetic operations as shown in the above examples, the result of overlapping index ranges is computed element by element in an intermediate result array and finally the intermediate result array is assigned to the result field.

Example:

```
DEFINE DATA LOCAL
1 #ARRAY(I4/1:5) INIT <10,20,30,40,50>
END-DEFINE

#ARRAY(3:5) := #ARRAY(2:4) + 1

/* A temporary array for the
/* intermediate result values is
/* generated implicitly: #temp(1:3).
/* The following operations are
/* performed internally:
/* #temp(1) := #ARRAY(2) + 1
/* #temp(2) := #ARRAY(3) + 1
/* #temp(3) := #ARRAY(4) + 1
/* #ARRAY(3:5) := #temp(1:3)
/*
/* #ARRAY contains 10,20,21,31,41
```



# 48 Invoking Natural Subprograms from 3GL Programs

---

- Passing Parameters from the 3GL Program to the Subprogram ..... 476
- Example of Invoking a Natural Subprogram from a 3GL Program ..... 477

Natural subprograms can be invoked from a programming object written in a 3rd generation programming language (3GL). The invoking program can be written in any programming language that supports a standard `CALL` interface.

For this purpose, Natural provides the interface `ncxr_callnat`. The 3GL program invokes this interface with a specification of the name of the desired subprogram.



**Note:** Natural must have been activated beforehand; that is, the invoking 3GL program must in turn have been invoked by a Natural object with a `CALL` statement.

The subprogram is executed as if it had been invoked from another Natural object with a `CALLNAT` statement.

When the processing of the subprogram stops (either with the `END` statement or with an `ESCAPE ROUTINE` statement), control is returned to the 3GL program.

## Passing Parameters from the 3GL Program to the Subprogram

---

Parameters can be passed from the invoking 3GL program to the Natural subprogram. For passing parameters, the same rules apply as for passing parameters with a `CALL` statement.

The 3GL program invokes the Natural interface `ncxr_callnat` with four parameters:

- The 1st parameter is the name of the Natural subprogram to be invoked.
- The 2nd parameter contains the number of parameters to be passed to the subprogram.
- The 3rd parameter contains the address of the table that contains the addresses of the parameters to be passed to the subprogram.
- The 4th parameter contains the address of the table that contains the format/length specifications of the parameters to be passed to the subprogram.

The sequence, format and length of the parameters in the invoking program must match exactly the sequence, format and length of the fields in the `DEFINE DATA PARAMETER` statement of the subprogram. The names of the fields in the invoking program and the invoked subprogram can be different.

## Example of Invoking a Natural Subprogram from a 3GL Program

---

For an example of how to invoke a Natural subprogram from a 3GL program, refer to the following samples in NATDIR:[*vnnnn.samples*] (where *nnnn* is the current version number).

- MY3GL.NSP (for the main program),
- MY3GLSUB.NSN (for the subprogram),
- MYC3GL.C (for the C function).



# 49 Issuing Operating System Commands from within a Natural Program

---

|                           |     |
|---------------------------|-----|
| ▪ Syntax .....            | 480 |
| ▪ Parameters .....        | 480 |
| ▪ Parameter Options ..... | 480 |
| ▪ Return Codes .....      | 481 |
| ▪ Examples .....          | 481 |

The Natural user exit SHCMD can be used to issue an operating system command, call a DCL command procedure or execute an executable program on OpenVMS from within a Natural program.

## Syntax

---

```
CALL 'SHCMD' 'command' [option']
```

## Parameters

---

|                |                                                                                                                                                                                                                                                                   |
|----------------|-------------------------------------------------------------------------------------------------------------------------------------------------------------------------------------------------------------------------------------------------------------------|
| <i>command</i> | <p>Command to be executed under control of the operating system command interpreter. Natural waits until the command is completed and then Natural returns control back to the Natural program.</p> <p>For more information, see <i>Examples</i> below.</p>       |
| <i>option</i>  | <p><i>option</i> describes how the command should be executed. This parameter is optional. The following options are available:</p> <ul style="list-style-type: none"> <li>■ SCREENIO</li> <li>■ NOSCREENIO</li> </ul> <p>See <i>Parameter Options</i> below.</p> |

## Parameter Options

---

The following parameter options are available:

| Option     | Description                                                                                                          |
|------------|----------------------------------------------------------------------------------------------------------------------|
| NOSCREENIO | This option is used to hide the output generated by the command. The hidden output is redirected to the null device. |
| SCREENIO   | This option is used to refresh the Natural screen output after the command is completed.                             |



**Note:** The options SCREENIO and NOSCREENIO may be not set at the same time.

## Return Codes

Natural manipulates return codes from the control interpreter in the following way:

- Even numbers are interpreted as error codes and are retained unchanged.
- Odd numbers are interpreted as success codes and are converted to 0.

The following return code values are available:

| Return Code     | Description                        |
|-----------------|------------------------------------|
| 0               | Command successfully executed.     |
| 4               | Illegal SHCMD parameter specified. |
| All other codes | Command has returned an error.     |

## Examples

Execute a DCL command procedure from within Natural:

```
CALL 'SHCMD' '@MYDCL.COM'
```

Execute an executable program from within Natural:

```
CALL 'SHCMD' 'MYPROGRAM.EXE'
```

After executing the `DIRECTORY` command, you will recognize that the output generated by this command has changed the last Natural screen output. You have to press the refresh-screen key to clear the screen. To do this automatically, you can specify the `SCREENIO` option:

```
CALL 'SHCMD' 'DIRECTORY' 'SCREENIO'
```

Retrieve the return code by using the `RET` function:

```
DEFINE DATA LOCAL
  1 rc (I4)
END-DEFINE
CALL 'SHCMD' '' 'SCREENIO'
ASSIGN rc = RET( 'SHCMD' )          /* retrieve return code
IF rc <> 0 THEN
  IF rc = 4 THEN
    WRITE NOTITLE 'Illegal option specified'
  ELSE
    WRITE NOTITLE 'Command not executed successfully (rc=' rc ')'
```

```
END-IF  
ELSE  
  WRITE NOTITLE 'Command executed successfully'  
END-IF  
END
```

Execute the DCL command procedure *MYSUCCESS.COM*. Natural will recognize that the command procedure returns an odd return number and assumes success by mapping the exit code 15 to 0.

DCL command procedure *MYSUCCESS.COM*:

```
$ WRITE SYS$OUTPUT "DCL returns SUCCESS"  
$ EXIT 15
```

Executing the DCL command procedure *MYERROR.COM*, Natural would recognize that the command procedure returns an even return number, assumes an error and leaves the number unchanged.

DCL command procedure *MYERROR.COM*:

```
$ WRITE SYS$OUTPUT "DCL returns ERROR"  
$ EXIT 14
```



# 50

## Statements for Internet and XML Access

---

|                              |     |
|------------------------------|-----|
| ▪ Statements Available ..... | 484 |
| ▪ Further References .....   | 485 |

This chapter gives an overview of the Natural statements for internet and XML access and contains a list of further references. To take full advantage of these statements, a thorough knowledge of the underlying communication standards is required.

## Statements Available

---

The following statements are available for internet and XML access:

- [REQUEST DOCUMENT](#)
- [PARSE XML](#)

### REQUEST DOCUMENT

This statement enables you to use the HTTP/HTTPS protocol.

The following is an example of how this statement can be used to access an externally-located document:

```
REQUEST DOCUMENT FROM
"http://bo1sap1:5555/invoke/sap.demo/handleRFC_XML_POST"
WITH
USER #User PASSWORD #Password
DATA
NAME 'XMLData' VALUE #Queryxml
NAME 'repServerName' VALUE 'NT2'
RETURN
PAGE #Resultxml
RESPONSE #rc ←
```

For further information, see `REQUEST DOCUMENT` in the *Statements* documentation.

### PARSE XML

The `PARSE XML` statement allows you to parse XML documents from a Natural program.

For further information, see `PARSE XML` in the *Statements* documentation.

## Further References

---

Below is a list of resources that you may find useful.

- [Sample Programs](#)
- [Training Courses](#)
- [Useful Links](#)

### Sample Programs

In addition to the sample programs provided at the end of the description of each statement, some sample programs are included in the Natural library SYSEXV.

### Training Courses

Software AG's Corporate University offers special training courses on this subject. See the Corporate University offerings on Empower at <https://empower.softwareag.com/>.

Or, ask your local Software AG representative for the availability of special on-site training courses at your location.

### Useful Links

Below is a collection of links that may be of interest.

- World Wide Web Consortium (W3C): <http://www.w3.org/>
- Extensible Markup Language (XML): <http://www.w3.org/XML/>
- HyperText Markup Language (HTML) Home Page: <http://www.w3.org/MarkUp/>
- W3 Schools: <http://www.w3schools.com/>



# VIII

## Portable Natural Generated Programs

---



# 51

## Portable Natural Generated Programs

---

- Compatibility ..... 490
- Endian Mode Considerations ..... 490
- ENDIAN Parameter ..... 491
- Portable FILEDIR.SAG and Error Message Files ..... 491

As of Natural Version 5, Natural generated programs (GPs) are portable across UNIX, OpenVMS and Windows platforms.

## Compatibility

---

As of Natural Version 5, a source which was cataloged on any Natural-supported UNIX, OpenVMS and Windows platform is executable with all of these Open Systems platforms without recompilation. This feature simplifies the deployment of applications across Open Systems platforms.

Natural applications generated with Natural Version 4 or Natural Version 3 can be executed with Natural Version 5 or above without cataloging the applications again (upward compatibility). In this case, the portable GP functionality is not available. To make use of the portable GP and other improvements, cataloging with Natural Version 5 or above is required.

Command processor GPs are not portable. The portable GP feature is not available for mainframe platforms. This means that Natural GPs which are generated on mainframe computers are not executable on UNIX, OpenVMS and Windows platforms without recompilation of the application and vice versa.

## Endian Mode Considerations

---

As of Natural Version 5, Natural acts as follows: Depending on which UNIX, OpenVMS or Windows platform it is running, Natural will consider the byte order in which multi-byte numbers are stored in the GP. The two byte order modes are called “Little Endian” and “Big Endian”.

- “Little Endian” means that the low-order byte of the number is stored in memory at the lowest address, and the high-order byte at the highest address (the little end comes first).
- “Big Endian” means that the high-order byte of the number is stored in memory at the lowest address, and the low-order byte at the highest address (the big end comes first).

The UNIX, OpenVMS and Windows platforms use both endian modes: Intel processors and AXP computers have “Little Endian” byte order, other processors such as HP-UX, Sun Solaris, or RS6000 use “Big Endian” mode.

Natural converts a portable GP automatically into the endian mode of the execution platform, if necessary. This endian conversion is not performed if the GP has been generated in the endian mode of the platform.



## ENDIAN Parameter

---

In order to increase execution performance of portable GPs, the profile parameter `ENDIAN` has been introduced. `ENDIAN` determines the endian mode in which a GP is generated during compilation:

|         |                                                              |
|---------|--------------------------------------------------------------|
| DEFAULT | The endian mode of the machine on which the GP is generated. |
| BIG     | Big endian mode (high order byte first).                     |
| LITTLE  | Little endian mode (low order byte first).                   |

The values `DEFAULT`, `BIG` and `LITTLE` are alternatives whereby the default value is `DEFAULT`.

The `ENDIAN` mode parameter may be set

- as a profile parameter,
- as a start-up parameter,
- as a session parameter.

## Portable FILEDIR.SAG and Error Message Files

---

As of Natural Version 6.2, the file `FILEDIR.SAG` and the error message files are platform independent. Hence, it is possible to share common `FUSER` system files among different Open Systems platforms. For example, it is possible to copy sets of Natural libraries from one Open Systems platform to another with operating system copy procedures. However, it is not recommended to share `FNAT` system files. For more information about the portable `FILEDIR.SAG`, refer to *Portable Natural System Files* in the *Operations* documentation.



# IX

## Designing Application User Interfaces

---

The user interface of an application, that is, the way an application presents itself to the user, is a key consideration when writing an application.

This part provides information on the various possibilities Natural offers for designing character-based user interfaces that are uniform in presentation and provide powerful mechanisms for user guidance and interaction.

When designing user interfaces, standards and standardization are key factors.

Using Natural, you can offer the end user common functionality across various hardware and operating systems.

This includes the general screen layout (information, data and message areas), function-key assignment and the layout of windows.

This part covers the following topics:

[Screen Design](#)

[Dialog Design](#)



# 52

## Screen Design

---

- Control of Function-Key Lines - Terminal Command %Y ..... 496
- Control of the Message Line - Terminal Command %M ..... 498
- Assigning Colors to Fields - Terminal Command %= ..... 498
- Infoline - Terminal Command %X ..... 499
- Windows ..... 500
- Standard/Dynamic Layout Maps ..... 509
- Multilingual User Interfaces ..... 509
- Skill-Sensitive User Interfaces ..... 513

## Control of Function-Key Lines - Terminal Command %Y

With the terminal command %Y you can define how and where the Natural function-key lines are to be displayed.

Below is information on:

- [Format of Function-Key Lines](#)
- [Positioning of Function-Key Lines](#)
- [Cursor-Sensitivity](#)

### Format of Function-Key Lines

The following terminal commands are available for defining the format of function-key lines:

#### %YN

The function-key lines are displayed in tabular Software AG format:

```
Command ==>
Enter-PF1---PF2---PF3---PF4---PF5---PF6---PF7---PF8---PF9---PF10--PF11--PF12---
      Help      Exit                                  Canc
```

#### %YS

The function-key lines display the keys sequentially and only show those keys to which names have been assigned (PF1=*value*, PF2=*value*, etc.):

```
Command ==>
PF1=Help,PF3=Exit,PF12=Canc
```

#### %YP

The function-key lines are displayed in PC-like format, that is, sequentially and only showing those keys to which names have been assigned (F1=*value*, F2=*value*, etc.):

```
Command ==>
F1=Help,F3=Exit,F12=Canc
```

## Other Display Options

Various other command options are available for function-key lines, such as:

- single- and double-line display,
- intensified display,
- reverse video display,
- color display.

For details on these options, see *%Y - Control of PF-Key Lines* in the *Terminal Commands* documentation.

## Positioning of Function-Key Lines

### **%YB**

The function-key lines are displayed at the bottom of the screen.

### **%YT**

The function-key lines are displayed at the top of the screen.

### **%Ynn**

The function-key lines are displayed on line *nn* of the screen.

## Cursor-Sensitivity

### **%YC**

This command makes the function-key lines cursor-sensitive. This means that they act like an action bar on a PC screen: you just move the cursor to the desired function-key number or name and press `Enter`, and `Natural` reacts as if the corresponding function key had been pressed.

To switch cursor-sensitivity off, you enter `%YC` again (toggle switch).

By using `%YC` in conjunction with tabular display format (`%YN`) and having only the function-key names displayed (`%YH`), you can equip your applications with very comfortable action bar processing: the user merely has to select a function name with the cursor and press `Enter`, and the function is executed.

## Control of the Message Line - Terminal Command %M

---

Various options of the terminal command %M are available for defining how and where the Natural message line is to be displayed.

Below is information on:

- [Positioning the Message Line](#)
- [Message Line Color](#)

### Positioning the Message Line

#### %MB

The message line is displayed at the bottom of the screen.

#### %MT

The message line is displayed at the top of the screen.

Other options for the positioning of the message line are described in *%M - Control of Message Line* in the *Terminal Commands* documentation.

### Message Line Color

#### %M=*color-code*

The message line is displayed in the specified color (for an explanation of color codes, see the session parameter CD as described in the *Parameter Reference*).

## Assigning Colors to Fields - Terminal Command %=

---

You can use the terminal command %= to assign colors to field attributes for programs that were originally not written for color support. The command causes all fields/text defined with the specified attributes to be displayed in the specified color.

If predefined color assignments are not suitable for your terminal type, you can use this command to override the original assignments with new ones.

You can also use the %= terminal command within Natural editors, for example to define color assignments dynamically during map creation.



| Codes        | Description                                                          |
|--------------|----------------------------------------------------------------------|
| <i>blank</i> | Clear color translate table.                                         |
| F            | Newly defined colors are to override colors assigned by the program. |
| N            | Color attributes assigned by program are not to be modified.         |
| O            | Output field.                                                        |
| M            | Modifiable field (output and input).                                 |
| T            | Text constant.                                                       |
| B            | Blinking                                                             |
| C            | Italic                                                               |
| D            | Default                                                              |
| I            | Intensified                                                          |
| U            | Underlined                                                           |
| V            | Reverse video                                                        |
| BG           | Background                                                           |
| BL           | Blue                                                                 |
| GR           | Green                                                                |
| NE           | Neutral                                                              |
| PI           | Pink                                                                 |
| RE           | Red                                                                  |
| TU           | Turquoise                                                            |
| YE           | Yellow                                                               |

Example:

```
%=TI=RE,OB=YE
```

This example assigns the color red to all intensified text fields and yellow to all blinking output fields.

## Infoline - Terminal Command %X

The terminal command %X controls the display of the Natural infoline.

For further information, see the description of the terminal command %X in the *Terminal Commands* documentation.

## Windows

---

Below is information on:

- [What is a Window?](#)
- [DEFINE WINDOW Statement](#)
- [INPUT WINDOW Statement](#)

### What is a Window?

A *window* is that segment of a logical page, built by a program, which is displayed on the terminal screen.

A *logical page* is the output area for Natural; in other words the logical page contains the current report/map produced by the Natural program for display. This logical page may be larger than the physical screen.

There is always a window present, although you may not be aware of its existence. Unless specified differently (by a `DEFINE WINDOW` statement), the size of the window is identical to the physical size of your terminal screen.

You can manipulate a window in two ways:

- You can control the size and position of the window on the *physical screen*.
- You can control the position of the window on the *logical page*.

### Positioning on the Physical Screen

The figure below illustrates the positioning of a window on the physical screen. Note that the same section of the logical page is displayed in both cases, only the position of the window on the screen has changed.

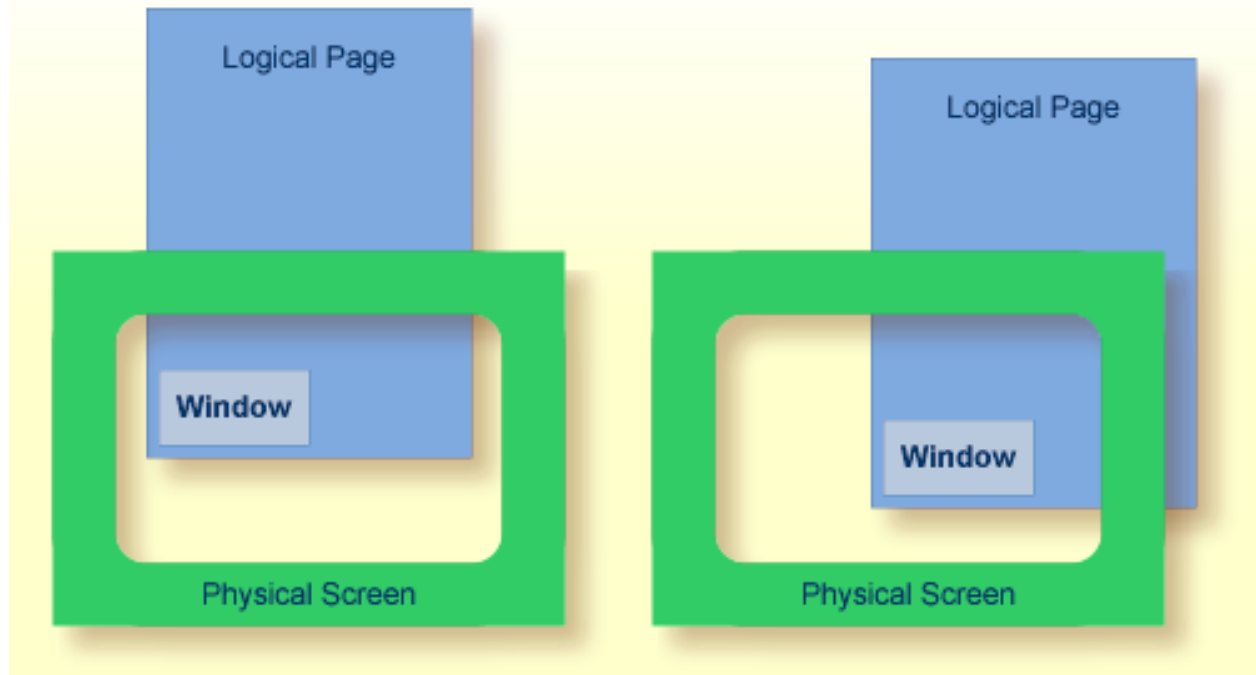

### Positioning on the Logical Page

The figure below illustrates the positioning of a window on the logical page.

When you change the position of the window on the *logical page*, the size and position of the window on the *physical screen* will remain unchanged. In other words, the window is not moved over the page, but the page is moved “underneath” the window.

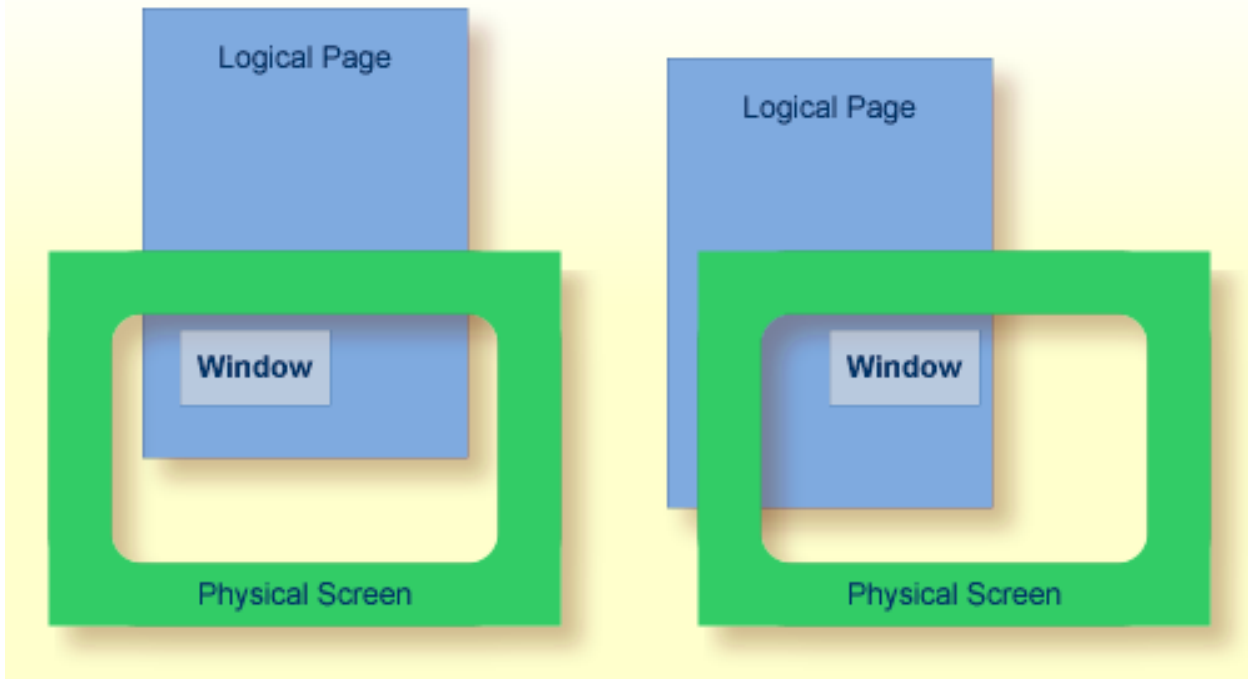

### DEFINE WINDOW Statement

You use the `DEFINE WINDOW` statement to specify the size, position and attributes of a window on the *physical screen*.

A `DEFINE WINDOW` statement does not activate a window; this is done with a `SET WINDOW` statement or with the `WINDOW` clause of an `INPUT` statement.

Various options are available with the `DEFINE WINDOW` statement. These are described below in the context of the following example.

The following program defines a window on the physical screen.

```

** Example 'WINDX01': DEFINE WINDOW
*****
DEFINE DATA LOCAL
1 COMMAND (A10)
END-DEFINE
*
DEFINE WINDOW TEST
    SIZE 5*25
    BASE 5/40
    TITLE 'Sample Window'
    CONTROL WINDOW
    FRAMED POSITION SYMBOL BOTTOM LEFT
    
```

```

*
INPUT WINDOW='TEST' WITH TEXT 'message line'
      COMMAND (AD=I'_' ) /
      'dataline 1' /
      'dataline 2' /
      'dataline 3' 'long data line'
*
IF COMMAND = 'TEST2'
  FETCH 'WINDX02'
ELSE
  IF COMMAND = '.'
    STOP
  ELSE
    REINPUT 'invalid command'
  END-IF
END-IF
END

```

The window-name identifies the window. The name may be up to 32 characters long. For a window name, the same naming conventions apply as for user-defined variables. Here the name is TEST.

The window size is set with the SIZE option. Here the window is 5 lines high and 25 columns (positions) wide.

The position of the window is set by the BASE option. Here the top left-hand corner of the window is positioned on line 5, column 40.

With the TITLE option, you can define a title that is to be displayed in the window frame (of course, only if you have defined a frame for the window).

With the CONTROL clause, you determine whether the PF-key lines, the message line and the statistics line are displayed in the window or on the full physical screen. Here CONTROL WINDOW causes the message line to be displayed inside the window. CONTROL SCREEN would cause the lines to be displayed on the full physical screen outside the window. If you omit the CONTROL clause, CONTROL WINDOW applies by default.

With the FRAMED option, you define that the window is to be framed. This frame is then cursor-sensitive. Where applicable, you can page forward, backward, left or right within the window by simply placing the cursor over the appropriate symbol (<, -, +, or >; see POSITION clause) and then pressing Enter. In other words, you are moving the *logical page* underneath the window on the physical screen. If no symbols are displayed, you can page backward and forward within the window by placing the cursor in the top frame line (for backward positioning) or bottom frame line (for forward positioning) and then pressing Enter.

With the POSITION clause of the FRAMED option, you define that information on the position of the window on the logical page is to be displayed in the frame of the window. This applies only if the logical page is larger than the window; if it is not, the POSITION clause will be ignored. The position information indicates in which directions the logical page extends above, below, to the left and to the right of the current window.

If the POSITION clause is omitted, POSITION SYMBOL TOP RIGHT applies by default.

POSITION SYMBOL causes the position information to be displayed in form of symbols: "More: < - + >". The information is displayed in the top and/or bottom frame line.

TOP/BOTTOM determines whether the position information is displayed in the top or bottom frame line.

LEFT/RIGHT determines whether the position information is displayed in the left or right part of the frame line.

You can define which characters are to be used for the frame with the terminal command %F=chv.

|          |                                                                                   |
|----------|-----------------------------------------------------------------------------------|
| <b>c</b> | The first character will be used for the four <i>corners</i> of the window frame. |
| <b>h</b> | The second character will be used for the <i>horizontal</i> frame lines.          |
| <b>v</b> | The third character will be used for the <i>vertical</i> frame lines.             |

Example:

```
%F=+- !
```

The above command makes the window frame look like this:

```
+-----+
!           !
!           !
!           !
!           !
+-----+
```

### INPUT WINDOW Statement

The INPUT WINDOW statement activates the window defined in the DEFINE WINDOW statement. In the example, the window TEST is activated. Note that if you wish to output data in a window (for example, with a WRITE statement), you use the SET WINDOW statement.

When the above program is run, the window is displayed with one input field COMMAND. The session parameter AD is used to define that the value of the field is displayed intensified and an underscore is used as filler character.

Output of Program WINDX01:

```

> r                                     > + Program WINDX01 Lib SYSEXP
Top  ....+....1....+....2....+....3....+....4....+....5....+....6....+....7..
0010 ** Example 'WINDX01': DEFINE WINDOW
0020 *****+-----Sample Window-----+ *****
0030 DEFINE DATA LOCAL                ! message line          !
0040 1 COMMAND (A10)                   ! COMMAND _____    !
0050 END-DEFINE                        ! dataline 1            !
0060 *                                 +More:      + >-----+
0070 DEFINE WINDOW TEST
0080     SIZE 5*25
0090     BASE 5/40
0100     TITLE 'Sample Window'
0110     CONTROL WINDOW
0120     FRAMED POSITION SYMBOL BOTTOM LEFT
0130 *
0140 INPUT WINDOW='TEST' WITH TEXT 'message line'
0150     COMMAND (AD=I'_' ) /
0160     'dataline 1' /
0170     'dataline 2' /
0180     'dataline 3' 'long data line'
0190 *
0200 IF COMMAND = 'TEST2'
      ....+....1....+....2....+....3....+....4....+....5....+... S 29 L 1

```

In the bottom frame line, the position information `More: + >` indicates that there is more information on the logical page than is displayed in the window.

To see the information that is further down on the logical page, you place the cursor in the bottom frame line on the plus (+) sign and press `Enter`.

The window is now moved downwards. Note that the text `long data line` does not fit in the window and is consequently not fully visible.

```

> r                                     > + Program      WINDX01  Lib SYSEXP
Top  ....+....1....+....2....+....3....+....4....+....5....+....6....+....7..
0010 ** Example 'WINDX01': DEFINE WINDOW
0020 *****+-----Sample Window-----+ *****
0030 DEFINE DATA LOCAL                ! message line      !
0040 1 COMMAND (A10)                   ! dataline 3 long data !
0050 END-DEFINE                        ! dataline 2        !
0060 *                                  +More:  -  >-----+
0070 DEFINE WINDOW TEST
0080     SIZE 5*25
0090     BASE 5/40
0100     TITLE 'Sample Window'
0110     CONTROL WINDOW
0120     FRAMED POSITION SYMBOL BOTTOM LEFT
0130 *
0140 INPUT WINDOW='TEST' WITH TEXT 'message line'
0150     COMMAND (AD=I'_' ) /
0160     'dataline 1' /
0170     'dataline 2' /
0180     'dataline 3' 'long data line'
0190 *
0200 IF COMMAND = 'TEST2'
      ....+....1....+....2....+....3....+....4....+....5....+... S 29  L 1

```

To see this hidden information to the right, you place the cursor in the bottom frame line on the less-than symbol (>) and press Enter. The window is now moved to the right on the logical page and displays the previously invisible word line:



```

> r                                     > + Program      WINDX01  Lib SYSEXPG
Top  ....+....1....+....2....+....3....+....4....+....5....+....6....+....7..
0010 ** Example 'WINDX01': DEFINE WINDOW
0020 *****+-----Sample Window-----+ *****
0030 DEFINE DATA LOCAL                ! message line      !
0040 1 COMMAND (A10)                   ! line                ! <==
0050 END-DEFINE                         !                      !
0060 *                                  +More: < -  -----+
0070 DEFINE WINDOW TEST
0080     SIZE 5*25
0090     BASE 5/40
0100     TITLE 'Sample Window'
0110     CONTROL WINDOW
0120     FRAMED POSITION SYMBOL BOTTOM LEFT
0130 *
0140 INPUT WINDOW='TEST' WITH TEXT 'message line'
0150     COMMAND (AD=I'_' ) /
0160     'dataline 1' /
0170     'dataline 2' /
0180     'dataline 3' 'long data line'
0190 *
0200 IF COMMAND = 'TEST2'
      ....+....1....+....2....+....3....+....4....+....5....+... S 29  L 1

```

## Multiple Windows

You can, of course, open multiple windows. However, only one Natural window is active at any one time, that is, the most recent window. Any previous windows may still be visible on the screen, but are no longer active and are ignored by Natural. You may enter input only in the most recent window. If there is not enough space to enter input, the window size must be adjusted first.

When TEST2 is entered in the COMMAND field, the program WINDX02 is executed.

```

** Example 'WINDX02': DEFINE WINDOW
*****
DEFINE DATA LOCAL
1 COMMAND (A10)
END-DEFINE
*
DEFINE WINDOW TEST2
  SIZE 5*30
  BASE 15/40
  TITLE 'Another Window'
  CONTROL SCREEN
  FRAMED POSITION SYMBOL BOTTOM LEFT
*
INPUT WINDOW='TEST2' WITH TEXT 'message line'
  COMMAND (AD=I'_' ) /
  'dataline 1' /

```

```

        'dataline 2' /
        'dataline 3' 'long data line'
*
IF COMMAND = 'TEST'
  FETCH 'WINDX01'
ELSE
  IF COMMAND = '.'
    STOP
  ELSE
    REINPUT 'invalid command'
  END-IF
END-IF
END

```

A second window is opened. The other window is still visible, but it is inactive.

```

message line
> r                                     > + Program      WINDX01  Lib SYSEXP
Top  ....+....1....+....2....+....3....+....4....+....5....+....6....+....7..
0010 ** Example 'WINDX01': DEFINE WINDOW
0020 *****+-----Sample Window-----+ *****
0030 DEFINE DATA LOCAL                ! message line      ! Inactive
0040 1 COMMAND (A10)                    ! COMMAND TEST2_____ ! Window
0050 END-DEFINE                          ! dataline 1        ! <==
0060 *                                  +More:      + >-----+
0070 DEFINE WINDOW TEST
0080     SIZE 5*25
0090     BASE 5/40
0100     TITLE 'Sample Window'
0110     CONTROL WINDOW
0120     FRAMED POSITION SYMBOL B +-----Another Window-----+ Currently ←
0130 *                                  ! COMMAND _____ ! Active
0140 INPUT WINDOW='TEST' WITH TEXT ' ! dataline 1          ! Window
0150     COMMAND (AD=I'_' ) /          ! dataline 2        ! <==
0160     'dataline 1' /                +More:      +-----+
0170     'dataline 2' /
0180     'dataline 3' 'long data line'
0190 *
0200 IF COMMAND = 'TEST2'

```

Note that for the new window the message line is now displayed on the full physical screen (at the top) and not in the window. This was defined by the `CONTROL SCREEN` clause in the `WINDX02` program.

For further details on the statements `DEFINE WINDOW`, `INPUT WINDOW` and `SET WINDOW`, see the corresponding descriptions in the *Statements* documentation.

## Standard/Dynamic Layout Maps

---

### Standard Layout Maps

A *standard layout* can be defined in the map editor. This layout guarantees a uniform appearance for all maps that reference it throughout the application.

When a map that references a standard layout is initialized, the standard layout becomes a fixed part of the map. This means that if this standard layout is modified, all affected maps must be re-cataloged before the changes take effect.

### Dynamic Layout Maps

In contrast to a standard layout, a *dynamic layout* does not become a fixed part of a map that references it, rather it is executed at runtime.

This means that if you define the layout map as “dynamic” on the Define Map Settings For MAP screen in the map editor, any modifications to the layout map are also carried out on all maps that reference it. The maps need not be re-cataloged.

For further details on layout maps, see *Map Editor* in the *Editors* documentation.

## Multilingual User Interfaces

---

Using Natural, you can create multilingual applications for international use.

Maps, help routines, error messages, programs, functions, subprograms and copycodes can be defined in up to 60 different languages (including languages with double-byte character sets).

Below is information on:

- [Language Codes](#)
- [Defining the Language of a Natural Object](#)
- [Defining the User Language](#)
- [Referencing Multilingual Objects](#)
- [Programs](#)

- [Edit Masks for Date and Time Fields](#)

## Language Codes

In Natural, each language has a *language code* (from 1 to 60). The table below is an extract from the full table of language codes. For a complete overview, refer to the description of the system variable \*LANGUAGE in the *System Variables* documentation.

| Language Code | Language   | Map Code in Object Names |
|---------------|------------|--------------------------|
| 1             | English    | 1                        |
| 2             | German     | 2                        |
| 3             | French     | 3                        |
| 4             | Spanish    | 4                        |
| 5             | Italian    | 5                        |
| 6             | Dutch      | 6                        |
| 7             | Turkish    | 7                        |
| 8             | Danish     | 8                        |
| 9             | Norwegian  | 9                        |
| 10            | Albanian   | A                        |
| 11            | Portuguese | B                        |

The language code (left column) is the code that is contained in the system variable \*LANGUAGE. This code is used by Natural internally. It is the code you use to define the user language (see [Defining the User Language](#) below). The code you use to identify the language of a Natural object is the *map code* in the right-hand column of the table.

Example:

The language code for Portuguese is "11". The code you use when cataloging a Portuguese Natural object is "B".

For the full table of language codes, see the system variable \*LANGUAGE as described in the *System Variables* documentation.

## Defining the Language of a Natural Object

To define the language of a Natural object (map, help routine, program, function, subprogram or copycode), you add the corresponding map code to the object name. Apart from the map code, the name of the object must be identical for all languages.

In the example below, a map has been created in English and in German. To identify the languages of the maps, the map code that corresponds to the respective language has been included in the map name.

### Example of Map Names for a Multilingual Application

DEM01 = English map (map code 1)

DEM02 = German map (map code 2)

### Defining Languages with Alphabetical Map Codes

Map codes are in the range 1-9, A-Z or a-y. The alphabetical map codes require special handling.

Normally, it is not possible to catalog an object with a lower-case letter in the name - all characters are automatically converted into capitals.

This is however necessary, if for example you wish to define an object for Kanji (Japanese) which has the language code 59 and the map code x.

To catalog such an object, you first set the correct language code (here 59) using the terminal command `%L=nn`, where `nn` is the language code.

You then catalog the object using the ampersand (&) character instead of the actual map code in the object name. So to have a Japanese version of the map DEMO, you store the map under the name DEMO&.

If you now look at the list of Natural objects, you will see that the map is correctly listed as DEMOx.

Objects with language codes 1-9 and upper case A-Z can be cataloged directly without the use of the ampersand (&) notation.

### Defining the User Language

You define the language to be used per user - as defined in the system variable `*LANGUAGE` - with the profile parameter `ULANG` (which is described in the *Parameter Reference*) or with the terminal command `%L=nn` (where `nn` is the language code).

## Referencing Multilingual Objects

To reference multilingual objects in a program, you use the ampersand (&) character in the name of the object.

The program below uses the maps DEMO1 and DEMO2. The ampersand (&) character at the end of the map name stands for the map code and indicates that the map with the current language as defined in the \*LANGUAGE system variable is to be used.

```
DEFINE DATA LOCAL
1 PERSONNEL VIEW OF EMPLOYEES
  2 NAME (A20)
  2 PERSONNEL-ID (A8)
1 CAR VIEW OF VEHICLES
  2 REG-NUM (A15)
1 #CODE (N1)
END-DEFINE
*
INPUT USING MAP 'DEMO&' /* <--- INVOKE MAP WITH CURRENT LANGUAGE CODE
...
```

When this program is run, the English map (DEMO1) is displayed. This is because the current value of \*LANGUAGE is 1 = English.

```
MAP DEMO1

SAMPLE MAP

Please select a function!

1.) Employee information
2.) Vehicle information

Enter code here: _
```

In the example below, the language code has been switched to 2 = German with the terminal command %L=2.

When the program is now run, the German map (DEMO2) is displayed.



## Programs

For some applications it may be useful to define multilingual programs. For example, a standard invoicing program, might use different subprograms to handle various tax aspects, depending on the country where the invoice is to be written.

Multilingual programs are defined with the same technique as described above for maps.

## Edit Masks for Date and Time Fields

The language used for date and time fields defined with edit masks also depends on the system variable `*LANGUAGE`.

For details on edit masks, see the session parameter `EM` as described in the *Parameter Reference*.

## Skill-Sensitive User Interfaces

---

Users with varying levels of skill may wish to have different maps (of varying detail) while using the same application.

If your application is not for international use by users speaking different languages, you can use the techniques for multilingual maps to define maps of varying detail.

For example, you could define language code 1 as corresponding to the skill of the beginner, and language code 2 as corresponding to the skill of the advanced user. This simple but effective technique is illustrated below.

The following map (PERS1) includes instructions for the end user on how to select a function from the menu. The information is very detailed. The name of the map contains the map code 1:

```
MAP PERS1

SAMPLE MAP

Please select a function

1.) Employee information _
2.) Vehicle information _

Enter code: _

To select a function, do one of the following:
- place the cursor on the input field next to desired function and press Enter
- mark the input field next to desired function with an X and press Enter
- enter the desired function code (1 or 2) in the 'Enter code' field and press
Enter
```

The same map, but without the detailed instructions is saved under the same name, but with map code 2.

```
MAP PERS2

SAMPLE MAP

Please select a function

1.) Employee information _
2.) Vehicle information _

Enter code: _
```

In the example above, the map with the detailed instructions is output, if the `ULANG` profile parameter has the value 1, the map without the instructions if the value is 2. See also the description of the profile parameter `ULANG` (in the *Parameter Reference*).



# 53

## Dialog Design

---

- Field-Sensitive Processing ..... 516
- Simplifying Programming ..... 518
- Line-Sensitive Processing ..... 519
- Column-Sensitive Processing ..... 520
- Processing Based on Function Keys ..... 520
- Processing Based on Function-Key Names ..... 521
- Processing Data Outside an Active Window ..... 522
- Copying Data from a Screen ..... 525
- Statements REINPUT/REINPUT FULL ..... 528

This chapter tells you how you can design character-based user interfaces that make user interaction with the application simple and flexible.

## Field-Sensitive Processing

---

### **\*CURS-FIELD and POS(field-name)**

Using the system variable `*CURS-FIELD` together with the system function `POS(field-name)`, you can define processing based on the field where the cursor is positioned at the time the user presses Enter.

`*CURS-FIELD` contains the internal identification of the field where the cursor is currently positioned; it cannot be used by itself, but only in conjunction with `POS(field-name)`.

You can use `*CURS-FIELD` and `POS(field-name)`, for example, to enable a user to select a function simply by placing the cursor on a specific field and pressing Enter.

The example below illustrates such an application:

```
DEFINE DATA LOCAL
1 #EMP (A1)
1 #CAR (A1)
1 #CODE (N1)
END-DEFINE
*
INPUT USING MAP 'CURS'
*
DECIDE FOR FIRST CONDITION
  WHEN *CURS-FIELD = POS(#EMP) OR #EMP = 'X' OR #CODE = 1
    FETCH 'LISTEMP'
  WHEN *CURS-FIELD = POS(#CAR) OR #CAR = 'X' OR #CODE = 2
    FETCH 'LISTCAR'
  WHEN NONE
    REINPUT 'PLEASE MAKE A VALID SELECTION'
END-DECIDE
END
```

And the result:

```

SAMPLE MAP

Please select a function

1.) Employee information  _
2.) Vehicle information  _ <== Cursor positioned
                           on field

Enter code:  _

To select a function, do one of the following:

- place the cursor on the input field next to desired function and press Enter
- mark the input field next to desired function with an X and press Enter
- enter the desired function code (1 or 2) in the 'Enter code' field and press
Enter

```

If the user places the cursor on the input field (#EMP) next to Employee information, and presses Enter, the program LISTEMP displays a list of employee names:

```

Page      1                               2001-01-22  09:39:32

      NAME
-----

ABELLAN
ACHIESON
ADAM
ADKINSON
ADKINSON
ADKINSON
ADKINSON
ADKINSON
ADKINSON
ADKINSON
ADKINSON
ADKINSON
ADKINSON
ADKINSON
AECKERLE
AFANASSIEV
AFANASSIEV
AHL
AKROYD

```



#### Notes:

1. In Natural for Ajax applications, \*CURS-FIELD identifies the operand that represents the value of the control that has the input focus. You may use \*CURS-FIELD in conjunction with the POS function to check for the control that has the input focus and perform processing depending on that condition.

2. The values of `*CURS-FIELD` and `POS(field-name)` serve for internal identification of the fields only. They cannot be used for arithmetical operations.

## Simplifying Programming

---

### System Function POS

The Natural system function `POS(field-name)` contains the internal identification of the field whose name is specified with the system function.

`POS(field-name)` may be used to identify a specific field, regardless of its position in a map. This means that the sequence and number of fields in a map may be changed, but `POS(field-name)` will still uniquely identify the same field. With this, for example, you need only a single `REINPUT` statement to make the field to be `MARKED` dependent on the program logic.



**Note:** The value `POS(field-name)` serves for internal identification of the fields only. It cannot be used for arithmetical operations.

Example:

```
...  
DECIDE ON FIRST VALUE OF ...  
  VALUE ...  
    COMPUTE #FIELDX = POS(FIELD1)  
  VALUE ...  
    COMPUTE #FIELDX = POS(FIELD2)  
  ...  
END-DECIDE  
...  
REINPUT ... MARK #FIELDX  
...
```

Full details on `*CURS-FIELD` and `POS(field-name)` are described in the *System Variables* and *System Functions* documentation.

## Line-Sensitive Processing

### System Variable \*CURS-LINE

Using the system variable \*CURS-LINE, you can make processing dependent on the line where the cursor is positioned at the time the user presses `Enter`.

Using this variable, you can make user-friendly menus. With the appropriate programming, the user merely has to place the cursor on the line of the desired menu option and press `Enter` to execute the option.

The cursor position is defined within the current active window, regardless of its physical placement on the screen.



**Note:** The message line, function-key lines and statistics line/infoline are not counted as data lines on the screen.

The example below demonstrates line-sensitive processing using the \*CURS-LINE system variable. When the user presses `Enter` on the map, the program checks if the cursor is positioned on line 8 of the screen which contains the option `Employee information`. If this is the case, the program that lists the names of employees `LISTEMP` is executed.

```

DEFINE DATA LOCAL
1 #EMP (A1)
1 #CAR (A1)
1 #CODE (N1)
END-DEFINE
*
INPUT USING MAP 'CURS'
*
DECIDE FOR FIRST CONDITION
  WHEN *CURS-LINE = 8
    FETCH 'LISTEMP'
  WHEN NONE
    REINPUT 'PLACE CURSOR ON LINE OF OPTION YOU WISH TO SELECT'
END-DECIDE
END

```

Output:

```
Company Information

Please select a function

[] 1.) Employee information
   2.) Vehicle information

Place the cursor on the line of the option you wish to select and press
Enter
```

The user places the cursor indicated by square brackets [] on the line of the desired option and presses `Enter` and the corresponding program is executed.

## Column-Sensitive Processing

---

### System Variable \*CURS-COL

The system variable `*CURS-COL` can be used in a similar way to `*CURS-LINE` described above. With `*CURS-COL` you can make processing dependent on the column where the cursor is positioned on the screen.

## Processing Based on Function Keys

---

### System Variable \*PF-KEY

Frequently you may wish to make processing dependent on the function key a user presses.

This is achieved with the statement `SET KEY`, the system variable `*PF-KEY` and a modification of the default map settings (`Standard Keys = Y`).

The `SET KEY` statement assigns functions to function keys during program execution. The system variable `*PF-KEY` contains the identification of the last function key the user pressed.

The example below illustrates the use of `SET KEY` in combination with `*PF-KEY`.

```

...
SET KEY PF1
*
INPUT USING MAP 'DEMO&'
IF *PF-KEY = 'PF1'
  WRITE 'Help is currently not active'
END-IF
...

```

The `SET KEY` statement activates PF1 as a function key.

The `IF` statement defines what action is to be taken when the user presses PF1. The system variable `*PF-KEY` is checked for its current content; if it contains PF1, the corresponding action is taken.

Further details regarding the statement `SET KEY` and the system variable `*PF-KEY` are described in the *Statements* and the *System Variables* documentation respectively.

## Processing Based on Function-Key Names

---

### System Variable `*PF-NAME`

When defining processing based on function keys, further comfort can be added by using the system variable `*PF-NAME`. With this variable you can make processing dependent on the name of a function, not on a specific key.

The variable `*PF-NAME` contains the name of the last function key the user pressed (that is, the name as assigned to the key with the `NAMED` clause of the `SET KEY` statement).

For example, if you wish to allow users to invoke help by pressing either PF3 or PF12, you assign the same name (in the example below: `INFO`) to both keys. When the user presses either one of the keys, the processing defined in the `IF` statement is performed.

```

...
SET KEY PF3  NAMED 'INFO'
          PF12 NAMED 'INFO'
INPUT USING MAP 'DEMO&'
IF *PF-NAME = 'INFO'
  WRITE 'Help is currently not active'
END-IF
...

```

The function names defined with `NAMED` appear in the function-key lines:

## Processing Data Outside an Active Window

---

Below is information on:

- [System Variable \\*COM](#)
- [Example Usage of \\*COM](#)
- [Positioning the Cursor to \\*COM - the %T\\* Terminal Command](#)

### System Variable \*COM

As stated in the section *Screen Design - [Windows](#)*, only *one* window is active at any one time. This normally means that input is only possible within that particular window.

Using the \*COM system variable, which can be regarded as a communication area, it is possible to enter data outside the current window.

The prerequisite is that a map contains \*COM as a modifiable field. This field is then available for the user to enter data when a window is currently on the screen. Further processing can then be made dependent on the content of \*COM.

This allows you to implement user interfaces as already used, for example, by Con-nect, Software AG's office system, where a user can always enter data in the command line, even when a window with its own input fields is active.

Note that \*COM is only cleared when the Natural session is ended.

### Example Usage of \*COM

In the example below, the program ADD performs a simple addition using the input data from a map. In this map, \*COM has been defined as a modifiable field (at the bottom of the map) with the length specified in the AL field of the Extended Field Editing. The result of the calculation is displayed in a window. Although this window offers no possibility for input, the user can still use the \*COM field in the map outside the window.

#### Program ADD:

```
DEFINE DATA LOCAL
1 #VALUE1 (N4)
1 #VALUE2 (N4)
1 #SUM3 (N8)
END-DEFINE
*
DEFINE WINDOW EMP
SIZE 8*17
BASE 10/2
```



```

TITLE 'Total of Add'
CONTROL SCREEN
FRAMED POSITION SYMBOL BOT LEFT
*
INPUT USING MAP 'WINDOW'
*
COMPUTE #SUM3 = #VALUE1 + #VALUE2
*
SET WINDOW 'EMP'
INPUT (AD=0) / 'Value 1 +' /
                'Value 2 =' //
                ' ' #SUM3
*
IF *COM = 'M'
    FETCH 'MULTIPLY' #VALUE1 #VALUE2
END-IF
END

```

### Output of Program ADD:

```

Map to Demonstrate Windows with *COM

CALCULATOR

Enter values you wish to calculate

Value 1: 12__
Value 2: 12__

+-Total of Add--+
!                 !
! Value 1 +      !
! Value 2 =      !
!                 !
!           24   !
!                 !
+-----+

Next line is input field (*COM) for input outside the window:

```

In this example, by entering the value M, the user initiates a multiplication function; the two values from the input map are multiplied and the result is displayed in a second window:

```

Map to Demonstrate Windows with *COM

                                CALCULATOR

                                Enter values you wish to calculate

                                Value 1: 12__
                                Value 2: 12__

+-Total of Add--+
!                   !
! Value 1 +       !
! Value 2 =       !
!                   !
!                24 !
!                   !
+-----+

                                +-----+
                                !         !
                                ! Value 1 x !
                                ! Value 2 = !
                                !         !
                                !        144 !
                                !         !
                                +-----+

Next line is input field (*COM) for input outside the window:
M

```

### Positioning the Cursor to \*COM - the %T\* Terminal Command

Normally, when a window is active and the window contains no input fields (AD=M or AD=A), the cursor is placed in the top left corner of the window.

With the terminal command %T\*, you can position the cursor to a \*COM system variable outside the window when the active window contains no input fields.

By using %T\* again, you can switch back to standard cursor placement.

Example:

```

...
INPUT USING MAP 'WINDOW'
*
COMPUTE #SUM3 = #VALUE1 + #VALUE2
*
SET CONTROL 'T*'
SET WINDOW 'EMP'
INPUT (AD=0) / 'Value 1 +' /
              'Value 2 =' //
              ' ' #SUM3
...

```

---

## Copying Data from a Screen

---

Below is information on:

- [Terminal Commands %CS and %CC](#)
- [Selecting a Line from Report Output for Further Processing](#)

### Terminal Commands %CS and %CC

With these terminal commands, you can copy parts of a screen into the Natural stack (%CS) or into the system variable \*COM (%CC). The protected data from a specific screen line are copied field by field.

The full options of these terminal commands are described in the *Terminal Commands* documentation.

Once copied to the stack or \*COM, the data are available for further processing. Using these commands, you can make user-friendly interfaces as in the example below.

### Selecting a Line from Report Output for Further Processing

In the following example, the program COM1 lists all employee names from Abellan to Alestia.

#### Program COM1:

```
DEFINE DATA LOCAL
1 EMP VIEW OF EMPLOYEES
  2 NAME(A20)
  2 MIDDLE-NAME (A20)
  2 PERSONNEL-ID (A8)
END-DEFINE
*
READ EMP BY NAME STARTING FROM 'ABELLAN' THRU 'ALESTIA'
  DISPLAY NAME
END-READ
FETCH 'COM2'
END
```

Output of Program COM1:

Page 1

2006-08-12 09:41:21

NAME  
-----

```
ABELLAN
ACHIESON
ADAM
ADKINSON
ADKINSON
ADKINSON
ADKINSON
ADKINSON
ADKINSON
ADKINSON
ADKINSON
ADKINSON
ADKINSON
AECKERLE
AFANASSIEV
AFANASSIEV
AHL
AKROYD
ALEMAN
ALESTIA
MORE
```

Control is now passed to the program COM2.

### Program COM2:

```
DEFINE DATA LOCAL
1 EMP VIEW OF EMPLOYEES
  2 NAME(A20)
  2 MIDDLE-NAME (A20)
  2 PERSONNEL-ID (A8)
1 SELECTNAME (A20)
END-DEFINE
*
SET KEY PF5 = '%CCC'
*
INPUT NO ERASE 'SELECT FIELD WITH CURSOR AND PRESS PF5'
*
MOVE *COM TO SELECTNAME
FIND EMP WITH NAME = SELECTNAME
  DISPLAY NAME PERSONNEL-ID
END-FIND
END
```

In this program, the terminal command %CCC is assigned to PF5. The terminal command copies all protected data from the line where the cursor is positioned to the system variable \*COM. This in-

formation is then available for further processing. This further processing is defined in the program lines shown in boldface.

The user can now position the cursor on the name that interests him; when he/she now presses PF5, further employee information is supplied.

```

SELECT FIELD WITH CURSOR AND PRESS PF5                                2006-08-12  09:44:25

      NAME
-----

ABELLAN
ACHIESON
ADAM <==  Cursor positioned on name for which more information is required
ADKINSON
ADKINSON
ADKINSON
ADKINSON
ADKINSON
ADKINSON
ADKINSON
ADKINSON
ADKINSON
ADKINSON
ADKINSON
AECKERLE
AFANASSIEV
AFANASSIEV
AHL
AKROYD
ALEMAN
ALESTIA

```

In this case, the personnel ID of the selected employee is displayed:

```

Page      1  2006-08-12  09:44:52

      NAME          PERSONNEL
-----          -----
ADAM                50005800

```

## Statements REINPUT/REINPUT FULL

If you wish to return to and re-execute an `INPUT` statement, you use the `REINPUT` statement. It is generally used to display a message indicating that the data input as a result of the previous `INPUT` statement were invalid.

If you specify the `FULL` option in a `REINPUT` statement, the corresponding `INPUT` statement will be re-executed fully:

- With an ordinary `REINPUT` statement (without `FULL` option), the contents of variables that were changed between the `INPUT` and `REINPUT` statement will not be displayed; that is, all variables on the screen will show the contents they had when the `INPUT` statement was originally executed.
- With a `REINPUT FULL` statement, all changes that have been made after the initial execution of the `INPUT` statement will be applied to the `INPUT` statement when it is re-executed; that is, all variables on the screen contain the values they had when the `REINPUT` statement was executed.
- If you wish to position the cursor to a specified field, you can use the `MARK` option, and to position to a particular position within a specified field, you use the `MARK POSITION` option.

The example below illustrates the use of `REINPUT FULL` with `MARK POSITION`.

```

DEFINE DATA LOCAL
1 #A (A10)
1 #B (N4)
1 #C (N4)
END-DEFINE
*
INPUT (AD=M) #A #B #C
IF #A = ' '
  COMPUTE #B = #B + #C
  RESET #C
  REINPUT FULL 'Enter a value' MARK POSITION 5 IN *#A
END-IF
END

```

The user enters 3 in field `#B` and 3 in field `#C` and presses `Enter`.

```
#A          #B      3 #C      3
```

The program requires field `#A` to be non-blank. The `REINPUT FULL` statement with `MARK POSITION 5 IN *#A` returns the input screen; the now modified variable `#B` contains the value 6 (after the `COMPUTE` calculation has been performed). The cursor is positioned to the 5th position in field `#A` ready for new input.

```
Enter name of field
#A  _      #B    6 #C    0
```

```
Enter a value
```

This is the screen that would be returned by the same statement, without the `FULL` option. Note that the variables `#B` and `#C` have been reset to their status at the time of execution of the `INPUT` statement (each field contains the value 3).

```
#A  _      #B    3 #C    3
```





# X

---

|                                        |     |
|----------------------------------------|-----|
| ■ 54 Natural Reserved Keywords .....   | 533 |
| ■ 55 Referenced Example Programs ..... | 551 |



# 54 Natural Reserved Keywords

---

- Alphabetical List of Natural Reserved Keywords ..... 534
- Performing a Check for Natural Reserved Keywords ..... 549

This chapter contains a list of all keywords that are reserved in the Natural programming language.

 **Important:** To avoid any naming conflicts, you are strongly recommended not to use Natural reserved keywords as names for variables.

## Alphabetical List of Natural Reserved Keywords

---

The following list is an overview of Natural reserved keywords and is for general information only. In case of doubt, use the [keyword check](#) function of the compiler.

[ [A](#) | [B](#) | [C](#) | [D](#) | [E](#) | [F](#) | [G](#) | [H](#) | [I](#) | [J](#) | [K](#) | [L](#) | [M](#) | [N](#) | [O](#) | [P](#) | [Q](#) | [R](#) | [S](#) | [T](#) | [U](#) | [V](#) | [W](#) | [X](#) | [Y](#) | [Z](#) ]

- A -

ABS  
ABSOLUTE  
ACCEPT  
ACTION  
ACTIVATION  
AD  
ADD  
AFTER  
AL  
ALARM  
ALL  
ALPHA  
ALPHABETICALLY  
AND  
ANY  
APPL  
APPLICATION  
ARRAY  
AS  
ASC  
ASCENDING  
ASSIGN  
ASSIGNING  
ASYNC  
AT  
ATN  
ATT  
ATTRIBUTES  
AUTH

AUTHORIZATION

AUTO

AVER

AVG

**- B -**

BACKOUT

BACKWARD

BASE

BEFORE

BETWEEN

BLOCK

BOT

BOTTOM

BREAK

BROWSE

BUT

BX

BY

**- C -**

CABINET

CALL

CALLDBPROC

CALLING

CALLNAT

CAP

CAPTIONED

CASE

CC

CD

CDID

CF

CHAR

CHARLENGTH

CHARPOSITION

CHILD

CIPH

CIPHER

CLASS

CLOSE

CLR

COALESCE

CODEPAGE

COMMAND  
COMMIT  
COMPOSE  
COMPRESS  
COMPUTE  
CONCAT  
CONDITION  
CONST  
CONSTANT  
CONTEXT  
CONTROL  
CONVERSATION  
COPIES  
COPY  
COS  
COUNT  
COUPLED  
CS  
CURRENT  
CURSOR  
CV

**- D -**

DATA  
DATAAREA  
DATE  
DAY  
DAYS  
DC  
DECIDE  
DECIMAL  
DEFINE  
DEFINITION  
DELETE  
DELIMITED  
DELIMITER  
DELIMITERS  
DESC  
DESCENDING  
DIALOG  
DIALOG-ID  
DIGITS  
DIRECTION  
DISABLED

DISP  
DISPLAY  
DISTINCT  
DIVIDE  
DL  
DLOGOFF  
DLOGON  
DNATIVE  
DNRET  
DO  
DOCUMENT  
DOEND  
DOWNLOAD  
DU  
DY  
DYNAMIC

- E -

EDITED  
EJ  
EJECT  
ELSE  
EM  
ENCODED  
END  
END-ALL  
END-BEFORE  
END-BREAK  
END-BROWSE  
END-CLASS  
END-DECIDE  
END-DEFINE  
END-ENDDATA  
END-ENDFILE  
END-ENDPAGE  
END-ERROR  
END-FILE  
END-FIND  
END-FOR  
END-FUNCTION  
END-HISTOGRAM  
ENDHOC  
END-IF  
END-INTERFACE

END-LOOP  
END-METHOD  
END-NOREC  
END-PARAMETERS  
END-PARSE  
END-PROCESS  
END-PROPERTY  
END-PROTOTYPE  
END-READ  
END-REPEAT  
END-RESULT  
END-SELECT  
END-SORT  
END-START  
END-SUBROUTINE  
END-TOPPAGE  
END-WORK  
ENDING  
ENTER  
ENTIRE  
ENTR  
EQ  
EQUAL  
ERASE  
ERROR  
ERRORS  
ES  
ESCAPE  
EVEN  
EVENT  
EVERY  
EXAMINE  
EXCEPT  
EXISTS  
EXIT  
EXP  
EXPAND  
EXPORT  
EXTERNAL  
EXTRACTING

**- F -**

FALSE  
FC



FETCH  
FIELD  
FIELDS  
FILE  
FILL  
FILLER  
FINAL  
FIND  
FIRST  
FL  
FLOAT  
FOR  
FORM  
FORMAT  
FORMATTED  
FORMATTING  
FORMS  
FORWARD  
FOUND  
FRAC  
FRAMED  
FROM  
FS  
FULL  
FUNCTION  
FUNCTIONS

**- G -**

GC  
GE  
GEN  
GENERATED  
GET  
GFID  
GIVE  
GIVING  
GLOBAL  
GLOBALS  
GREATER  
GT  
GUI

**- H -**

HANDLE

HAVING  
HC  
HD  
HE  
HEADER  
HEX  
HISTOGRAM  
HOLD  
HORIZ  
HORIZONTALLY  
HOUR  
HOURS  
HW

**- I -**

IA  
IC  
ID  
IDENTICAL  
IF  
IGNORE  
IM  
IMMEDIATE  
IMPORT  
IN  
INC  
INCCONT  
INCDIC  
INCDIR  
INCLUDE  
INCLUDED  
INCLUDING  
INCMAC  
INDEPENDENT  
INDEX  
INDEXED  
INDICATOR  
INIT  
INITIAL  
INNER  
INPUT  
INSENSITIVE  
INSERT  
INT

INTEGER  
INTERCEPTED  
INTERFACE  
INTERFACE4  
INTERMEDIATE  
INTERSECT  
INTO  
INVERTED  
INVESTIGATE  
IP  
IS  
ISN

**- J -**

JOIN  
JUST  
JUSTIFIED

**- K -**

KD  
KEEP  
KEY  
KEYS

**- L -**

LANGUAGE  
LAST  
LC  
LE  
LEAVE  
LEAVING  
LEFT  
LENGTH  
LESS  
LEVEL  
LIB  
LIBPW  
LIBRARY  
LIBRARY-PASSWORD  
LIKE  
LIMIT  
LINDICATOR  
LINES

LISTED  
LOCAL  
LOCKS  
LOG  
LOG-LS  
LOG-PS  
LOGICAL  
LOOP  
LOWER  
LS  
LT

- M -

MACROAREA  
MAP  
MARK  
MASK  
MAX  
MC  
MCG  
MESSAGES  
METHOD  
MGID  
MICROSECOND  
MIN  
MINUTE  
MODAL  
MODIFIED  
MODULE  
MONTH  
MORE  
MOVE  
MOVING  
MP  
MS  
MT  
MULTI-FETCH  
MULTIPLY

- N -

NAME  
NAMED  
NAMESPACE  
NATIVE

NAVER  
NC  
NCOUNT  
NE  
NEWPAGE  
NL  
NMIN  
NO  
NODE  
NOHDR  
NONE  
NORMALIZE  
NORMALIZED  
NOT  
NOTIT  
NOTITLE  
NULL  
NULL-HANDLE  
NUMBER  
NUMERIC

**- O -**

OBJECT  
OBTAIN  
OCCURRENCES  
OF  
OFF  
OFFSET  
OLD  
ON  
ONCE  
ONLY  
OPEN  
OPTIMIZE  
OPTIONAL  
OPTIONS  
OR  
ORDER  
OUTER  
OUTPUT

**- P -**

PACKAGESET  
PAGE

PARAMETER  
PARAMETERS  
PARENT  
PARSE  
PASS  
PASSW  
PASSWORD  
PATH  
PATTERN  
PA1  
PA2  
PA3  
PC  
PD  
PEN  
PERFORM  
PF $n$  ( $n = 1$  to 9)  
PF $nn$  ( $nn = 10$  to 99)  
PGDN  
PGUP  
PGM  
PHYSICAL  
PM  
POLICY  
POS  
POSITION  
PREFIX  
PRINT  
PRINTER  
PROCESS  
PROCESSING  
PROFILE  
PROGRAM  
PROPERTY  
PROTOTYPE  
PRTY  
PS  
PT  
PW  
  
- Q -  
  
QUARTER  
QUERYNO

**- R -**

RD  
READ  
READONLY  
REC  
RECORD  
RECORDS  
RECURSIVELY  
REDEFINE  
REDUCE  
REFERENCED  
REFERENCING  
REINPUT  
REJECT  
REL  
RELATION  
RELATIONSHIP  
RELEASE  
REMAINDER  
REPEAT  
REPLACE  
REPORT  
REPORTER  
REPOSITION  
REQUEST  
REQUIRED  
RESET  
RESETTING  
RESIZE  
RESPONSE  
RESTORE  
RESULT  
RET  
RETAIN  
RETAINED  
RETRY  
RETURN  
RETURNS  
REVERSED  
RG  
RIGHT  
ROLLBACK  
ROUNDED  
ROUTINE

ROW  
ROWS  
RR  
RS  
RULEVAR  
RUN

- S -

SA  
SAME  
SCAN  
SCREEN  
SCROLL  
SECOND  
SELECT  
SELECTION  
SEND  
SENSITIVE  
SEPARATE  
SEQUENCE  
SERVER  
SET  
SETS  
SETTIME  
SF  
SG  
SGN  
SHORT  
SHOW  
SIN  
SINGLE  
SIZE  
SKIP  
SL  
SM  
SOME  
SORT  
SORTED  
SORTKEY  
SOUND  
SPACE  
SPECIFIED  
SQL  
SQLID



SQRT  
STACK  
START  
STARTING  
STATEMENT  
STATIC  
STATUS  
STEP  
STOP  
STORE  
SUBPROGRAM  
SUBPROGRAMS  
SUBROUTINE  
SUBSTR  
SUBSTRING  
SUBTRACT  
SUM  
SUPPRESS  
SUPPRESSED  
SUSPEND  
SYMBOL  
SYNC  
SYSTEM

- T -

TAN  
TC  
TERMINATE  
TEXT  
TEXTAREA  
TEXTVARIABLE  
THAN  
THEM  
THEN  
THRU  
TIME  
TIMESTAMP  
TIMEZONE  
TITLE  
TO  
TOP  
TOTAL  
TP  
TR

TRAILER  
TRANSACTION  
TRANSFER  
TRANSLATE  
TREQ  
TRUE  
TS  
TYPE  
TYPES

**- U -**

UC  
UNDERLINED  
UNION  
UNIQUE  
UNKNOWN  
UNTIL  
UPDATE  
UPLOAD  
UPPER  
UR  
USED  
USER  
USING

**- V -**

VAL  
VALUE  
VALUES  
VARGRAPHIC  
VARIABLE  
VARIABLES  
VERT  
VERTICALLY  
VIA  
VIEW

**- W -**

WH  
WHEN  
WHERE  
WHILE  
WINDOW

WITH  
WORK  
WRITE  
WITH\_CTE

- X -

XML

- Y -

YEAR

- Z -

ZD  
ZP

## Performing a Check for Natural Reserved Keywords

---

There is a subset of Natural keywords which, when used as names for variables, would be ambiguous. These are in particular keywords which identify Natural statements (ADD, FIND, etc.) or system functions (ABS, SUM, etc.). If you use such a keyword as the name of a variable, you cannot use this variable in the context of optional operands (with CALLNAT, WRITE, etc.).

Example:

```
DEFINE DATA LOCAL
1 ADD (A10)
END-DEFINE
CALLNAT 'MYSUB' ADD 4      /* ADD is regarded as ADD statement
END
```

To check variable names in a programming object against such Natural reserved keywords, you can use the Natural profile parameter `KCHECK`

The following table contains a list of Natural reserved keywords that are checked by `KC` or `KCHECK`.

| A - D      | E - F          | G - P       | R - S     | T - W     |
|------------|----------------|-------------|-----------|-----------|
| A-AVER     | EJECT          | GET         | READ      | TAN       |
| ABS        | ELSE           | HISTOGRAM   | REDEFINE  | TERMINATE |
| ACCEPT     | END            | IF          | REDUCE    | TOP       |
| ADD        | END-ALL        | IGNORE      | REINPUT   | TOTAL     |
| ALL        | END-BEFORE     | IMPORT      | REJECT    | TRANSFER  |
| A-MAX      | END-BREAK      | INCCONT     | RELEASE   | TRUE      |
| A-MIN      | END-BROWSE     | INCDIC      | REPEAT    | UNTIL     |
| A-NAVER    | END-DECIDE     | INCDIR      | REQUEST   | UPDATE    |
| A-NCOUNT   | END-ENDDATA    | INCLUDE     | RESET     | UPLOAD    |
| A-NMIN     | END-DECIDE     | INCMAC      | RESIZE    | VAL       |
| ANY        | END-ENDDATA    | INPUT       | RESTORE   | VALUE     |
| ASSIGN     | END-ENDFILE    | INSERT      | RET       | VALUES    |
| A-SUM      | END-ENDPAGE    | INT         | RETRY     | WASTE     |
| AT         | END-ERROR      | INVESTIGATE | RETURN    | WHEN      |
| ATN        | END-FILE       | LIMIT       | ROLLBACK  | WHILE     |
| AVER       | END-FIND       | LOG         | RULEVAR   | WITH_CTE  |
| BACKOUT    | END-FOR        | LOOP        | RUN       | WRITE     |
| BEFORE     | END-HISTOGRAM  | MAP         | SELECT    |           |
| BREAK      | ENDHOC         | MAX         | SEND      |           |
| BROWSE     | END-IF         | MIN         | SEPARATE  |           |
| CALL       | END-LOOP       | MOVE        | SET       |           |
| CALLDBPROC | END-NOREC      | MULTIPLY    | SETTIME   |           |
| CALLNAT    | END-PARSE      | NAVER       | SGN       |           |
| CLOSE      | END-PROCESS    | NCOUNT      | SHOW      |           |
| COMMIT     | END-READ       | NEWPAGE     | SIN       |           |
| COMPOSE    | END-REPEAT     | NMIN        | SKIP      |           |
| COMPRESS   | END-RESULT     | NONE        | SORT      |           |
| COMPUTE    | END-SELECT     | NULL-HANDLE | SORTKEY   |           |
| COPY       | END-SORT       | OBTAIN      | SQRT      |           |
| COS        | END-START      | OLD         | STACK     |           |
| COUNT      | END-SUBROUTINE | ON          | START     |           |
| CREATE     | END-TOPPAGE    | OPEN        | STOP      |           |
| DECIDE     | END-WORK       | OPTIONS     | STORE     |           |
| DEFINE     | ENTIRE         | PARSE       | SUBSTR    |           |
| DELETE     | ESCAPE         | PASSW       | SUBSTRING |           |
| DISPLAY    | EXAMINE        | PERFORM     | SUBTRACT  |           |
| DIVIDE     | EXP            | POS         | SUM       |           |
| DLOGOFF    | EXPAND         | PRINT       | SUSPEND   |           |
| DLOGON     | EXPORT         | PROCESS     |           |           |
| DNATIVE    | FALSE          |             |           |           |
| DO         | FETCH          |             |           |           |
| DOEND      | FIND           |             |           |           |
| DOWNLOAD   | FOR            |             |           |           |
|            | FORMAT         |             |           |           |
|            | FRAC           |             |           |           |

By default, no keyword check is performed.

# 55

## Referenced Example Programs

---

|                                                        |     |
|--------------------------------------------------------|-----|
| ▪ READ Statement .....                                 | 552 |
| ▪ FIND Statement .....                                 | 553 |
| ▪ Nested READ and FIND Statements .....                | 557 |
| ▪ ACCEPT and REJECT Statements .....                   | 559 |
| ▪ AT START OF DATA and AT END OF DATA Statements ..... | 561 |
| ▪ DISPLAY and WRITE Statements .....                   | 564 |
| ▪ DISPLAY Statement .....                              | 568 |
| ▪ Column Headers .....                                 | 569 |
| ▪ Field-Output-Relevant Parameters .....               | 571 |
| ▪ Edit Masks .....                                     | 577 |
| ▪ DISPLAY VERT with WRITE Statement .....              | 580 |
| ▪ AT BREAK Statement .....                             | 581 |
| ▪ COMPUTE, MOVE and COMPRESS Statements .....          | 582 |
| ▪ System Variables .....                               | 585 |
| ▪ System Functions .....                               | 588 |

This chapter contains some additional example programs that are referenced in the *Programming Guide*.

## READ Statement

---

The following example is referenced in the section *Statements for Database Access*.

### READX03 - READ statement (with LOGICAL clause)

```

** Example 'READX03': READ (with LOGICAL clause)
*****
DEFINE DATA LOCAL
1 EMPLOY-VIEW VIEW OF EMPLOYEES
  2 NAME
  2 PERSONNEL-ID
  2 JOB-TITLE
END-DEFINE
*
LIMIT 8
READ EMPLOY-VIEW LOGICAL BY PERSONNEL-ID
  DISPLAY NOTITLE *ISN      NAME
                  'PERS-NO' PERSONNEL-ID
                  'POSITION' JOB-TITLE
END-READ
END
    
```

Output of Program READX03:

| ISN | NAME      | PERS-NO  | POSITION            |
|-----|-----------|----------|---------------------|
| 204 | SCHINDLER | 11100102 | PROGRAMMIERER       |
| 205 | SCHIRM    | 11100105 | SYSTEMPROGRAMMIERER |
| 206 | SCHMITT   | 11100106 | OPERATOR            |
| 207 | SCHMIDT   | 11100107 | SEKRETAERIN         |
| 208 | SCHNEIDER | 11100108 | SACHBEARBEITER      |
| 209 | SCHNEIDER | 11100109 | SEKRETAERIN         |
| 210 | BUNGERT   | 11100110 | SYSTEMPROGRAMMIERER |
| 211 | THIELE    | 11100111 | SEKRETAERIN         |

## FIND Statement

The following examples are referenced in the section *Statements for Database Access*.

### FINDX07 - FIND statement (with several clauses)

```
** Example 'FINDX07': FIND (with several clauses)
*****
DEFINE DATA LOCAL
1 EMPLOY-VIEW VIEW OF EMPLOYEES
  2 NAME
  2 FIRST-NAME
  2 CITY
  2 SALARY (1)
  2 CURR-CODE (1)
END-DEFINE
*
FIND EMPLOY-VIEW WITH PHONETIC-NAME = 'JONES' OR = 'BECKR'
                      AND CITY      = 'BOSTON' THRU 'NEW YORK'
                      BUT NOT       'CHAPEL HILL'
                      SORTED BY NAME
                      WHERE SALARY (1) < 28000
  DISPLAY NOTITLE NAME FIRST-NAME CITY SALARY (1)
END-FIND
END
```

Output of Program FINDX07:

| NAME  | FIRST-NAME | CITY      | ANNUAL SALARY |
|-------|------------|-----------|---------------|
| BAKER | PAULINE    | DERBY     | 4450          |
| JONES | MARTHA     | KALAMAZOO | 21000         |
| JONES | KEVIN      | DERBY     | 7000          |

### FINDX08 - FIND statement (with LIMIT)

```
** Example 'FINDX08': FIND (with LIMIT)
**
** Demonstrates FIND statement with LIMIT option to
** terminate program with an error message if the
** number of records selected exceeds a specified
** limit (no output).
*****
DEFINE DATA LOCAL
```

## Referenced Example Programs

---

```
1 EMPLOY-VIEW VIEW OF EMPLOYEES
  2 NAME
  2 JOB-TITLE
END-DEFINE
*
FIND EMPLOY-VIEW WITH LIMIT (5) JOB-TITLE = 'SALES PERSON'
  DISPLAY NAME JOB-TITLE
END-FIND
END
```

### Runtime Error Caused by Program FINDX08:

NAT1005 More records found than specified in search limit.

### FINDX09 - FIND statement (using \*NUMBER, \*COUNTER, \*ISN)

```
** Example 'FINDX09': FIND (using *NUMBER, *COUNTER, *ISN)
*****
DEFINE DATA LOCAL
1 EMPLOY-VIEW VIEW OF EMPLOYEES
  2 DEPT
  2 NAME
END-DEFINE
*
FIND EMPLOY-VIEW WITH CITY = 'BOSTON'
  WHERE DEPT = 'TECH00' THRU 'TECH10'
  DISPLAY NOTITLE
    'COUNTER' *COUNTER NAME DEPT 'ISN' *ISN
  AT START OF DATA
    WRITE '(TOTAL NUMBER IN BOSTON:' *NUMBER ')' /
  END-START
END-FIND
END
```

### Output of Program FINDX09:

```
COUNTER          NAME          DEPARTMENT          ISN
                NAME          CODE
-----
(TOTAL NUMBER IN BOSTON:          7 )

      1 STANWOOD          TECH10          782
      2 PERREAULT        TECH10          842
```



**FINDX10 - FIND statement (combined with READ)**

```

** Example 'FINDX10': FIND (combined with READ)
*****
DEFINE DATA LOCAL
1 EMPLOY-VIEW VIEW OF EMPLOYEES
  2 PERSONNEL-ID
  2 NAME
  2 FIRST-NAME
1 VEHIC-VIEW VIEW OF VEHICLES
  2 PERSONNEL-ID
  2 MAKE
END-DEFINE
*
LIMIT 15
*
EMP. READ EMPLOY-VIEW BY NAME STARTING FROM 'JONES'
  VEH. FIND VEHIC-VIEW WITH PERSONNEL-ID = PERSONNEL-ID (EMP.)
  IF NO RECORDS FOUND
    MOVE '*** NO CAR ***' TO MAKE
  END-NOREC
  DISPLAY NOTITLE
    NAME (EMP.) (IS=ON)
    FIRST-NAME (EMP.) (IS=ON)
    MAKE (VEH.)
  END-FIND
END-READ
END

```

**Output of Program FINDX10:**

| NAME      | FIRST-NAME | MAKE           |
|-----------|------------|----------------|
| JONES     | VIRGINIA   | CHRYSLER       |
|           | MARSHA     | CHRYSLER       |
|           |            | CHRYSLER       |
|           | ROBERT     | GENERAL MOTORS |
|           | LILLY      | FORD           |
|           |            | MG             |
|           | EDWARD     | GENERAL MOTORS |
|           | MARTHA     | GENERAL MOTORS |
|           | LAUREL     | GENERAL MOTORS |
|           | KEVIN      | DATSUN         |
|           | GREGORY    | FORD           |
| JOPER     | MANFRED    | *** NO CAR *** |
| JOUSSELIN | DANIEL     | RENAULT        |
| JUBE      | GABRIEL    | *** NO CAR *** |
| JUNG      | ERNST      | *** NO CAR *** |

```
JUNKIN          JEREMY          *** NO CAR ***
KAISER          REINER          *** NO CAR ***
```

**FINDX11 - FIND NUMBER statement (with \*NUMBER)**

```
** Example 'FINDX11': FIND NUMBER (with *NUMBER)
*****
DEFINE DATA LOCAL
1 EMPLOY-VIEW VIEW OF EMPLOYEES
  2 FIRST-NAME
  2 NAME
  2 CITY
  2 JOB-TITLE
  2 SALARY          (1)
*
1 #PERCENT          (N.2)
1 REDEFINE #PERCENT
  2 #WHOLE-NBR      (N2)
1 #ALL-BOST        (N3.2)
1 #SECR-ONLY       (N3.2)
1 #BOST-NBR        (N3)
1 #SECR-NBR        (N3)
END-DEFINE
*
F1. FIND NUMBER EMPLOY-VIEW WITH CITY = 'BOSTON'
F2. FIND NUMBER EMPLOY-VIEW WITH CITY = 'BOSTON'
      AND JOB-TITLE = 'SECRETARY'
*
MOVE *NUMBER(F1.) TO #ALL-BOST #BOST-NBR
MOVE *NUMBER(F2.) TO #SECR-ONLY #SECR-NBR
DIVIDE #ALL-BOST INTO #SECR-ONLY GIVING #PERCENT
*
WRITE TITLE LEFT JUSTIFIED UNDERLINED
  'There are' #BOST-NBR 'employees in the Boston offices.' /
  #SECR-NBR '(=' #WHOLE-NBR (EM=99%')) 'are secretaries.'
*
SKIP 1
FIND EMPLOY-VIEW WITH CITY          = 'BOSTON'
      AND JOB-TITLE = 'SECRETARY'
  DISPLAY NAME FIRST-NAME JOB-TITLE SALARY (1)
END-FIND
END
```

Output of Program FINDX11:

There are 7 employees in the Boston offices.  
3 (= 42%) are secretaries.

| NAME   | FIRST-NAME | CURRENT POSITION | ANNUAL SALARY |
|--------|------------|------------------|---------------|
| SHAW   | LESLIE     | SECRETARY        | 18000         |
| CREMER | WALT       | SECRETARY        | 20000         |
| COHEN  | JOHN       | SECRETARY        | 16000         |

## Nested READ and FIND Statements

The following examples are referenced in the section *Database Processing Loops*.

### READX04 - READ statement (in combination with FIND and the system variables \*NUMBER and \*COUNTER)

```
** Example 'READX04': READ (in combination with FIND and the system
**                          variables *NUMBER and *COUNTER)
*****
DEFINE DATA LOCAL
1 EMPLOY-VIEW VIEW OF EMPLOYEES
  2 PERSONNEL-ID
  2 NAME
  2 FIRST-NAME
1 VEHIC-VIEW VIEW OF VEHICLES
  2 PERSONNEL-ID
  2 MAKE
END-DEFINE
*
LIMIT 10
RD. READ EMPLOY-VIEW BY NAME STARTING FROM 'JONES'
  FD. FIND VEHIC-VIEW WITH PERSONNEL-ID = PERSONNEL-ID (RD.)
  IF NO RECORDS FOUND
    ENTER
  END-NOREC
  /*
  DISPLAY NOTITLE
    *COUNTER (RD.)(NL=8) NAME          (AL=15) FIRST-NAME (AL=10)
    *NUMBER (FD.)(NL=8) *COUNTER (FD.)(NL=8) MAKE
  END-FIND
END-READ
END
```

Output of Program READX04:

| CNT | NAME  | FIRST-NAME | NMBR | CNT | MAKE           |
|-----|-------|------------|------|-----|----------------|
| 1   | JONES | VIRGINIA   | 1    | 1   | CHRYSLER       |
| 2   | JONES | MARSHA     | 2    | 1   | CHRYSLER       |
| 2   | JONES | MARSHA     | 2    | 2   | CHRYSLER       |
| 3   | JONES | ROBERT     | 1    | 1   | GENERAL MOTORS |
| 4   | JONES | LILLY      | 2    | 1   | FORD           |
| 4   | JONES | LILLY      | 2    | 2   | MG             |
| 5   | JONES | EDWARD     | 1    | 1   | GENERAL MOTORS |
| 6   | JONES | MARTHA     | 1    | 1   | GENERAL MOTORS |
| 7   | JONES | LAUREL     | 1    | 1   | GENERAL MOTORS |
| 8   | JONES | KEVIN      | 1    | 1   | DATSUN         |
| 9   | JONES | GREGORY    | 1    | 1   | FORD           |
| 10  | JOPER | MANFRED    | 0    | 0   |                |

**LIMITX01 - LIMIT statement (for READ, FIND loop processing)**

```

** Example 'LIMITX01': LIMIT (for READ, FIND loop processing)
*****
DEFINE DATA LOCAL
1 EMPLOY-VIEW VIEW OF EMPLOYEES
  2 PERSONNEL-ID
  2 FIRST-NAME
  2 NAME
1 VEH-VIEW VIEW OF VEHICLES
  2 PERSONNEL-ID
  2 MAKE
END-DEFINE
*
LIMIT 4
*
READ EMPLOY-VIEW BY NAME STARTING FROM 'A'
  FIND VEH-VIEW WITH PERSONNEL-ID = EMPLOY-VIEW.PERSONNEL-ID
  IF NO RECORDS FOUND
    MOVE 'NO CAR' TO MAKE
  END-NOREC
  DISPLAY PERSONNEL-ID NAME FIRST-NAME MAKE
  END-FIND
END-READ
END

```

Output of Program LIMITX01:

| Page         | 1        |            | 04-12-13 14:01:57 |
|--------------|----------|------------|-------------------|
| PERSONNEL-ID | NAME     | FIRST-NAME | MAKE              |
| 30000231     | ABELLAN  | KEPA       | NO CAR            |
|              | ACHIESON | ROBERT     | FORD              |
|              | ADAM     | SIMONE     | NO CAR            |
| 20008800     | ADKINSON | JEFF       | GENERAL MOTORS    |

## ACCEPT and REJECT Statements

The following examples are referenced in the section *Selecting Records Using ACCEPT/REJECT*.

### ACCEPX04 - ACCEPT IF ... LESS THAN ... statement

```

** Example 'ACCEPX04': ACCEPT IF ... LESS THAN ...
*****
DEFINE DATA LOCAL
1 EMPLOY-VIEW VIEW OF EMPLOYEES
  2 PERSONNEL-ID
  2 NAME
  2 JOB-TITLE
  2 SALARY (1)
END-DEFINE
*
LIMIT 20
READ EMPLOY-VIEW BY PERSONNEL-ID = '20017000'
  ACCEPT IF SALARY (1) LESS THAN 38000
  DISPLAY NOTITLE PERSONNEL-ID NAME JOB-TITLE SALARY (1)
END-READ
END

```

### Output of Program ACCEPX04:

| PERSONNEL ID | NAME    | CURRENT POSITION | ANNUAL SALARY |
|--------------|---------|------------------|---------------|
| 20017000     | CREMER  | ANALYST          | 34000         |
| 20017100     | MARKUSH | TRAINEE          | 22000         |
| 20017400     | NEEDHAM | PROGRAMMER       | 32500         |
| 20017500     | JACKSON | PROGRAMMER       | 33000         |
| 20017600     | PIETSCH | SECRETARY        | 22000         |
| 20017700     | PAUL    | SECRETARY        | 23000         |

|          |         |              |       |
|----------|---------|--------------|-------|
| 20018000 | FARRIS  | PROGRAMMER   | 30500 |
| 20018100 | EVANS   | PROGRAMMER   | 31000 |
| 20018200 | HERZOG  | PROGRAMMER   | 31500 |
| 20018300 | LORIE   | SALES PERSON | 28000 |
| 20018400 | HALL    | SALES PERSON | 30000 |
| 20018500 | JACKSON | MANAGER      | 36000 |
| 20018800 | SMITH   | SECRETARY    | 24000 |
| 20018900 | LOWRY   | SECRETARY    | 25000 |

**ACCEPX05 - ACCEPT IF ... AND ... statement**

```

** Example 'ACCEPX05': ACCEPT IF ... AND ...
*****
DEFINE DATA LOCAL
1 EMPLOY-VIEW VIEW OF EMPLOYEES
  2 NAME
  2 CITY
  2 JOB-TITLE
  2 SALARY (1:2)
END-DEFINE
*
LIMIT 6
READ EMPLOY-VIEW PHYSICAL WHERE SALARY(2) > 0
  ACCEPT IF SALARY(1) > 10000
    AND SALARY(1) < 50000
  DISPLAY (AL=15) 'SALARY I' SALARY (1) 'SALARY II' SALARY (2)
    NAME JOB-TITLE CITY
END-READ
END

```

**Output of Program ACCEPX05:**

Page 1 04-12-13 14:05:28

| SALARY I | SALARY II | NAME      | CURRENT POSITION | CITY       |
|----------|-----------|-----------|------------------|------------|
| 48000    | 46000     | SPENGLER  | SACHBEARBEITER   | DARMSTADT  |
| 45000    | 40000     | SPECK     | SACHBEARBEITER   | DARMSTADT  |
| 48000    | 46000     | SCHINDLER | PROGRAMMIERER    | HEPPENHEIM |
| 36000    | 32000     | SCHMIDT   | SEKRETAERIN      | HEPPENHEIM |

**ACCEPX06 - REJECT IF ... OR ... statement**

```

** Example 'ACCEPX06': REJECT IF ... OR ...
*****
DEFINE DATA LOCAL
1 EMPLOY-VIEW VIEW OF EMPLOYEES
  2 PERSONNEL-ID
  2 SALARY (1)
  2 JOB-TITLE
  2 CITY
  2 NAME
END-DEFINE
*
LIMIT 20
READ EMPLOY-VIEW LOGICAL BY PERSONNEL-ID = '20017000'
  REJECT IF SALARY (1) < 20000
    OR SALARY (1) > 26000
  DISPLAY NOTITLE SALARY (1) NAME JOB-TITLE CITY
END-READ
END

```

**Output of Program ACCEPX06:**

| ANNUAL<br>SALARY | NAME    | CURRENT<br>POSITION | CITY          |
|------------------|---------|---------------------|---------------|
| 22000            | MARKUSH | TRAINEE             | LOS ANGELES   |
| 22000            | PIETSCH | SECRETARY           | VISTA         |
| 23000            | PAUL    | SECRETARY           | NORFOLK       |
| 24000            | SMITH   | SECRETARY           | SILVER SPRING |
| 25000            | LOWRY   | SECRETARY           | LEXINGTON     |

**AT START OF DATA and AT END OF DATA Statements**

The following examples are referenced in the section [AT START/END OF DATA Statements](#).

**ATENDX01 - AT END OF DATA statement**

```

** Example 'ATENDX01': AT END OF DATA
*****
DEFINE DATA LOCAL
1 EMPLOY-VIEW VIEW OF EMPLOYEES
  2 PERSONNEL-ID
  2 NAME
  2 JOB-TITLE
END-DEFINE
*
READ (6) EMPLOY-VIEW BY PERSONNEL-ID FROM '20017000'
  DISPLAY NOTITLE NAME JOB-TITLE
  AT END OF DATA
    WRITE / 'LAST PERSON SELECTED:' OLD(NAME)
  END-ENDDATA
END-READ
END
    
```

**Output of Program ATENDX01:**

```

          NAME                CURRENT
                        POSITION
-----
CREMER                ANALYST
MARKUSH                TRAINEE
GEE                    MANAGER
KUNEY                  DBA
NEEDHAM                PROGRAMMER
JACKSON                PROGRAMMER

LAST PERSON SELECTED: JACKSON
    
```

**ATSTAX02 - AT START OF DATA statement**

```

** Example 'ATSTAX02': AT START OF DATA
*****
DEFINE DATA LOCAL
1 EMPLOY-VIEW VIEW OF EMPLOYEES
  2 PERSONNEL-ID
  2 FIRST-NAME
  2 NAME
  2 SALARY      (1)
  2 CURR-CODE  (1)
  2 BONUS      (1,1)
END-DEFINE
*
    
```



```

LIMIT 3
FIND EMPLOY-VIEW WITH CITY = 'MADRID'
  DISPLAY NAME FIRST-NAME SALARY(1) BONUS(1,1) CURR-CODE (1)
  /*
  AT START OF DATA
    WRITE NOTITLE *DAT4E /
  END-START
END-FIND
END

```

#### Output of Program ATSTAX02:

| NAME         | FIRST-NAME | ANNUAL<br>SALARY | BONUS | CURRENCY<br>CODE |
|--------------|------------|------------------|-------|------------------|
| -----        |            |                  |       |                  |
| 13/12/2004   |            |                  |       |                  |
| DE JUAN      | JAVIER     | 1988000          |       | 0 PTA            |
| DE LA MADRID | ANSELMO    | 3120000          |       | 0 PTA            |
| PINERO       | PAULA      | 1756000          |       | 0 PTA            |

#### WRITEX09 - WRITE statement (in combination with AT END OF DATA)

```

** Example 'WRITEX09': WRITE (in combination with AT END OF DATA )
*****
DEFINE DATA LOCAL
1 EMPLOY-VIEW VIEW OF EMPLOYEES
  2 CITY
  2 NAME
  2 BIRTH
  2 JOB-TITLE
  2 DEPT
END-DEFINE
*
READ (3) EMPLOY-VIEW BY CITY
  DISPLAY NOTITLE NAME BIRTH (EM=YYYY-MM-DD) JOB-TITLE
  WRITE 38T 'DEPT CODE:' DEPT
  /*
  AT END OF DATA
    WRITE / 'LAST PERSON SELECTED:' OLD(NAME)
  END-ENDDATA
  SKIP 1
END-READ
END

```

#### Output of Program WRITEX09:

| NAME                         | DATE<br>OF<br>BIRTH | CURRENT<br>POSITION             |
|------------------------------|---------------------|---------------------------------|
| -----                        |                     |                                 |
| SENKO                        | 1971-09-11          | PROGRAMMER<br>DEPT CODE: TECH10 |
| GODEFROY                     | 1949-01-09          | COMPTABLE<br>DEPT CODE: COMPO2  |
| CANALE                       | 1942-01-01          | CONSULTANT<br>DEPT CODE: TECH03 |
| LAST PERSON SELECTED: CANALE |                     |                                 |

## DISPLAY and WRITE Statements

---

The following examples are referenced in the section *Statements DISPLAY and WRITE*.

### DISPLX13 - DISPLAY statement (compare with WRITEX08 using WRITE)

```

** Example 'DISPLX13': DISPLAY (compare with WRITEX08 using WRITE)
*****
DEFINE DATA LOCAL
1 EMPLOY-VIEW VIEW OF EMPLOYEES
  2 PERSONNEL-ID
  2 FIRST-NAME
  2 NAME
  2 SALARY (2)
  2 BONUS (1,1)
  2 CITY
END-DEFINE
*
LIMIT 2
READ EMPLOY-VIEW WITH CITY = 'CHAPEL HILL' WHERE BONUS(1,1) NE 0
/*
  DISPLAY 'PERS/ID' PERSONNEL-ID  NAME / FIRST-NAME
          '***' '=' SALARY(1:2) 'BONUS' BONUS(1,1) CITY (AL=15)
/*
  SKIP 1
END-READ
END

```

Output of Program DISPLX13:

```

Page      1                                     04-12-13  14:11:28

  PERS      NAME      ANNUAL      BONUS      CITY
  ID        FIRST-NAME  SALARY
-----
20027000 CUMMINGS      **      41000      1500 CHAPEL HILL
          PUALA
          **      38900
20000200 WOOLSEY      **      26000      3000 CHAPEL HILL
          LOUISE
          **      24700

```

### WRITEX08 - WRITE statement (compare with DISPLX13 using DISPLAY)

```

** Example 'WRITEX08': WRITE (compare with DISPLX13 using DISPLAY)
*****
DEFINE DATA LOCAL
1 EMPLOY-VIEW VIEW OF EMPLOYEES
  2 PERSONNEL-ID
  2 FIRST-NAME
  2 NAME
  2 SALARY (2)
  2 BONUS (1,1)
  2 CITY
END-DEFINE
*
LIMIT 2
READ EMPLOY-VIEW WITH CITY = 'CHAPEL HILL' WHERE BONUS(1,1) NE 0
/*
  WRITE 'PERS/ID' PERSONNEL-ID  NAME / FIRST-NAME
        '**' '=' SALARY(1:2) 'BONUS' BONUS(1,1) CITY (AL=15)
/*
  SKIP 1
END-READ
END

```

### Output of Program WRITEX08:

```

Page      1                                     04-12-13  14:12:43

PERS/ID 20027000 CUMMINGS
PUALA      ** ANNUAL SALARY:      41000      38900 BONUS      1500
CHAPEL HILL

PERS/ID 20000200 WOOLSEY
LOUISE     ** ANNUAL SALARY:      26000      24700 BONUS      3000
CHAPEL HILL

```

**DISPLX14 - DISPLAY statement (with AL, SF and nX)**

```

** Example 'DISPLX14': DISPLAY (with AL, SF and nX)
*****
DEFINE DATA LOCAL
1 EMPLOY-VIEW VIEW OF EMPLOYEES
  2 FIRST-NAME
  2 NAME
  2 ADDRESS-LINE (1)
  2 TELEPHONE
    3 AREA-CODE
    3 PHONE
  2 CITY
END-DEFINE
*
READ (3) EMPLOY-VIEW BY NAME STARTING FROM 'W'
  DISPLAY (AL=15 SF=5) NAME CITY / ADDRESS-LINE(1) 2X TELEPHONE
  SKIP 1
END-READ
END
    
```

**Output of Program DISPLX14:**

|           |                               |              |           |          |
|-----------|-------------------------------|--------------|-----------|----------|
| Page      | 1                             |              | 04-12-13  | 14:14:00 |
| NAME      | CITY<br>ADDRESS               | AREA<br>CODE | TELEPHONE |          |
| -----     | -----                         | -----        | -----     |          |
| WABER     | HEIDELBERG<br>ERBACHERSTR. 78 | 06221        | 456452    |          |
| WADSWORTH | DERBY<br>56 PINECROFT CO      | 0332         | 515365    |          |
| WAGENBACH | FRANKFURT<br>BECKERSTR. 4     | 069          | 983218    |          |

**WRITEX09 - WRITE statement (in combination with AT END OF DATA)**

```

** Example 'WRITEX09': WRITE (in combination with AT END OF DATA )
*****
DEFINE DATA LOCAL
1 EMPLOY-VIEW VIEW OF EMPLOYEES
  2 CITY
  2 NAME
  2 BIRTH
  2 JOB-TITLE
  2 DEPT
END-DEFINE
*
READ (3) EMPLOY-VIEW BY CITY
  DISPLAY NOTITLE NAME BIRTH (EM=YYYY-MM-DD) JOB-TITLE
  WRITE 38T 'DEPT CODE:' DEPT
  /*
  AT END OF DATA
    WRITE / 'LAST PERSON SELECTED:' OLD(NAME)
  END-ENDDATA
  SKIP 1
END-READ
END

```

**Output of Program WRITEX09:**

| NAME                         | DATE<br>OF<br>BIRTH | CURRENT<br>POSITION             |
|------------------------------|---------------------|---------------------------------|
| -----                        | -----               | -----                           |
| SENKO                        | 1971-09-11          | PROGRAMMER<br>DEPT CODE: TECH10 |
| GODEFROY                     | 1949-01-09          | COMPTABLE<br>DEPT CODE: COMPO2  |
| CANALE                       | 1942-01-01          | CONSULTANT<br>DEPT CODE: TECH03 |
| LAST PERSON SELECTED: CANALE |                     |                                 |

## DISPLAY Statement

The following example is referenced in the section *Page Titles, Page Breaks, Blank Lines*.

### DISPLX21 DISPLAY statement (with slash '/' and compare with WRITE)

```

** Example 'DISPLX21': DISPLAY (usage of slash '/' in DISPLAY and WRITE)
*****
DEFINE DATA LOCAL
1 EMPLOY-VIEW VIEW OF EMPLOYEES
  2 CITY
  2 NAME
  2 FIRST-NAME
  2 ADDRESS-LINE (1)
END-DEFINE
*
WRITE TITLE LEFT JUSTIFIED UNDERLINED
  *TIME
  5X 'PEOPLE LIVING IN SALT LAKE CITY'
  21X 'PAGE:' *PAGE-NUMBER /
  15X 'AS OF' *DAT4E //
*
WRITE TRAILER UNDERLINED 'REGISTER OF' / 'SALT LAKE CITY'
*
READ (2) EMPLOY-VIEW WITH CITY = 'SALT LAKE CITY'
  DISPLAY  NAME /
           FIRST-NAME
           'HOME/CITY' CITY
           'STREET/OR BOX NO.' ADDRESS-LINE (1)
  SKIP 1
END-READ
END
    
```

### Output of Program DISPLX21:

```

14:15:50.1    PEOPLE LIVING IN SALT LAKE CITY          PAGE:      1
              AS OF 13/12/2004

-----
              NAME                HOME                STREET
              FIRST-NAME          CITY              OR BOX NO.
-----
ANDERSON
JENNY                SALT LAKE CITY    3701 S. GEORGE MASON
    
```

```
SAMUELSON          SALT LAKE CITY      7610 W. 86TH STREET
MARTIN

                      REGISTER OF
                      SALT LAKE CITY
-----
```

## Column Headers

The following example is referenced in the section *Column Headers*.

### DISPLX15 - DISPLAY statement (with FC, UC)

```
** Example 'DISPLX15': DISPLAY (with FC, UC)
*****
DEFINE DATA LOCAL
1 EMPLOY-VIEW VIEW OF EMPLOYEES
  2 FIRST-NAME
  2 NAME
  2 ADDRESS-LINE (1)
  2 CITY
  2 TELEPHONE
  3 AREA-CODE
  3 PHONE
END-DEFINE
*
FORMAT AL=12 GC== UC=%
*
READ (3) EMPLOY-VIEW BY NAME STARTING FROM 'R'
  DISPLAY NOTITLE (FC=*)
    NAME FIRST-NAME CITY (FC=- UC=-) /
    ADDRESS-LINE(1) TELEPHONE
  SKIP 1
END-READ
END
```

### Output of Program DISPLX15:

```
****NAME**** *FIRST-NAME* ----CITY---- =====TELEPHONE=====
                      **ADDRESS**
                                ****AREA**** *TELEPHONE**
                                ****CODE****
%%%%%%%%%%%%% %%%%%%%%%%%%%% ----- %%%%%%%%%%%%%% %%%%%%%%%%%%%%
RACKMANN      MARIAN      FRANKFURT  069          375849
                      FINKENSTR. 1
```

```

RAMAMOORTHY  TY                SEPULVEDA  209          175-1885
                12018 BROOKS

RAMAMOORTHY  TIMMIE            SEATTLE   206          151-4673
                921-178TH PL
    
```

**DISPLX16 - DISPLAY statement (with '/', 'text', 'text/text')**

```

** Example 'DISPLX16': DISPLAY (with '/', 'text', 'text/text')
*****
DEFINE DATA LOCAL
1 EMPLOY-VIEW VIEW OF EMPLOYEES
  2 FIRST-NAME
  2 NAME
  2 ADDRESS-LINE (1)
  2 CITY
  2 TELEPHONE
    3 AREA-CODE
    3 PHONE
END-DEFINE
*
READ (5) EMPLOY-VIEW BY NAME STARTING FROM 'E'
  DISPLAY NOTITLE
    '/'          NAME          (AL=12) /* suppressed header
    'FIRST/NAME' FIRST-NAME (AL=10) /* two-line user-defined header
    'ADDRESS'    CITY /          /* user-defined header
    ' '          ADDRESS-LINE(1) /* 'blank' header
                TELEPHONE (HC=L) /* default header

  SKIP 1
END-READ
END
    
```

**Output of Program DISPLX16:**

|          | FIRST<br>NAME | ADDRESS                     | AREA<br>CODE | TELEPHONE |
|----------|---------------|-----------------------------|--------------|-----------|
| EAVES    | TREVOR        | DERBY<br>17 HARTON ROAD     | 0332         | 657623    |
| ECKERT   | KARL          | OBERRAMSTADT<br>FORSTWEG 22 | 06154        | 99722     |
| ECKHARDT | RICHARD       | DARMSTADT<br>BRESLAUERPL. 4 |              |           |



|           |         |                           |      |          |
|-----------|---------|---------------------------|------|----------|
| EDMUNDSON | LES     | TULSA<br>2415 ALSOP CT.   | 918  | 945-4916 |
| EGGERT    | HERMANN | STUTTGART<br>RABENGASSE 8 | 0711 | 981237   |

## Field-Output-Relevant Parameters

The following examples are referenced in the section *Parameters to Influence the Output of Fields*.

They are provided to demonstrate the use of the parameters LC, IC, TC, AL, NL, IS, ZP and ES, and the SUSPEND IDENTICAL SUPPRESS statement:

### DISPLX17 - DISPLAY statement (with NL, AL, IC, LC, TC)

```
** Example 'DISPLX17': DISPLAY (with NL, AL, IC, LC, TC)
*****
DEFINE DATA LOCAL
1 EMPLOY-VIEW VIEW OF EMPLOYEES
  2 FIRST-NAME
  2 NAME
  2 SALARY (1)
  2 BONUS (1,1)
END-DEFINE
*
READ (3) EMPLOY-VIEW BY NAME STARTING FROM 'JONES'
  DISPLAY NOTITLE (IS=ON NL=15)
      NAME
      '- ' '=' FIRST-NAME (AL=12)
      'ANNUAL SALARY' SALARY(1) (LC=USD TC=.00) /
      '+ BONUSSES' BONUS(1,1) (IC='+ ' TC=.00)
  SKIP 1
END-READ
END
```

### Output of Program DISPLX17:

| NAME  | FIRST-NAME | ANNUAL SALARY<br>+ BONUSSES |
|-------|------------|-----------------------------|
| JONES | - VIRGINIA | USD 46000.00<br>+ 9000.00   |
|       | - MARSHA   | USD 50000.00                |

|          |     |          |        |
|----------|-----|----------|--------|
|          |     |          | + 0.00 |
| - ROBERT | USD | 31000.00 |        |
|          |     |          | + 0.00 |

**DISPLX18 - DISPLAY statement (using default settings for SF, AL, UC, LC, IC, TC and compare with DISPLX19)**

```

** Example 'DISPLX18': DISPLAY (using default settings for SF, AL, UC,
**                          LC, IC, TC and compare with DISPLX19)
*****
DEFINE DATA LOCAL
1 EMPLOY-VIEW VIEW OF EMPLOYEES
  2 NAME
  2 FIRST-NAME
  2 CITY
  2 SALARY      (1)
  2 BONUS      (1,1)
END-DEFINE
*
FIND (6) EMPLOY-VIEW WITH CITY = 'CHAPEL HILL'
  DISPLAY NAME FIRST-NAME SALARY(1) BONUS(1,1)
END-FIND
END
    
```

**Output of Program DISPLX18:**

|       |          |            |                  |          |
|-------|----------|------------|------------------|----------|
| Page  | 1        |            | 04-12-13         | 14:20:48 |
|       | NAME     | FIRST-NAME | ANNUAL<br>SALARY | BONUS    |
| ----- |          |            |                  |          |
|       | KESSLER  | CLARE      | 41000            | 0        |
|       | ADKINSON | DAVID      | 24000            | 0        |
|       | GEE      | TOMMIE     | 39500            | 0        |
|       | HERZOG   | JOHN       | 31500            | 0        |
|       | QUILLION | TIMOTHY    | 30500            | 0        |
|       | CUMMINGS | PUALA      | 41000            | 1500     |

**DISPLX19 - DISPLAY statement (with SF, AL, LC, IC, TC and compare with DISPLX18)**

```

** Example 'DISPLX19': DISPLAY (with SF, AL, LC, IC, TC and compare
**                          with DISPLX19)
*****
DEFINE DATA LOCAL
1 EMPLOY-VIEW VIEW OF EMPLOYEES
  2 NAME
  2 FIRST-NAME
  2 CITY
  2 SALARY (1)
  2 BONUS (1,1)
END-DEFINE
*
FORMAT SF=3 AL=15 UC==
*
FIND (6) EMPLOY-VIEW WITH CITY = 'CHAPEL HILL'
  DISPLAY (NL=10)
    NAME
    FIRST-NAME (LC='- ' UC=-)
    SALARY (1) (LC=USD)
    BONUS (1,1) (IC='*** ' TC=' ***')
END-FIND
END

```

**Output of Program DISPLX19:**

```

Page      1                                04-12-13  14:21:57

      NAME                FIRST-NAME          ANNUAL          BONUS
      =====            - - - - -          =====            =====
KESSLER          - CLARE          USD          41000          *** 0 ***
ADKINSON         - DAVID          USD          24000          *** 0 ***
GEE              - TOMMIE         USD          39500          *** 0 ***
HERZOG           - JOHN           USD          31500          *** 0 ***
QUILLION         - TIMOTHY        USD          30500          *** 0 ***
CUMMINGS         - PUALA          USD          41000          *** 1500 ***

```

**SUSPEX01 - SUSPEND IDENTICAL SUPPRESS statement (in conjunction with parameters IS, ES, ZP in DISPLAY)**

```

** Example 'SUSPEX01': SUSPEND IDENTICAL SUPPRESS (in conjunction with
**                               parameters IS, ES, ZP in DISPLAY)
*****
DEFINE DATA LOCAL
1 EMPLOY-VIEW VIEW OF EMPLOYEES
  2 PERSONNEL-ID
  2 FIRST-NAME
  2 NAME
  2 CITY
1 VEH-VIEW VIEW OF VEHICLES
  2 PERSONNEL-ID
  2 MAKE
END-DEFINE
*
LIMIT 15
RD. READ EMPLOY-VIEW BY NAME STARTING FROM 'JONES'
  SUSPEND IDENTICAL SUPPRESS
  FD. FIND VEH-VIEW WITH PERSONNEL-ID = PERSONNEL-ID (RD.)
  IF NO RECORDS FOUND
    MOVE '*****' TO MAKE
  END-NOREC
  DISPLAY NOTITLE (ES=OFF IS=ON ZP=ON AL=15)
    NAME      (RD.)
    FIRST-NAME (RD.)
    MAKE      (FD.) (IS=OFF)
  END-FIND
END-READ
END

```

**Output of Program SUSPEX01:**

| NAME  | FIRST-NAME | MAKE           |
|-------|------------|----------------|
| JONES | VIRGINIA   | CHRYSLER       |
| JONES | MARSHA     | CHRYSLER       |
| JONES | ROBERT     | CHRYSLER       |
| JONES | LILLY      | GENERAL MOTORS |
| JONES | EDWARD     | FORD           |
| JONES | MARTHA     | MG             |
| JONES | LAUREL     | GENERAL MOTORS |
| JONES | KEVIN      | GENERAL MOTORS |
| JONES | GREGORY    | DATSUN         |
| JONES | MANFRED    | FORD           |
| JOPER | MANFRED    | *****          |

|           |         |         |
|-----------|---------|---------|
| JOUSSELIN | DANIEL  | RENAULT |
| JUBE      | GABRIEL | *****   |
| JUNG      | ERNST   | *****   |
| JUNKIN    | JEREMY  | *****   |
| KAISER    | REINER  | *****   |

**SUSPEX02 - SUSPEND IDENTICAL SUPPRESS statement (in conjunction with parameters IS, ES, ZP in DISPLAY) Identical to SUSPEX01, but with IS=OFF.**

```

** Example 'SUSPEX02': SUSPEND IDENTICAL SUPPRESS (in conjunction with
**                   parameters IS, ES, ZP in DISPLAY)
**                   Identical to SUSPEX01, but with IS=OFF.
*****
DEFINE DATA LOCAL
1 EMPLOY-VIEW VIEW OF EMPLOYEES
  2 PERSONNEL-ID
  2 FIRST-NAME
  2 NAME
  2 CITY
1 VEH-VIEW VIEW OF VEHICLES
  2 PERSONNEL-ID
  2 MAKE
END-DEFINE
*
LIMIT 15
RD. READ EMPLOY-VIEW BY NAME STARTING FROM 'JONES'
  SUSPEND IDENTICAL SUPPRESS
  FD. FIND VEH-VIEW WITH PERSONNEL-ID = PERSONNEL-ID (RD.)
    IF NO RECORDS FOUND
      MOVE '*****' TO MAKE
    END-NOREC
  DISPLAY NOTITLE (ES=OFF IS=OFF ZP=ON AL=15)
    NAME          (RD.)
    FIRST-NAME    (RD.)
    MAKE          (FD.) (IS=OFF)
  END-FIND
END-READ
END

```

**Output of Program SUSPEX02:**

| NAME  | FIRST-NAME | MAKE           |
|-------|------------|----------------|
| JONES | VIRGINIA   | CHRYSLER       |
| JONES | MARSHA     | CHRYSLER       |
| JONES | MARSHA     | CHRYSLER       |
| JONES | ROBERT     | GENERAL MOTORS |
| JONES | LILLY      | FORD           |

```

JONES          LILLY          MG
JONES          EDWARD        GENERAL MOTORS
JONES          MARTHA        GENERAL MOTORS
JONES          LAUREL        GENERAL MOTORS
JONES          KEVIN         DATSUN
JONES          GREGORY       FORD
JOPER         MANFRED        *****
JOUSSELIN     DANIEL          RENAULT
JUBE          GABRIEL        *****
JUNG          ERNST          *****
JUNKIN        JEREMY          *****
KAISER        REINER         *****
    
```

**COMPRX03 - COMPRESS statement**

```

** Example 'COMPRX03': COMPRESS (using parameters LC and TC)
*****
DEFINE DATA LOCAL
1 EMPLOY-VIEW VIEW OF EMPLOYEES
  2 CITY
  2 SALARY      (1)
  2 CURR-CODE  (1)
  2 LEAVE-DUE
  2 NAME
  2 FIRST-NAME
  2 JOB-TITLE
*
1 #SALARY      (N9)
1 #FULL-SALARY (A25)
1 #VACATION    (A11)
END-DEFINE
*
READ (3) EMPLOY-VIEW WITH CITY = 'BOSTON'
  MOVE SALARY(1) TO #SALARY
  COMPRESS 'SALARY :' CURR-CODE(1) #SALARY INTO #FULL-SALARY
  COMPRESS 'VACATION:' LEAVE-DUE          INTO #VACATION
/*
  DISPLAY NOTITLE NAME FIRST-NAME
           'JOB DESCRIPTION' JOB-TITLE (LC='JOB      : ') /
           '/'              #FULL-SALARY /
           '/'              #VACATION (TC='DAYS')

  SKIP 1
END-READ
END
    
```

Output of Program COMPRX03:



```

Page      1                                04-12-13  14:26:57

          N A M E                FIRST-NAME        CITY
          NAME HEX
-----
L  O  R  I  E                - JEAN-PAUL        * C..LEVELAND
D3 D6 D9 C9 C5 40 40 40 40 40
H  A  L  L                  - ARTHUR          * A..NN ARBER
C8 C1 D3 D3 40 40 40 40 40 40
V  A  S  W  A  N  I          - TOMMIE          * M..ONTERREY
E5 C1 E2 E6 C1 D5 C9 40 40 40 40
    
```

**EDITMX04 - Edit mask (different EM for numeric fields)**

```

** Example 'EDITMX04': Edit mask (different EM for numeric fields)
*****
DEFINE DATA LOCAL
1 EMPLOY-VIEW VIEW OF EMPLOYEES
  2 PERSONNEL-ID
  2 FIRST-NAME
  2 NAME
  2 SALARY (1)
  2 BONUS (1,1)
  2 LEAVE-DUE
END-DEFINE
*
LIMIT 2
READ EMPLOY-VIEW BY PERSONNEL-ID = '20018000'
      WHERE SALARY(1) = 28000 THRU 30000
  DISPLAY (SF=4)
    'N A M E'      NAME
    'SALARY'      SALARY(1) (EM=*USD^ZZZ,999)
    'BONUS (ZZ)'  BONUS(1,1) (EM=S*ZZZ,999) /
    'BONUS (Z9)' BONUS(1,1) (EM=SZ99,999+) /
    '->' '='      BONUS(1,1) (EM=-999,999)
    'VAC/DUE'    LEAVE-DUE (EM=+999)

  SKIP 1
END-READ
END
    
```

Output of Program EDITMX04:



```

Page      1                                04-12-13  14:27:43

      N A M E                SALARY          BONUS (ZZ)    VAC
                        BONUS (Z9)          DUE
                        BONUS
-----
LORIE                USD *28,000          +**4,000      +13
                        + 04,000+
                        -> 004,000

HALL                  USD *30,000          +**5,000      +14
                        + 05,000+
                        -> 005,000

```

### EDITMX05 - Edit mask (EM for date and time system variables)

```

** Example 'EDITMX05': Edit mask (EM for date and time system variables)
*****
WRITE NOTITLE //
  'DATE INTERNAL :' *DATX (DF=L) /
  '                :' *DATX (EM=N(9)' 'ZW.'WEEK 'YYYY) /
  '                :' *DATX (EM=ZZJ'.DAY 'YYYY) /
  '    ROMAN      :' *DATX (EM=R) /
  '    AMERICAN   :' *DATX (EM=MM/DD/YYYY)          12X 'OR ' *DAT4U /
  '    JULIAN     :' *DATX (EM=YYYYJJJ)            15X 'OR ' *DAT4J /
  '    GREGORIAN  :' *DATX (EM=ZD.'L(10)''YYYY) 5X 'OR ' *DATG ///
  'TIME INTERNAL :' *TIMX                          14X 'OR ' *TIME /
  '                :' *TIMX (EM=HH.II.SS.T) /
  '                :' *TIMX (EM=HH.II.SS' 'AP) /
  '                :' *TIMX (EM=HH)
END

```

### Output of Program EDITMX05:

```

DATE INTERNAL : 2004-12-13
                : Monday 51.WEEK 2004
                : 348.DAY 2004
    ROMAN      : MMIV
    AMERICAN   : 12/13/2004          OR 12/13/2004
    JULIAN     : 2004348             OR 2004348
    GREGORIAN  : 13.December2004    OR 13December 2004

TIME INTERNAL : 14:28:49            OR 14:28:49.1
                : 14.28.49.1

```

```
: 02.28.49 PM
: 14
```

## DISPLAY VERT with WRITE Statement

### WRITEX10 - WRITE statement (with nT, T\*field and P\*field)

```
** Example 'WRITEX10': WRITE (with nT, T*field and P*field)
*****
DEFINE DATA LOCAL
1 EMPLOY-VIEW VIEW OF EMPLOYEES
  2 JOB-TITLE
  2 NAME
  2 SALARY (1)
  2 BONUS (1,1)
END-DEFINE
*
READ (3) EMPLOY-VIEW WITH JOB-TITLE FROM 'SALES PERSON'
  DISPLAY NOTITLE NAME 30T JOB-TITLE
    VERT AS 'SALARY/BONUS' SALARY(1) BONUS(1,1)
  AT BREAK OF JOB-TITLE
    WRITE 20T 'AVERAGE' T*JOB-TITLE OLD(JOB-TITLE) (AL=15)
      '(SAL)' P*SALARY AVER(SALARY(1)) /
    46T '(BON)' P*BONUS AVER(BONUS(1,1)) /
  END-BREAK
  SKIP 1
END-READ
END
```

### Output of Program WRITEX10:

| NAME           | CURRENT POSITION | SALARY | BONUS |
|----------------|------------------|--------|-------|
| SAMUELSON      | SALES PERSON     | 32000  | 6000  |
| PAPAYANOPOULOS | SALES PERSON     | 34000  | 7000  |
| HELL           | SALES PERSON     | 38000  | 9000  |
| AVERAGE        | SALES PERSON     | (SAL)  | 34666 |
|                |                  | (BON)  | 7333  |

## AT BREAK Statement

The following example is referenced in the section *Control Breaks*.

### ATBEX06 - AT BREAK OF statement (comparing NMIN, NAVER, NCOUNT with MIN, AVER, COUNT)

```

** Example 'ATBEX06': AT BREAK OF (comparing NMIN, NAVER, NCOUNT with
**                               MIN, AVER, COUNT)
*****
DEFINE DATA LOCAL
1 EMPLOY-VIEW VIEW OF EMPLOYEES
  2 CITY
  2 SALARY (1:2)
END-DEFINE
*
WRITE TITLE '-- SALARY STATISTICS BY CITY --' /
*
READ (2) EMPLOY-VIEW WITH CITY = 'NEW YORK'
  DISPLAY CITY 'SALARY (1)' SALARY(1) 15X 'SALARY (2)' SALARY(2)
  AT BREAK OF CITY
    WRITE /
      14T 'S A L A R Y   (1)'           39T 'S A L A R Y   (2)'           /
      13T '-   MIN:' MIN(SALARY(1))    38T '-   MIN:' MIN(SALARY(2))    /
      13T '-   AVER:' AVER(SALARY(1))  38T '-   AVER:' AVER(SALARY(2))  /
      16T COUNT(SALARY(1)) 'RECORDS'  41T COUNT(SALARY(2)) 'RECORDS' //
      13T '-   NMIN:' NMIN(SALARY(1)) 38T '-   NMIN:' NMIN(SALARY(2)) /
      13T '-   NAVER:' NAVER(SALARY(1))38T '-   NAVER:' NAVER(SALARY(2)) /
      16T NCOUNT(SALARY(1)) 'RECORDS'41T NCOUNT(SALARY(2)) 'RECORDS'
  END-BREAK
END-READ
END

```

#### Output of Program ATBEX06:

```

                -- SALARY STATISTICS BY CITY --
CITY           SALARY (1)           SALARY (2)
-----
NEW YORK           17000                16100
NEW YORK           38000                34900

      S A L A R Y   (1)           S A L A R Y   (2)
-   MIN:           17000           -   MIN:           16100
-   AVER:           27500           -   AVER:           25500
      2 RECORDS                2 RECORDS

```

```

- NMIN:      17000      - NMIN:      16100
- NAVER:     27500      - NAVER:     25500
                2 RECORDS                2 RECORDS

```

## COMPUTE, MOVE and COMPRESS Statements

The following examples are referenced in the section *Data Computation*.

### WRITEX11 - WRITE statement (with nX, n/n and COMPRESS)

```

** Example 'WRITEX11': WRITE (with nX, n/n and COMPRESS)
*****
DEFINE DATA LOCAL
1 EMPLOY-VIEW VIEW OF EMPLOYEES
  2 PERSONNEL-ID
  2 SALARY      (1)
  2 FIRST-NAME
  2 NAME
  2 CITY
  2 ZIP
  2 CURR-CODE  (1)
  2 JOB-TITLE
  2 LEAVE-DUE
  2 ADDRESS-LINE (1)
*
1 #SALARY      (A8)
1 #FULL-NAME   (A25)
1 #FULL-CITY   (A25)
1 #FULL-SALARY (A25)
1 #VACATION    (A16)
END-DEFINE
*
READ (3) EMPLOY-VIEW LOGICAL BY PERSONNEL-ID = '2001800'
  MOVE SALARY(1) TO #SALARY
  COMPRESS FIRST-NAME NAME           INTO #FULL-NAME
  COMPRESS ZIP      CITY             INTO #FULL-CITY
  COMPRESS 'SALARY :' CURR-CODE(1) #SALARY INTO #FULL-SALARY
  COMPRESS 'VACATION:' LEAVE-DUE 'DAYS' INTO #VACATION
/*
  DISPLAY NOTITLE 'NAME AND ADDRESS' NAME
                5X 'PERS-NO.'      PERSONNEL-ID
                3X 'JOB TITLE'     JOB-TITLE (LC='JOB      : ')
WRITE  1/5 #FULL-NAME      1/37 #FULL-SALARY
      2/5 ADDRESS-LINE(1)  2/37 #VACATION
      3/5 #FULL-CITY
SKIP 1

```

```
END-READ
END
```

### Output of Program WRITEX11:

| NAME AND ADDRESS                                                   | PERS-NO. | JOB TITLE                                                  |
|--------------------------------------------------------------------|----------|------------------------------------------------------------|
| FARRIS<br>JACKIE FARRIS<br>918 ELM STREET<br>32306 TALLAHASSEE     | 20018000 | JOB : PROGRAMMER<br>SALARY : USD 30500<br>VACATION: 10 DAY |
| EVANS<br>JO EVANS<br>1058 REDSTONE LANE<br>68508 LINCOLN           | 20018100 | JOB : PROGRAMMER<br>SALARY : USD 31000<br>VACATION: 11 DAY |
| HERZOG<br>JOHN HERZOG<br>255 ZANG STREET #253<br>27514 CHAPEL HILL | 20018200 | JOB : PROGRAMMER<br>SALARY : USD 31500<br>VACATION: 12 DAY |

### IFX03 - IF statement

```
** Example 'IFX03': IF
*****
DEFINE DATA LOCAL
1 EMPLOY-VIEW VIEW OF EMPLOYEES
  2 NAME
  2 CITY
  2 BONUS (1,1)
  2 SALARY (1)
*
1 #INCOME (N9)
1 #TEXT (A26)
END-DEFINE
*
WRITE TITLE '-- DISTRIBUTION OF CATALOGS I AND II --' /
*
READ (3) EMPLOY-VIEW BY CITY = 'SAN FRANCISCO'
  COMPUTE #INCOME = BONUS(1,1) + SALARY(1)
  /*
  IF #INCOME > 40000
    MOVE 'CATALOGS I AND II' TO #TEXT
  ELSE
    MOVE 'CATALOG I' TO #TEXT
  END-IF
  /*
```

## Referenced Example Programs

```
DISPLAY NAME 5X 'SALARY' SALARY(1) / BONUS(1,1)
WRITE T*SALARY '-'(10) /
      16X 'INCOME:' T*SALARY #INCOME 3X #TEXT /
      16X '='(19)
SKIP 1
END-READ
END
```

### Output of Program IFX03:

```
          -- DISTRIBUTION OF CATALOGS I AND II --
NAME                SALARY
                   BONUS
-----
COLVILLE JR        56000
                   0
                   -----
                   INCOME: 56000 CATALOGS I AND II
                   =====
RICHMOND            9150
                   0
                   -----
                   INCOME: 9150 CATALOG I
                   =====
MONKTON             13500
                   600
                   -----
                   INCOME: 14100 CATALOG I
                   =====
```

### COMPRX03 - COMPRESS statement (using parameters LC and TC)

```
** Example 'COMPRX03': COMPRESS (using parameters LC and TC)
*****
DEFINE DATA LOCAL
1 EMPLOY-VIEW VIEW OF EMPLOYEES
  2 CITY
  2 SALARY      (1)
  2 CURR-CODE  (1)
  2 LEAVE-DUE
  2 NAME
  2 FIRST-NAME
  2 JOB-TITLE
*
1 #SALARY      (N9)
```

```

1 #FULL-SALARY (A25)
1 #VACATION    (A11)
END-DEFINE
*
READ (3) EMPLOY-VIEW WITH CITY = 'BOSTON'
  MOVE SALARY(1) TO #SALARY
  COMPRESS 'SALARY  :' CURR-CODE(1) #SALARY INTO #FULL-SALARY
  COMPRESS 'VACATION:' LEAVE-DUE      INTO #VACATION
  /*
  DISPLAY NOTITLE NAME FIRST-NAME
           'JOB DESCRIPTION' JOB-TITLE (LC='JOB      : ') /
           '/'              #FULL-SALARY /
           '/'              #VACATION (TC='DAYS')
  SKIP 1
END-READ
END

```

Output of Program COMPRX03:

| NAME     | FIRST-NAME | JOB DESCRIPTION                                                  |
|----------|------------|------------------------------------------------------------------|
| SHAW     | LESLIE     | JOB      : SECRETARY<br>SALARY   : USD 18000<br>VACATION: 2DAYS  |
| STANWOOD | VERNON     | JOB      : PROGRAMMER<br>SALARY   : USD 31000<br>VACATION: 1DAYS |
| CREMER   | WALT       | JOB      : SECRETARY<br>SALARY   : USD 20000<br>VACATION: 3DAYS  |

## System Variables

The following examples are referenced in the section *System Variables and System Functions*.

**EDITMX05 - Edit mask (EM for date and time system variables)**

```

** Example 'EDITMX05': Edit mask (EM for date and time system variables)
*****
WRITE NOTITLE //
  'DATE INTERNAL : ' *DATX (DF=L) /
  '               : ' *DATX (EM=N(9)' 'ZW.'WEEK 'YYYY) /
  '               : ' *DATX (EM=ZZJ'.DAY 'YYYY) /
  '   ROMAN      : ' *DATX (EM=R) /
  '   AMERICAN   : ' *DATX (EM=MM/DD/YYYY)      12X 'OR ' *DAT4U /
  '   JULIAN     : ' *DATX (EM=YYYYJJJ)        15X 'OR ' *DAT4J /
  '   GREGORIAN : ' *DATX (EM=ZD.'L(10)''YYYY) 5X 'OR ' *DATG ///
  'TIME INTERNAL : ' *TIMX                      14X 'OR ' *TIME /
  '               : ' *TIMX (EM=HH.II.SS.T) /
  '               : ' *TIMX (EM=HH.II.SS' 'AP) /
  '               : ' *TIMX (EM=HH)
END

```

**Output of Program EDITMX05:**

```

DATE INTERNAL : 2004-12-13
               : Monday 51.WEEK 2004
               : 348.DAY 2004
   ROMAN      : MMIV
   AMERICAN   : 12/13/2004      OR   12/13/2004
   JULIAN     : 2004348         OR   2004348
   GREGORIAN  : 13.December2004 OR   13December 2004

TIME INTERNAL : 14:36:58      OR   14:36:58.8
               : 14.36.58.8
               : 02.36.58 PM
               : 14

```

**READX04 - READ statement (in combination with FIND and the system variables \*NUMBER and \*COUNTER)**

```

** Example 'READX04': READ (in combination with FIND and the system
**                       variables *NUMBER and *COUNTER)
*****
DEFINE DATA LOCAL
1 EMPLOY-VIEW VIEW OF EMPLOYEES
  2 PERSONNEL-ID
  2 NAME
  2 FIRST-NAME
1 VEHIC-VIEW VIEW OF VEHICLES

```



```

2 PERSONNEL-ID
2 MAKE
END-DEFINE
*
LIMIT 10
RD. READ EMPLOY-VIEW BY NAME STARTING FROM 'JONES'
  FD. FIND VEHIC-VIEW WITH PERSONNEL-ID = PERSONNEL-ID (RD.)
  IF NO RECORDS FOUND
    ENTER
  END-NOREC
/*
  DISPLAY NOTITLE
    *COUNTER (RD.)(NL=8) NAME          (AL=15) FIRST-NAME (AL=10)
    *NUMBER (FD.)(NL=8) *COUNTER (FD.)(NL=8) MAKE
  END-FIND
END-READ
END

```

#### Output of Program READX04:

| CNT | NAME  | FIRST-NAME | NMBR | CNT | MAKE           |
|-----|-------|------------|------|-----|----------------|
| 1   | JONES | VIRGINIA   | 1    | 1   | CHRYSLER       |
| 2   | JONES | MARSHA     | 2    | 1   | CHRYSLER       |
| 2   | JONES | MARSHA     | 2    | 2   | CHRYSLER       |
| 3   | JONES | ROBERT     | 1    | 1   | GENERAL MOTORS |
| 4   | JONES | LILLY      | 2    | 1   | FORD           |
| 4   | JONES | LILLY      | 2    | 2   | MG             |
| 5   | JONES | EDWARD     | 1    | 1   | GENERAL MOTORS |
| 6   | JONES | MARTHA     | 1    | 1   | GENERAL MOTORS |
| 7   | JONES | LAUREL     | 1    | 1   | GENERAL MOTORS |
| 8   | JONES | KEVIN      | 1    | 1   | DATSUN         |
| 9   | JONES | GREGORY    | 1    | 1   | FORD           |
| 10  | JOPER | MANFRED    | 0    | 0   |                |

#### WTITLX01 - WRITE TITLE statement (with \*PAGE-NUMBER)

```

** Example 'WTITLX01': WRITE TITLE (with *PAGE-NUMBER)
*****
DEFINE DATA LOCAL
1 VEHIC-VIEW VIEW OF VEHICLES
  2 MAKE
  2 YEAR
  2 MAINT-COST (1)
END-DEFINE
*
LIMIT 5
*

```

```

READ VEHIC-VIEW
END-ALL
SORT BY YEAR USING MAKE MAINT-COST (1)
  DISPLAY NOTITLE YEAR MAKE MAINT-COST (1)
  AT BREAK OF YEAR
    MOVE 1 TO *PAGE-NUMBER
    NEWPAGE
  END-BREAK
/*
  WRITE TITLE LEFT JUSTIFIED
    'YEAR:' YEAR 15X 'PAGE' *PAGE-NUMBER
END-SORT
END

```

Output of Program WTITLX01:

| YEAR: | 1980    | PAGE       | 1 |
|-------|---------|------------|---|
| YEAR  | MAKE    | MAINT-COST |   |
| ----- |         |            |   |
| 1980  | RENAULT | 20000      |   |
| 1980  | RENAULT | 20000      |   |
| 1980  | PEUGEOT | 20000      |   |

## System Functions

---

The following examples are referenced in the section *System Variables and System Functions*.

### ATBREX06 - AT BREAK OF statement (comparing NMIN, NAVER, NCOUNT with MIN, AVER, COUNT)

```

** Example 'ATBREX06': AT BREAK OF (comparing NMIN, NAVER, NCOUNT with
**                               MIN, AVER, COUNT)
*****
DEFINE DATA LOCAL
1 EMPLOY-VIEW VIEW OF EMPLOYEES
  2 CITY
  2 SALARY (1:2)
END-DEFINE
*
WRITE TITLE '-- SALARY STATISTICS BY CITY --' /
*
READ (2) EMPLOY-VIEW WITH CITY = 'NEW YORK'
  DISPLAY CITY 'SALARY (1)' SALARY(1) 15X 'SALARY (2)' SALARY(2)
  AT BREAK OF CITY
  WRITE /

```

```

14T 'S A L A R Y   (1)'           39T 'S A L A R Y   (2)'           /
13T '-   MIN:' MIN(SALARY(1))    38T '-   MIN:' MIN(SALARY(2))    /
13T '-   AVER:' AVER(SALARY(1))  38T '-   AVER:' AVER(SALARY(2)) /
16T COUNT(SALARY(1)) 'RECORDS'  41T COUNT(SALARY(2)) 'RECORDS' //
13T '-   NMIN:' NMIN(SALARY(1)) 38T '-   NMIN:' NMIN(SALARY(2)) /
13T '-   NAVER:' NAVER(SALARY(1)) 38T '-   NAVER:' NAVER(SALARY(2)) /
16T NCOUNT(SALARY(1)) 'RECORDS' 41T NCOUNT(SALARY(2)) 'RECORDS'
END-BREAK
END-READ
END

```

### Output of Program ATBREX06:

```

-- SALARY STATISTICS BY CITY --

```

| CITY     | SALARY (1) | SALARY (2) |
|----------|------------|------------|
| NEW YORK | 17000      | 16100      |
| NEW YORK | 38000      | 34900      |

```

S A L A R Y   (1)           S A L A R Y   (2)
-   MIN:      17000         -   MIN:      16100
-   AVER:      27500         -   AVER:      25500
      2 RECORDS              2 RECORDS

-   NMIN:      17000         -   NMIN:      16100
-   NAVER:      27500         -   NAVER:      25500
      2 RECORDS              2 RECORDS

```

### ATENPX01 - AT END OF PAGE statement (with system function available via GIVE SYSTEM FUNCTIONS in DISPLAY)

```

** Example 'ATENPX01': AT END OF PAGE (with system function available
**                               via GIVE SYSTEM FUNCTIONS in DISPLAY)
*****
DEFINE DATA LOCAL
1 EMPLOY-VIEW VIEW OF EMPLOYEES
  2 PERSONNEL-ID
  2 NAME
  2 JOB-TITLE
  2 SALARY (1)
END-DEFINE
*
READ (10) EMPLOY-VIEW BY PERSONNEL-ID = '20017000'
  DISPLAY NOTITLE GIVE SYSTEM FUNCTIONS
    NAME JOB-TITLE 'SALARY' SALARY(1)
/*
AT END OF PAGE

```

## Referenced Example Programs

---

```
WRITE / 24T 'AVERAGE SALARY: ...' AVER(SALARY(1))
END-ENDPAGE
END-READ
END
```

### Output of Program ATENPX01:

| NAME    | CURRENT<br>POSITION | SALARY |
|---------|---------------------|--------|
| CREMER  | ANALYST             | 34000  |
| MARKUSH | TRAINEE             | 22000  |
| GEE     | MANAGER             | 39500  |
| KUNEY   | DBA                 | 40200  |
| NEEDHAM | PROGRAMMER          | 32500  |
| JACKSON | PROGRAMMER          | 33000  |
| PIETSCH | SECRETARY           | 22000  |
| PAUL    | SECRETARY           | 23000  |
| HERZOG  | MANAGER             | 48500  |
| DEKKER  | DBA                 | 48000  |
|         | AVERAGE SALARY: ... | 34270  |