



Audit Management Conventions Manual

ARIS Risk & Compliance Manager
Version 9.8 - Service Release 1

June 2015

This document applies to ARIS Risk & Compliance Manager Version 9.8 and to all subsequent releases. Specifications contained herein are subject to change and these changes will be reported in subsequent release notes or new editions.

Copyright © 2000 - 2015 [Software AG](#), Darmstadt, Germany and/or Software AG USA Inc., Reston, VA, USA, and/or its subsidiaries and/or its affiliates and/or their licensors.

The name Software AG and all Software AG product names are either trademarks or registered trademarks of Software AG and/or Software AG USA Inc. and/or its subsidiaries and/or its affiliates and/or their licensors. Other company and product names mentioned herein may be trademarks of their respective owners. Detailed information on trademarks and patents owned by Software AG and/or its subsidiaries is located at <http://softwareag.com/licenses>.

Use of this software is subject to adherence to Software AG's licensing conditions and terms. These terms are part of the product documentation, located at <http://softwareag.com/licenses> and/or in the root installation directory of the licensed product(s).

This software may include portions of third-party products. For third-party copyright notices, license terms, additional rights or restrictions, please refer to "License Texts, Copyright Notices and Disclaimers of Third Party Products". For certain specific third-party license restrictions, please refer to section E of the Legal Notices available under "License Terms and Conditions for Use of Software AG Products / Copyright and Trademark Notices of Software AG Products". These documents are part of the product documentation, located at <http://softwareag.com/licenses> and/or in the root installation directory of the licensed product(s).



Contents

1	Introduction	1
2	Text conventions.....	2
3	Content of document	3
3.1	Objectives and scope	3
4	ARIS conventions.....	4
4.1	Create users and user groups.....	4
4.1.1	Role to person allocations	6
4.2	Generate audit templates	8
4.2.1	Audits overview	8
4.2.2	Audit step overview.....	11
4.2.3	Definition of the scope	14
4.3	Deactivation of objects and connections	16



1 Introduction

In order to simplify the creation of audit templates and facilitate reusability you can model objects with an audit template in ARIS Architect (ABA). This is however only possible if the methodological and functional rules and conventions for modeling in ARIS Architect are adhered to. Only then can all modeled data be transferred to ARIS Risk & Compliance Manager (ARCM) and reused there.



2 Text conventions

Menu items, file names, etc. are indicated in texts as follows:

- Menu items, keyboard shortcuts, dialogs, file names, entries, etc. are shown in **bold**.
- Content input that you specify is shown in **<bold and within angle brackets>**.
- Single-line example texts are separated at the end of a line by the character ↵, e.g., a long directory path that comprises multiple lines.
- File extracts are shown in the following font:

`This paragraph contains a file extract.`



3 Content of document

The sections below explain the standards relating to the use of descriptive views, model types, object types, relationship and connection types, and attributes.

3.1 Objectives and scope

Objective: Specification of modeling guidelines

Not included in this manual: User documentation



4 ARIS conventions

4.1 Create users and user groups

Users and user groups are modeled in an organizational chart in ARIS Architect using the **Person** (OT_PERS) and **Role** (OT_PERS_TYPE) objects.

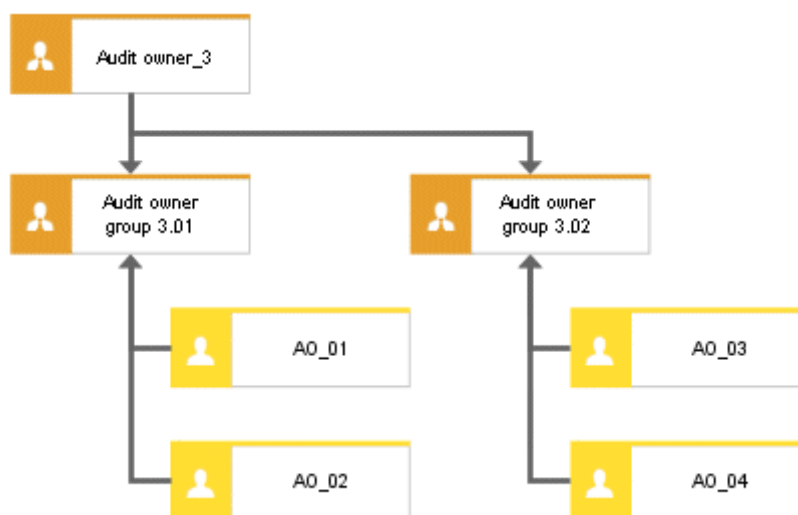

Figure 1: Structure of users/user groups (organizational chart)

The superior role **Audit owner_3** determines the roles held by the subordinate roles in ARIS Risk & Compliance Manager. Both roles are connected to one another with the **is generalization of** connection. Thus, **Audit owner group 3.01** is the generalization of **Audit owner_3**. The name of the superior role defines the role and level of the group to be created. <Role>_<Level>, i. e. Audit owner_3 > Role: Audit owner, Level: 3 (or object-specific). A user group is not generated in ARIS Risk & Compliance Manager for the superior role (**Audit owner_3**).

The following applies for the various levels:

- Level 1: cross-client
Means that the privileges are assigned across clients.
- Level 2: client-specific
Means that the privileges are assigned for a particular client.
- Level 3: object-specific
Means that the privileges are assigned for a particular object, e.g. policy, risk or control.

For the above example, the **Audit owner group 3.01** user group is generated in ARIS Risk & Compliance Manager with the **Audit owner** role and the level 3 (i.e. with object-specific privileges). In addition, the users with the user IDs **AO_01** and **AO_02** are also generated.



Mapping Role name (ARCM) to Role (ABA)

The following allocations are applicable for the user groups in ARIS Risk & Compliance Manager and the naming to be used in ARIS Architect. Further roles are described in the other conventions manuals.

Role (ARCM)	Role (ABA)	Notes
roles.auditauditor	Audit auditor	Levels 1, 2, and 3
roles.auditmanager	Audit manager	Levels 1 and 2
roles.auditowner	Audit owner	Level 3 only
roles.auditreviewer	Audit reviewer	Level 3 only
roles.auditstepowner	Audit step owner	Level 3 only



4.1.1 Role to person allocations

Role (ABA) to User group (ARCM) allocations

The following allocations are applicable for the **Role** (user group) object:

ABA attribute	API name	ARCM attribute	M*	Notes
Name	AT_NAME	name	X	The name of a user group is limited to 250 characters.
Description/ Definition	AT_DESC	description	-	
Role	–	role	X	The values for Role and Role level are determined as described above.
Role level	–	rolelevel	X	
Users	–	groupmembers	-	Users are determined by the performs connection between the person and the role.

*The **M** column specifies whether the attribute is a mandatory field.



Person (ABA) to User (ARCM) allocations

Existing databases based on old modeling conventions can be migrated using the report **ARCM user migration.arx** supplied. Since the two attributes for first and last name are derived from the same attribute the result needs to be verified.

The following allocations are applicable for the **Person** (user) object:

ABA attribute	API name	ARCM attribute	M*	Notes
Login	AT_LOGIN	Userid	X	The user ID of of a user is limited to 250 characters.
First name	AT_FIRST_NAME	firstname	X	
Last name	AT_LAST_NAME	lastname	X	
		name	-	Is a combination of the last and first name
Description/ Definition	AT_DESC	description	-	
E-mail address	AT_EMAIL_ADDR	email	X	
Telephone number	AT_PHONE_NUM	phone	-	
		clients	-	The clients field is determined by the client into which data is imported.
		substitutes	-	The substitutes field is only maintained manually.

*The **M** column specifies whether the attribute is a mandatory field.



4.2 Generate audit templates

4.2.1 Audits overview

You can model audit templates in ARIS Architect to simplify master data maintenance. The **Project schedule** (MT_PROJECT_SCHEDULE) model is intended for this.

4.2.1.1 Model properties

To use attribute-based modeling you must specify the row/column properties for attribute-based modeling. Right-click the column header, select **Properties > Format > Attribute-based modeling** and edit the following items:



Position attribute: **Start date** (AT_DATE_START)

Dimension attribute: **Max. total time** (AT_MAX_TL_TIME)

Attribute-dependent symbols: Position and dimension must be allowed for the **Task** object.

4.2.1.2 Objects, relationships and attributes

You can use the following objects in the **Project plan** model:

Object type name	Symbol type name	API name	Symbols	ARCM name
Task	Project	OT_FUNC_INST		Audit template
Role	Role	OT_PERS_TYPE		Audit owner, Audit reviewer, Audit auditor (depending on the role selected)

The following connections may be used:

Object	Connection	Object	Remark
Task (project)	is carried out by	Role	The implicit connection to the task is generated automatically if you model the organizational unit in the first column (organizational elements).



4.2.1.2.1 Objects, relationships and attributes

The following allocations are applicable for the **Task** (project) object:

ABA attribute	API name	ARCM attribute	M*	Notes
Name	AT_NAME	name	X	Limited to 250 characters.
Description	AT_DESC	description		
Start date	AT_DATE_START	auditstartdate	X	Start date of the audit. Everyone involved is informed about their tasks.
	-	auditenddate		Is calculated using the start date plus the max. total time
Max. total time	AT_MAX_TL_TIME	-	X	
Weekend off	AT_WEEKEND_OFF	-		If the Weekend off option was selected the max. total time is extended by two days when the time period contains a weekend.
Audit client	AT_AUDIT_CLIENT	audit_client	X	Organization or person the audit was requested by.
Export relevant	AT_AAM_EXPORT_RELEVANT	-		This attribute specifies whether an audit template should be exported to ARCM.
Audit objective	AT_AUDIT_OBJECTIVE	objectives		Definition of the audit objective.
Start date of the audit preparation	AT_START_DATE_OF_AUDIT_PREPARATION	plannedstartdate	X	Start of the preparatory phase. The audit is generated.



ABA attribute	API name	ARCM attribute	M*	Notes
Start date of control period	AT_START_DATE_OF_CONTROL_PERIOD	controlstartdate	X	Start date of the control period to be audited.
End date of control period	AT_END_DATE_OF_CONTROL_PERIOD	controlenddate	X	End date of the control period to be audited.
Title 1/Link 1 Title 2/Link 2 Title 3/Link 3 Title 4/Link 4	AT_TITL1/AT_EXT_1 AT_TITL2/AT_EXT_2 AT_TITL3/AT_EXT_3 AT_TITL4/AT_EXT_4	documents		
ARIS Document Storage link 1 ARIS Document Storage link 2 ARIS Document Storage link 3 ARIS Document Storage link 4	AT_ADS_LINK_1 AT_ADS_LINK_2 AT_ADS_LINK_3 AT_ADS_LINK_4	documents		

*The **M** column specifies whether the attribute is a mandatory field.



4.2.2 Audit step overview

You can assign a model of the **Project schedule** type (MT_PROJECT_SCHEDULE) to the audit template (Task (project)) to define the audit template steps of an audit template.

4.2.2.1 Model properties

To use attribute-based modeling you must specify the row/column properties for attribute-based modeling. Right-click the column header, select **Properties > Format > Attribute-based modeling** and edit the following items:

Position attribute: **Start date** (AT_DATE_START)



Dimension attribute: **Max. total time** (AT_MAX_TL_TIME)

Attribute-dependent symbols: Position and dimension must be allowed for the **Task** object.

4.2.2.2 Objects, relationships and attributes

Objects and names (audit steps)

You can use the following objects in the **Project plan** model:

Object type name	Symbol type name	API name	Symbols	ARCM name
Task	Task	OT_FUNC_INST		Audit step template
Role	Role	OT_PERS_TYPE		Audit step owner

Connections (audit steps)

The following connections may be used:

Object	Connection	Object	Remark
Task (task)	is carried out by	Role	The implicit connection to the task is generated automatically if you model the organizational unit in the first column (organizational elements).
Task (task)	belongs to	Task (task)	Defines which task is superior.



4.2.2.2.1 Task (ABA) to Audit step template (ARCM) allocations

The following allocations are applicable for the **Task** (task) object:

ABA attribute	API name	ARCM attribute	M*	Notes
Name	AT_NAME	name	X	Limited to 250 characters.
Description	AT_DESC	description		
Start date	AT_DATE_START	plannedstartdate	X	Planned start date of the audit step.
	-	plannedenddate		Is calculated using the start date plus the max. total time
Max. total time	AT_MAX_TL_TIME	-	X	
Weekend off	AT_WEEKEND_OFF	-		If the Weekend off option was selected the max. total time is extended by two days when the time period contains a weekend.
Required processing time	AT_DES_PROC_TIME	processingtime	X	Duration planned for the execution of the audit step



ABA attribute	API name	ARCM attribute	M*	Notes
ARIS Document Storage link 1	AT_ADS_LINK_1	documents		
ARIS Document Storage link 2	AT_ADS_LINK_2			
ARIS Document Storage link 3	AT_ADS_LINK_3			
ARIS Document Storage link 4	AT_ADS_LINK_4			

*The **M** column specifies whether the attribute is a mandatory field.







4.2.3 Definition of the scope



To define the scope of an audit or an audit step, you can use the **Task allocation diagram** (MT_FUNC_ALLOC_DGM_INST). Depending on the selected scope, associated elements such as test cases, risk assessments etc. (filtered according to the defined control period) are displayed for the assigned audit/audit step in ARCM.

Objects and names (scope)

The following objects can be used in a **task allocation diagram**:

Object type name	Symbol type name	API name	Symbols	ARCM name
Task	Project/Task	OT_FUNC_INST	 	Audit/Audit step
Risk category	Risk category	OT_RISK_CATEGORY		Risk category
Application system type	Application system type	OT_APPL_SYS_TYPE		Application system types



Object type name	Symbol type name	API name	Symbols	ARCM name
Function	Function	OT_FUNC		Process
Organizational unit	Organizational unit	OT_ORG_UNIT		Organization
Technical term	Technical term	OT_TECH_TRM		Regulations

The following connections may be used:

Object	Connection	Object
Risk category	is within the scope of	Task
Application system type	is within the scope of	Task
Function	is within the scope of	Task
Organizational unit	is within the scope of	Task
Technical term	is within the scope of	Task

No more than one connection of the **is within the scope of** type is allowed per audit/audit step.



4.3 Deactivation of objects and connections

The objects and relationships in ARIS Risk & Compliance Manager are subject to versioning to ensure traceability of changes. Therefore, objects and relationships in ARIS Risk & Compliance Manager are deactivated and not deleted. This means that the corresponding data items are not removed from the database, but rather marked as deactivated.

To deactivate objects/relationships in ARIS Risk & Compliance Manager via an import you must mark them accordingly in ARIS Architect. To do so, you use the attribute **Deactivated** (AT_DEACT). The attribute can be set for both objects and connections. As soon as the attribute is set, the object or connection will be deactivated upon the next import.

To deactivate an audit step, the connection to the superior object, as well as the audit step itself must be marked as deactivated.

Of course, this is only the case if the objects/relationships are included in the ARIS Architect export file. After the successful import into ARIS Risk & Compliance Manager you can delete the objects/connections in ARIS Architect. If objects/relationships were deleted in ARIS Architect before a deactivation import took place you can deactivate them manually in ARIS Risk & Compliance Manager.