



# ARIS 10 SR6 FEATURES OVERVIEW

ARIS Product Marketing  
September 2018

# ARIS 10 SR6 HIGHLIGHTS

---

**LARGE  
ENTERPRISE  
SCENARIOS**

**END-USER  
EXPERIENCE**

---

**BUSINESS & IT  
ALIGNMENT**

**PROCESS  
MINING**

**GDPR  
COMPLIANCE**

# LARGE ENTERPRISE SCENARIOS



# ARIS SUPPORT FOR LARGE ENTERPRISE SCENARIOS

## CONFIGURATION, USER & LICENSE MANAGEMENT



- 1 The new ARIS License Monitoring<sup>1</sup>** allows to track actual usage of licenses and to check proper license allocation
- 2 SAML Single-Sign-On support with ARIS Architect/Designer**  
Users of rich-clients do not need to double authenticate anymore
- 3 Simplified backup of portal configuration**  
Portal configurations are now considered in backup/restore procedures

Ease of operations

Business & technical  
administrators

# ARIS SUPPORT FOR LARGE ENTERPRISE SCENARIOS

## CONFIGURATION, USER & LICENSE MANAGEMENT

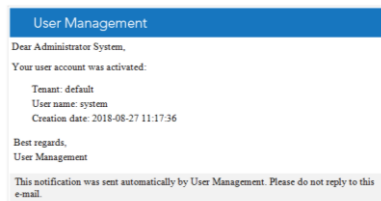
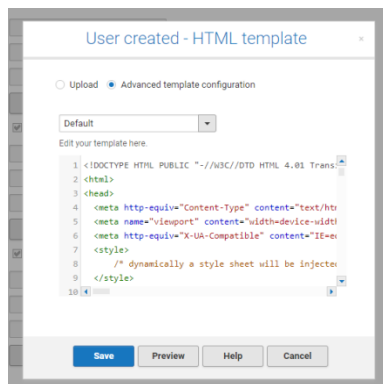
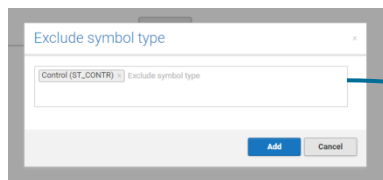

User notification

- 1 Symbols in Steps view SSC**  
Users can now filter the Steps view to exclude symbols (e.g. controls)
- 2 UMC notifications in tenant backup**  
Custom UMC notifications are now considered in the tenant backup/restore

Ease of operations

Business & technical administrators

# ENTERPRISE MANAGEMENT SYSTEMS

- **Guidance** – Distribute knowledge across the organization with role-specific access
- Simple and fast **onboarding** of new employees
- **Establish quality** in global business processes
- Ensure **compliance, certification & trust**
- Achieve **global process roll-out** in the context of (SAP) standardization
- Continuous **change management**

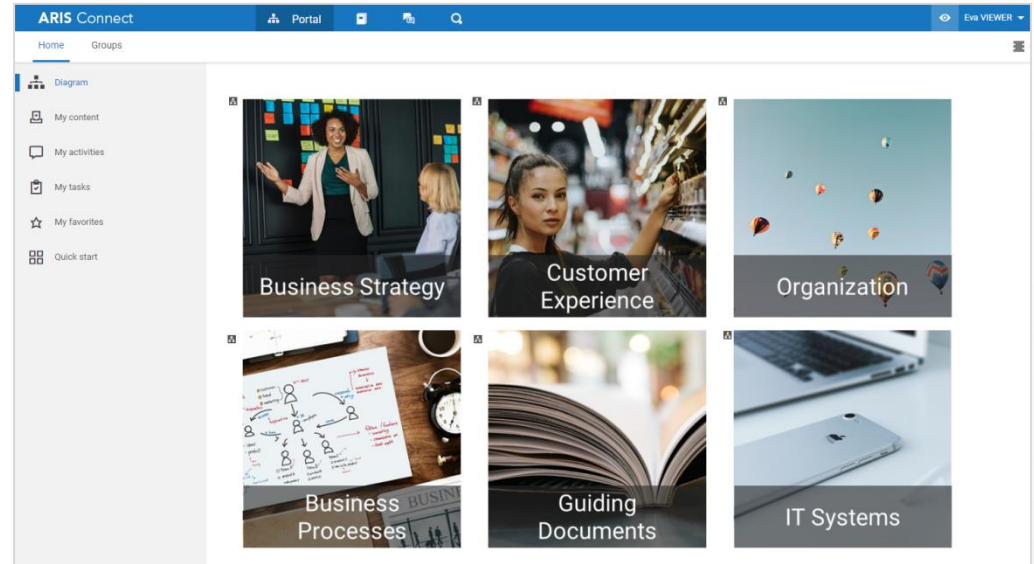

**120.000**

**ARIS users** at a Brazilian Bank

**100.000**

**ARIS users** at a UK-based retail company

**90.000**

**ARIS users** at Dutch-based tech company

# LARGE ENTERPRISE SCENARIOS

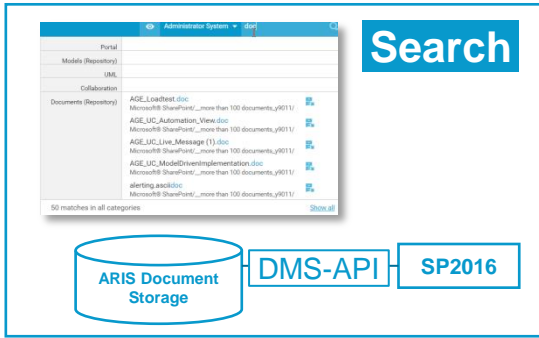

## Integration with MS SharePoint 2016

**Intelligent Document search** (to find only approved versions of documents, ..)

Mirroring the display for **Right-to-left languages** (Arabic, Hebrew, Persian, and Urdu)

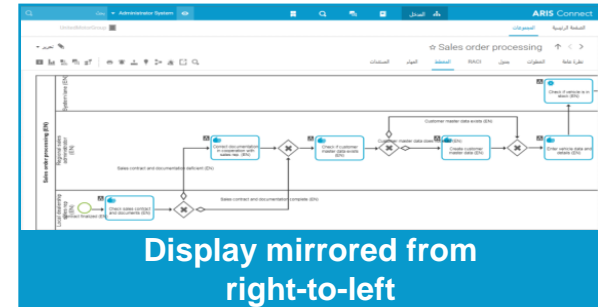
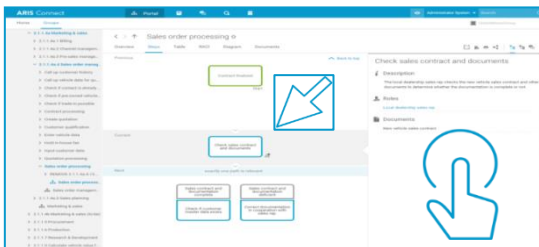

**Accessibility** through enhanced **keyboard controls**

# INTEGRATED SEMANTIC CHECKS

Symbols

Select and insert symbol (Alt + '+')

Create connection

Flags for  
errors warnings notes

- Organizational unit lane
- Position lane
- Role lane
- Group lane
- Application system type lane
- Start event
- Intermediate event
- End event
- Task
- Add/Remove symbols...

Validation of a BPMN diagram (BPMN 2.0)

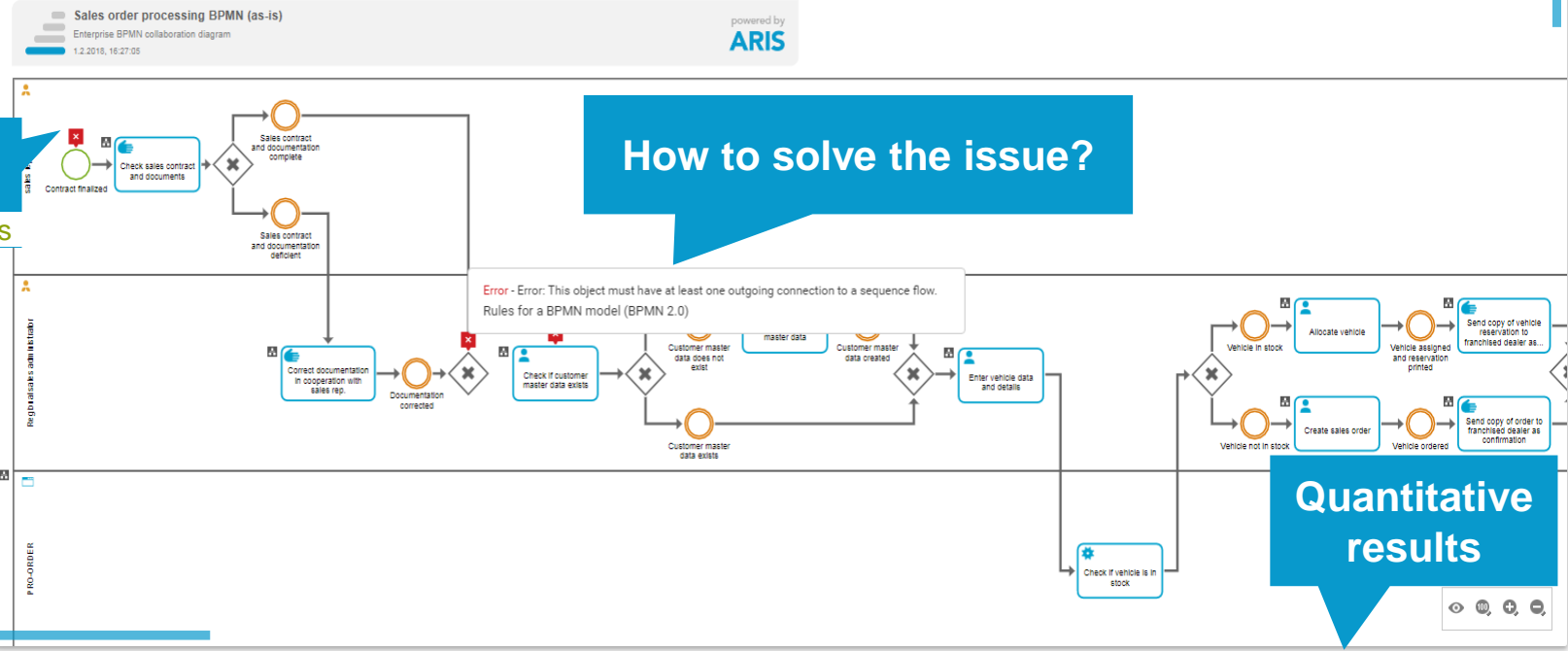

#	Item	Finding	Description
1	● Check if customer master data exists	Rules for a BPMN model (BPMN 2.0)	Error: This object must have at least one incoming connection with a sequence flow.
2	● Contract finalized	Rules for a BPMN model (BPMN 2.0)	Error: This start event violates the following rule: If a process uses objects of type 'Start event', at least one object of type 'End event' is required.
3	● Customer informed		'End event' violates the following rule: If a process uses objects of type 'End event', at least one object of type 'Start event' is required.
4	● Gateway		Error: This gateway violates the following rule: If a process uses objects of type 'Gateway', at least one outgoing connection to a sequence flow is required.

Click through step-by-step.  
See what is wrong and how to solve the issue.





# END-USER EXPERIENCE

# SMART MODELING

## EXCELLENT VISUAL QUALITY WITH EASE

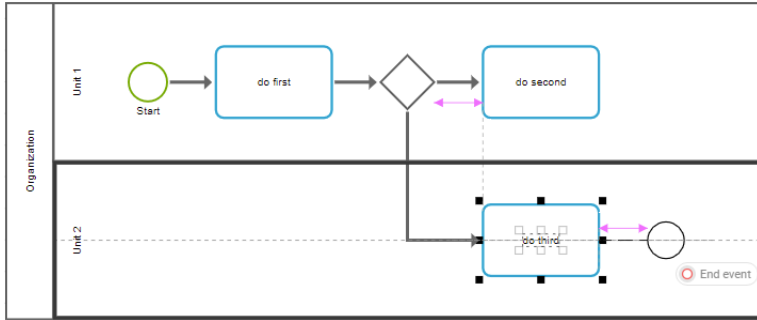

### Guided alignment

➔ Significantly reduced layout effort

### New object panel

Copy/paste from repository to ARIS Connect Designer

Improved click and place

Use of attribute groups for faster selection

Jump from ARIS Connect Designer to Portal View

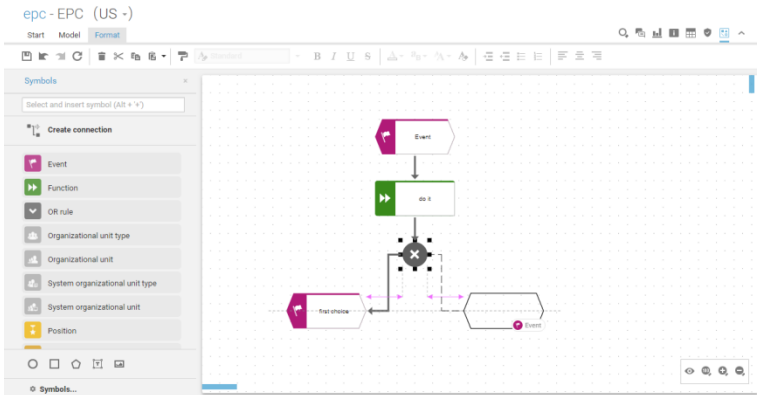

# SMART AND WEB-BASED MODELING

## UI/UX IMPROVEMENTS FOR ARIS CONNECT DESIGNER

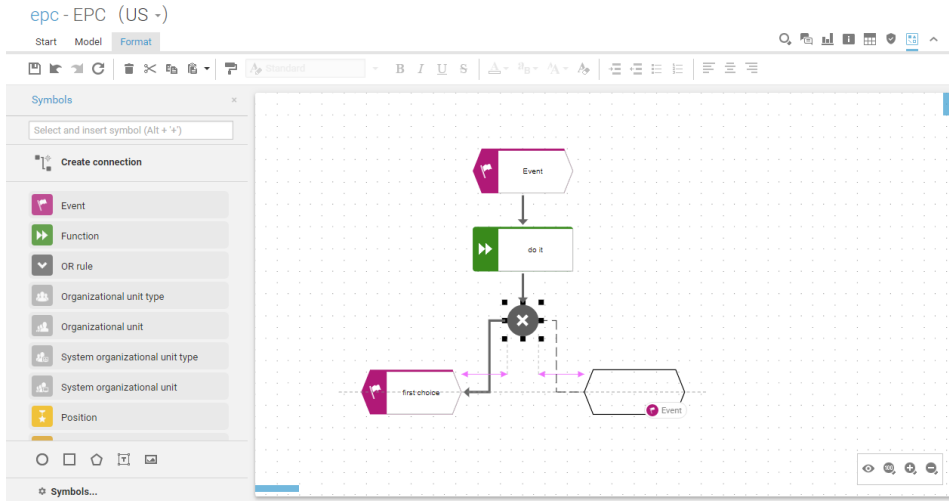

- 1 Refreshed object panel
- 2 **Copy/paste** objects from repository to ARIS Connect Designer
- 3 **Improved click and place**
- 4 Use of **attribute groups** for faster selection
- 5 **Jump** from ARIS Connect Designer to Portal View

Ease of use  
User-friendliness

All web designers

# SMART MODELING IN THE WEB ESSENTIAL FOR EVERYONE

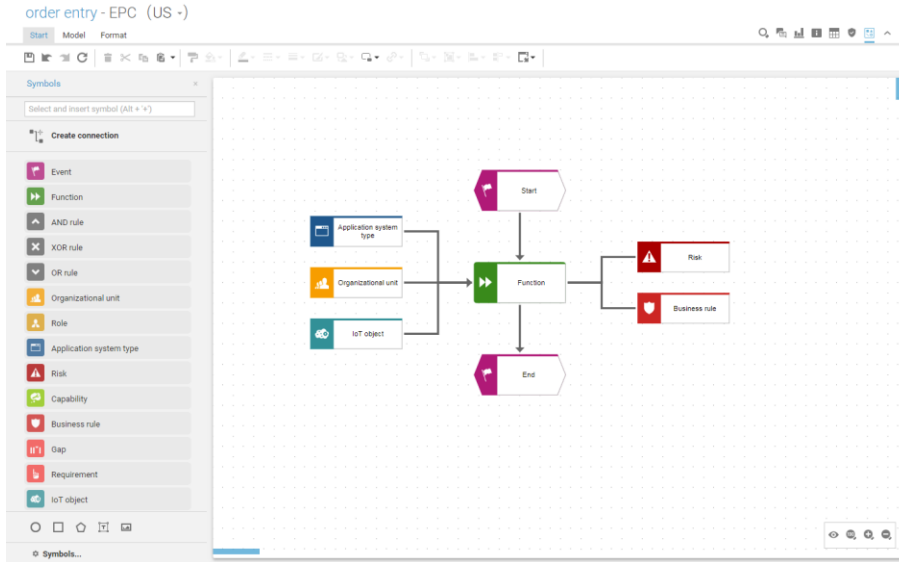

- 1 Edit the **connection styling** such as line width and bridges
- 2 Set the **background color** of a model
- 3 Get all relevant properties (e.g. GUID) of models and objects.
- 4 Improvements of the matrix modeler such as assignments creation and filtering the inspector panel

Easy transformation & improved access  
Individual styling

All designers

# LESS DESIGN EFFORTS WITH STANDARDS

## ADVANCED AUTOMATION IN ARIS CONNECT DESIGNER

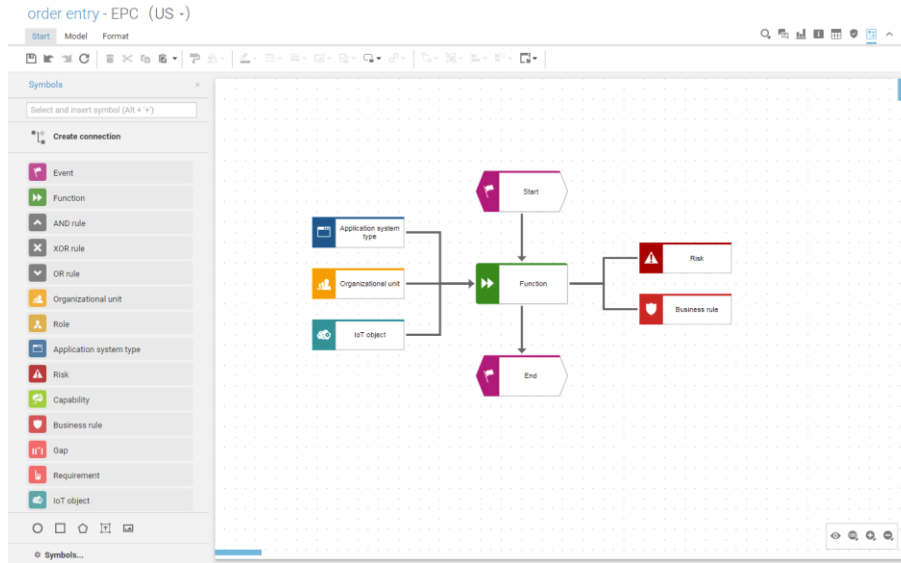

Reports can now be executed **directly after creating a model but before it is opened**. Some **sample scenarios**:

- 1 Number a model/object immediately after its creation
- 2 Auto-maintain arbitrary attributes
- 3 Object preparations

Support end-users for easy fulfillment of design standards  
Roll-out design standards across the organization

All designers  
Administrator

# APPLE SUPPORT PROCESS MODELING ON macOS® WITH Safari®



Apple® support for  
ARIS Connect  
Viewer & ARIS  
Connect Designer

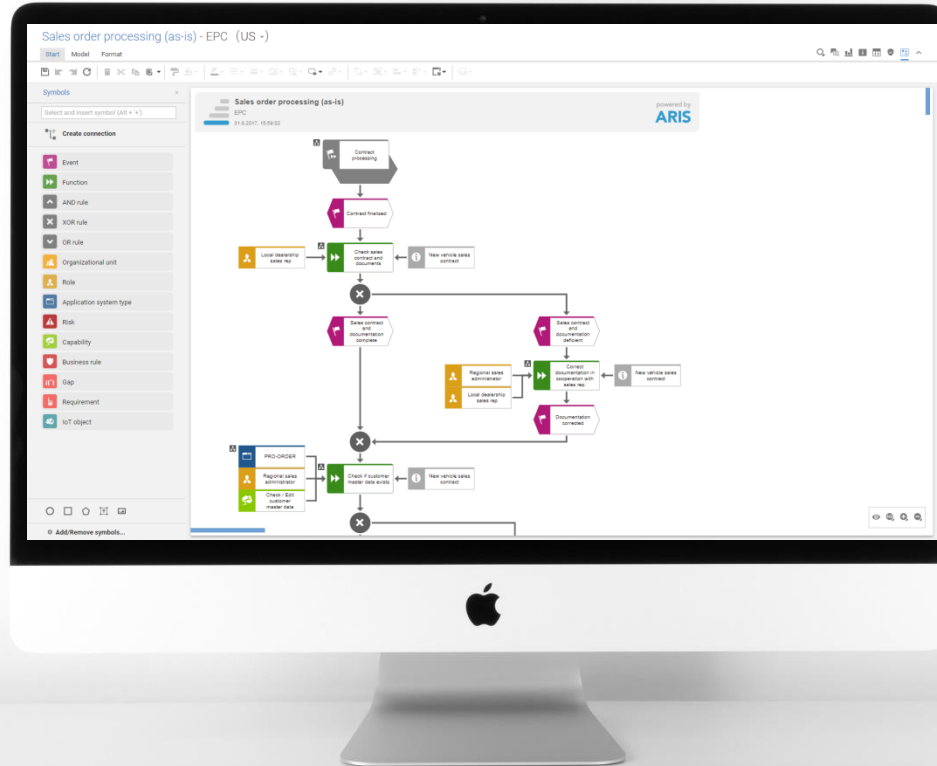

macOS® 10  
&  
Safari® 11+

# PROFESSIONAL PROCESS DESIGN

## ARIS ARCHITECT/DESIGNER

The screenshot displays the ARIS Architect/Designer interface. On the left, a BPMN diagram shows a process starting with 'Can servicing by customer request', leading to 'Advanced service team member', 'Service dispatcher', and 'Service team member'. On the right, a table titled 'Table 1' is shown with the following data:

	A	B	C	D	E
1	Objects	Cost rate	Number of employees	Cost rate (busy time)	Cost rate (idle time)
2	Advanced service team member	50.000	1.000	50.000 EUR	50.000 EUR
3	Service dispatcher	40.000	1.000	35.000 EUR	35.000 EUR
4	Service team member	40.000	3.000	40.000 EUR	40.000 EUR

A context menu is open over the table, showing options: Print... (Ctrl+P), Copy (Ctrl+C), Contents, Evaluate, and Attributes... (F8).

- 1 Improved BPMN-based round tripping: BPMN models can be replaced during import to ensure consistency in the process landscape
- 2 Copy/paste of objects from spreadsheets
- 3 Multi-selection of objects in spreadsheets

Ease of use  
Professional BPMN round tripping

Process Designer  
Automation Experts

# PERSONALIZED NAVIGATION AND VIEWING

Embed in third-party tools

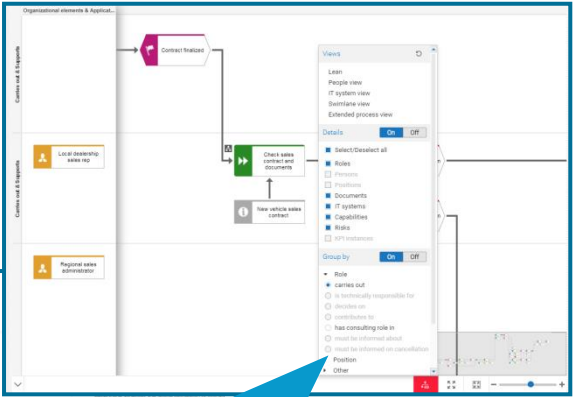
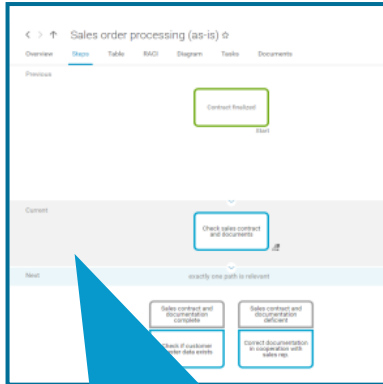

View generation 2.0 – Focus on the right details (e.g. E2E process)

Show ARIS Connect information in external systems (e.g. wiki)

Highlighting your details

Your tasks; happy path of a process



Thumbnail view, Search in diagram, Navigation

Easy & fast viewing/search



# SINGLE-SOURCE-OF-TRUTH FOR EVERYONE

## ARIS CONNECT – NOW WITH EMBEDDED VIEWS

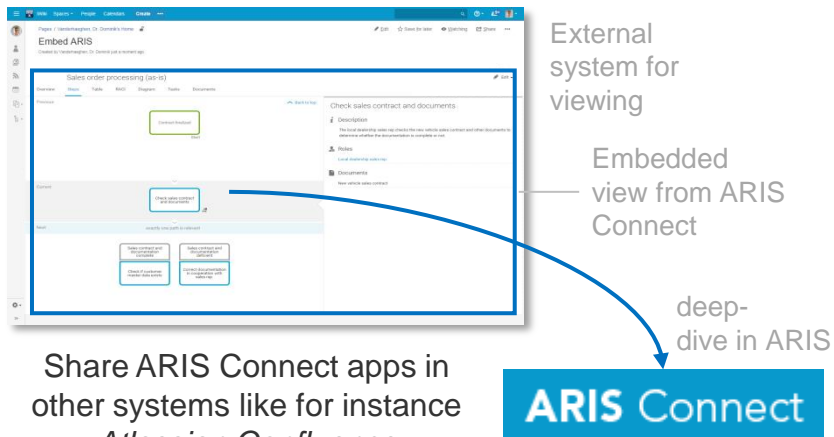

Share ARIS Connect apps in other systems like for instance *Atlassian Confluence*

**Embed ARIS Connect** within external applications (e.g. Atlassian Confluence) to reach the daily work environment of business users; publish the

- Diagram
- Steps view
- Overview fact sheet

within the 3<sup>rd</sup> party portal as simple as embedding a video player from popular video platforms like YouTube.

**Easy spread of business knowledge**

**End-users, Architects,  
Center of Excellence (CoE)**

# SINGLE-SOURCE-OF-TRUTH FOR EVERYONE

## UNLEASH NEW LEVEL OF RELEVANT DETAILS

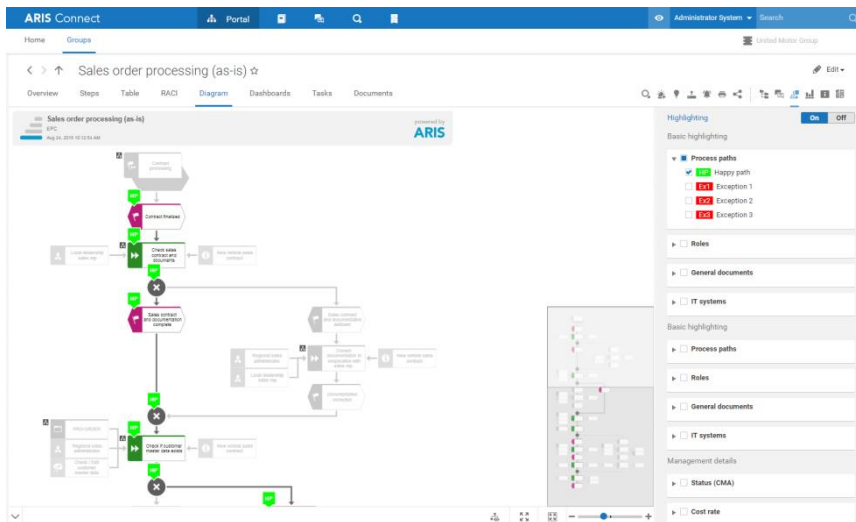

The **Happy path** visualized to guide end-users through the process

1

### Highlighting for occurrences, business patterns and connections

Users can easily highlight e.g. *their* tasks for *their* role in a process; or highlight the happy path of a process

2

### Thumbnail view

Indication where you are navigating on the canvas

3

### Connection details support

Show attributes or fact sheets for connection information

Easy spread of business knowledge

End-users, Architects,  
Center of Excellence (CoE)

# SINGLE-SOURCE-OF-TRUTH FOR EVERYONE

## ACCESSIBILITY IN ARIS CONNECT

The screenshot displays the ARIS Connect interface for 'Sales order processing (as-is)'. The left sidebar shows a navigation tree with categories like Strategy, Process architecture, Core processes, Marketing & sales, Sales order management, Sales planning, and Production. The main content area shows a process flow diagram with steps: 'Contract finalized' (Start), 'Check sales contract and documents' (Current), and 'Sales contract and documentation complete/deficient' (Next). A detailed view of the 'Check sales contract and documents' step is shown on the right, including a description, roles (Local dealership sales rep), and documents (New vehicle sales contract). A mouse cursor icon is overlaid on the 'Check sales contract and documents' step, and a hand cursor icon is overlaid on the bottom right of the diagram area.

1

### Accessibility enhancement on keyboard navigation

Enhanced keyboard controls to navigate through the ARIS Connect portal for normal end-users and end-users working with special technology (e.g. screen readers)

2

### Help page

A new help page informs on keyboard shortcuts within ARIS Connect

**Better accessibility**

**End-users,  
End-users with handicaps**

# CENTRALIZED ENTERPRISE DOCUMENTS

## NEW END-USER AND ADMINISTRATION FEATURES

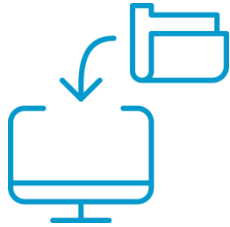

- 1 Move folders in ADS**  
Allow admins to move folders with content



- 2 Mass file migration in ADS**  
Simply migrate to ARIS Document Storage even with a large amount of files



- 3 UX improvements**  
Indication of document status in version tab  
Open documents in browser instead of downloads

---

**Integrated document & process management**

**Document owners,  
Process owners**

# ARIS IS AVAILABLE IN THE CLOUD



## ARIS Cloud Trial Public cloud

- Start your first process improvement project immediately
- Use basic modeling, analysis, admin & standard sharing



**30-day free trial!**



## ARIS Cloud Advanced Public cloud

- You already have experience in process modeling
- Advanced modeling with own filters, analysis, sharing, administration
- Manage cross-departmental projects

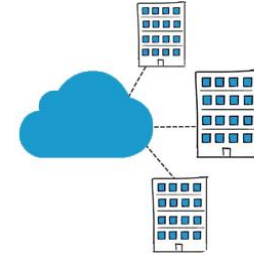

## ARIS Cloud Enterprise Private cloud

- Establish a digital transformation journey
- Enjoy complete ARIS capabilities covering expert modeling & analysis, customized sharing, full administration
- Incl. SAP, IoT, EA and GRC

# YOUR NEXT ARIS IS IN THE CLOUD

## HIGHLIGHTS



### Extended ARIS Cloud *Advanced* edition capabilities<sup>1</sup>

Public cloud extended with additional capabilities

- Advanced design and analysis capabilities with ARIS Architect made available as download client: ARIS Cloud Adv. Architect
- Enterprise Architecture Management with ARIS Architect Extension Pack EAM
- Business Strategy design with ARIS Architect Extension Pack Business Strategy

---

**New use cases in the cloud**

**Center of Excellence,  
Business Consultants**

# BUSINESS & IT ALIGNMENT



# PERFORMANCE

## STARTUP, QUERIES & SPREADSHEETS

up to

**30%**

**reduced startup time for**  
ARIS Connect Designer

**15-85%**

**reduced time for executing**  
queries

up to

**90%**

**reduced time to open a**  
spreadsheet model

---

**User experience**

**Designers, Architects & Dashboard Viewers**



# SIMPLIFIED MANAGEMENT

## AUTHENTICATION, DATABASE SETTINGS & TENANT MANAGEMENT

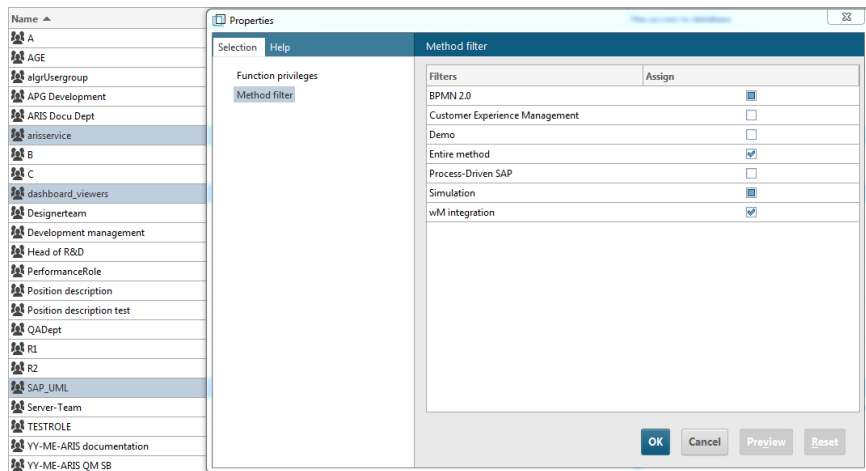

1

**Authentication handover** from ARIS  
Connect to ARIS Architect/Designer

2

**Database-related settings** can now be  
edited for multiple user groups in these steps:

- Assign access privileges
- Manage function privileges
- Access to method filters
- Specify publishing settings

3

All tenant administrators are now  
automatically **notified** about the result of  
**scheduled tenant backups**

**Ease of use**  
**Quick & easy access administration**

**Designers & Architects**  
**Administrator**

# LEADING BPMN 2.0 SUPPORT IN ARIS

## 100% ATTESTED BY OMG



### THE OMG CHECKLIST

- ✓ **Design** capabilities: Can all models of a test suite be modeled with a correct result (types, attributes, visualization)?
- ✓ **Export**: Can the designed models be correctly exported (file validity, types, attributes)?
- ✓ **Import**: Can all models of a test suite be imported correctly (visualization, objects, types, attributes)?
- ✓ **Round tripping**: Can imported models be exported again without any loss of information?



### OMG LEADERSHIP

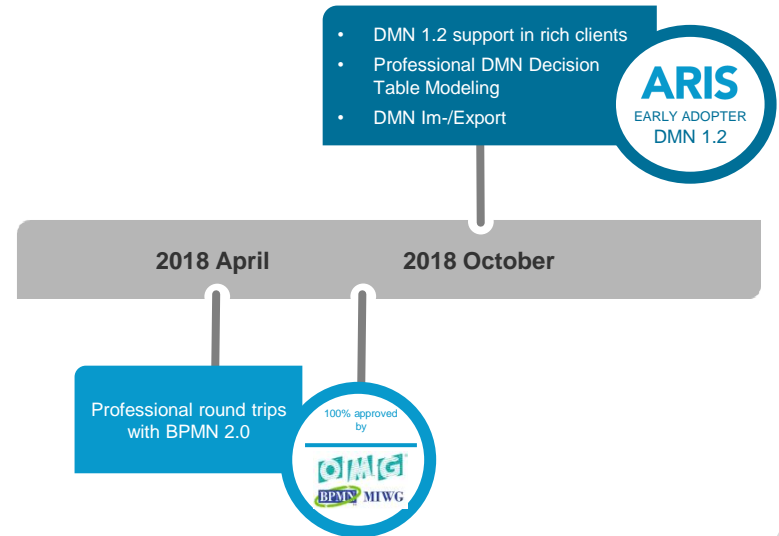

# BPMN 2.0

with ARIS 

ARIS is one of three tools with top results (100%) | 33 tools evaluated overall



Vendor	Tool	BPMN 2.0	Import	Export	Roundtrip	A Results Submitted	B Results Submitted	C Results Submitted	Website
Software AG	ARIS Architect 10.0.2	+	+ Diff	+ Diff	+ Details	+ 24/24	+ 8/8	+ 18/18	

Source: <http://bpmn-miwg.github.io/bpmn-miwg-tools/> (2018-06-20)

# PROFESSIONAL PROCESS DESIGN

## ARIS AS AN OMG CHAMPION

For ARIS 10 SR6,  
only available in  
ARIS Architect & Designer

U	Guests count	With Children	Season	Weather Conditions	Table Number	Terrace	Annotation 1
	1...4, 2, >4	Yes, No	Spring, Summer, Wint...	sunny, rainy, windy, col...	1,2,3,4,5,6,7,8,9,10,11,...	Yes, No	
1	1...4	Yes	Winter	sunny	1	Yes	
2	>4	No	Summer	sunny	5, 6, 7	Yes	
3	2	No	Summer	rainy	6		please deposit blankets
4	>4	Yes	Spring	rainy	2, 3		
5	1...4	No	Fall	sunny	4, 8, 9		
+	Create new rule						

1 DMN 1.2 Decision Modeling

2 DMN import & export

3 Decision tasks in BPMN

Easy & structured decision modeling  
Professional process automation

Process Designer  
Automation Experts

# ECOSYSTEM MODELING

## 1 Discover digitalization opportunities

Identify digitalization opportunities by visualizing the ecosystem of your organization.

## 2 Identify groups and clusters

The ecosystem consists of actors and their relationships. These can often be grouped. This helps in understanding who is driving/controlling the ecosystem. But it also makes the informational and financial flow between groups transparent.

## 3 Understanding the dynamics

Understanding how the ecosystem behaves over time is important. For example: What positive and negative dynamics can occur? Does it balance out in case of a disruption?

Business Model Canvas

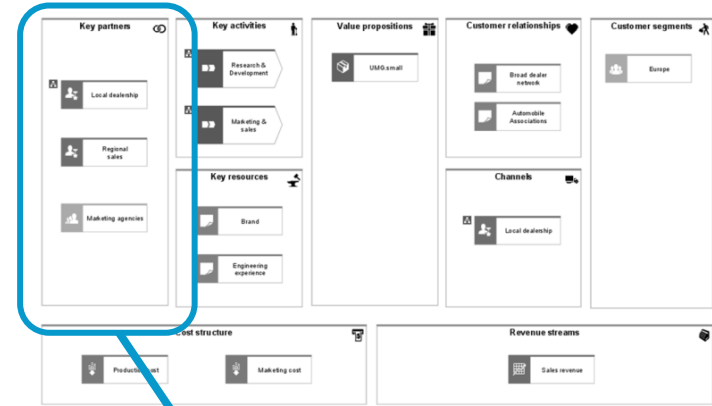

The new ecosystem model

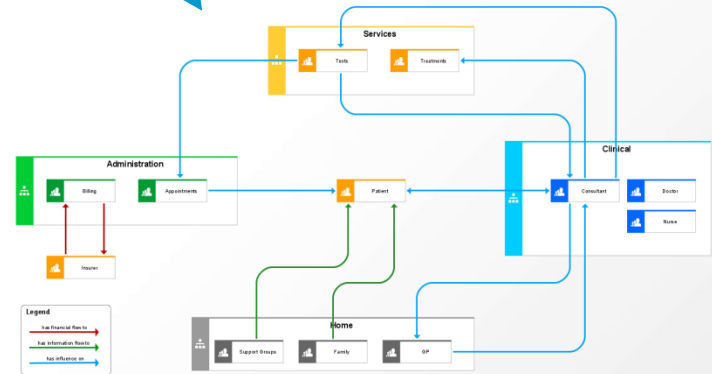

# PROCESS ADMINISTRATION ARCHIVING

1

## Archiving of completed instances

Moving completed instances to the archive can provide performance improvements, especially in heavy-load scenarios.

2

## Managing archived instances

It is possible to delete or replay archived instances. The archive is stored in the ADS. Archive related operations are stored in a dedicated history.

3

## Schedule archiving activities

The APG Report API has been extended so that archiving activities can be triggered programmatically. For automatic scheduling, the build-in report scheduler can be used.

The screenshot displays the ARIS Administration interface. At the top, there is a navigation bar with tabs for 'Processes', 'Human tasks', 'Instances', 'Variables', 'Archiving', and 'Console'. The 'Instances' tab is active, showing a table with 4 selected instances. The table has columns for Context, Status, Start time, End time, User name, Process name, Process instance ID, and Simulated. Below the table, a confirmation dialog is open, featuring a large blue 'Info' icon and the text 'Instances archived successfully.' with a 'Close' button.

Context	Status	Start time	End time	User name	Process name	Process instanc...	Simulated
Start model	COMPLETED	2018-03-17 11:57:54	2018-03-17 13:08:18	system	Initiate release cyc...	441eb89e-80fa-41...	<input type="checkbox"/>
Start model	COMPLETED	2018-03-17 11:57:52	2018-03-17 13:08:06	system	Initiate release cyc...	88d286f5-fbf3-4fe...	<input type="checkbox"/>
Start model	COMPLETED	2018-03-17 11:57:50	2018-03-17 13:07:52	system	Initiate release cyc...	007439f6-97b6-43...	<input type="checkbox"/>
Start model	COMPLETED	2018-03-17 11:57:48	2018-03-17 13:07:43	system	Initiate release cyc...	8dd8ec42-b9b3-4...	<input type="checkbox"/>

# ARIS FOR SAP® SOLUTIONS

## SUPPORT IN ARIS CONNECT DESIGNER

Wizards supporting  
**ARIS for SAP**  
compliant modeling in  
**ARIS Connect Designer**

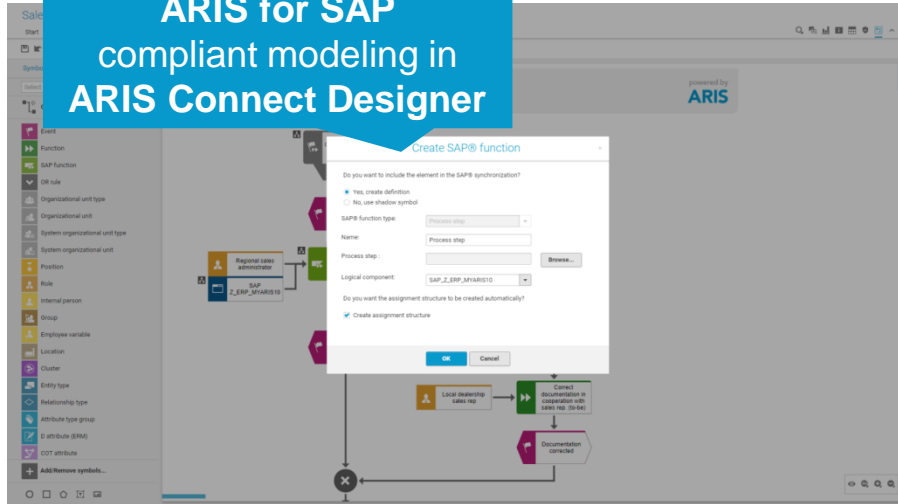

Support of ARIS for SAP modeling  
in **ARIS Connect Designer**

- 1 Wizard-based support of **modeling SAP functions** (incl. using and maintaining the Process Step Library)
- 2 Wizard-based support of **creating SAP-related documents**
- 3 Wizard-based support of **creating SAP executables** (such as transactions and Fiori apps)

Lightweight modeling of SAP processes  
Involve LoB in designing SAP processes

Line of Business

# ARIS FOR SAP® SOLUTIONS

## EXTENDED SYNCHRONIZATION AND LIBRARY HANDLING

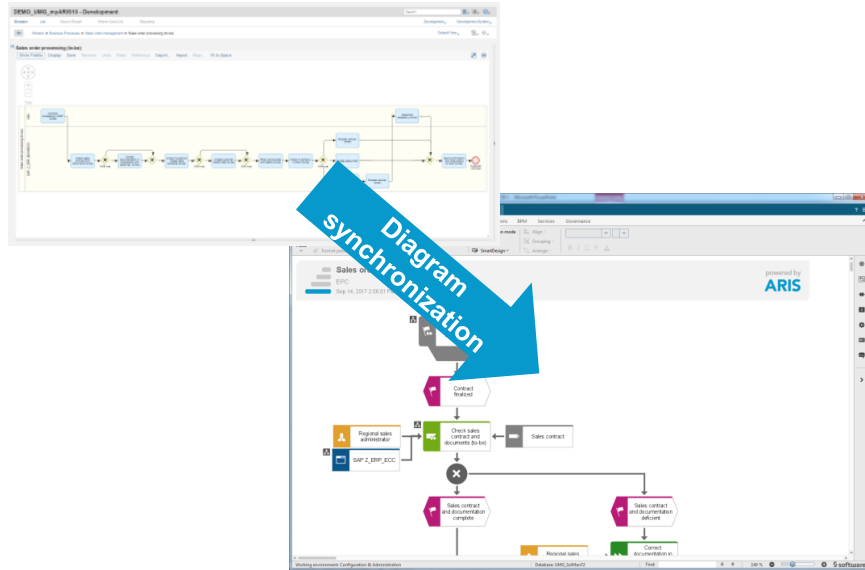

- 1 **Download BPMN process diagrams** from SAP Solution Manager into ARIS
- 2 Synchronization of **Executable Library**
- 3 **Improved synchronization performance** with SAP Solution Manager 7.2
- 4 Support for synchronizing **multi-value customer attributes** (e.g. sites)
- 5 **Start executables** (e.g. transactions, Fiori apps) in **steps view**

**Extended synchronization**  
**Better usability**

**Process Designer**  
**Process Owners**



# ARIS FOR SAP® SOLUTIONS

## INTEGRATION WITH SAP ENABLE NOW

Asset from SAP Enable Now connected to ARIS objects and models



Import Process Structures

Import Links to Training Assets

Navigate to ARIS Model in ARIS Connect during asset creation

Create training assets in Enable Now

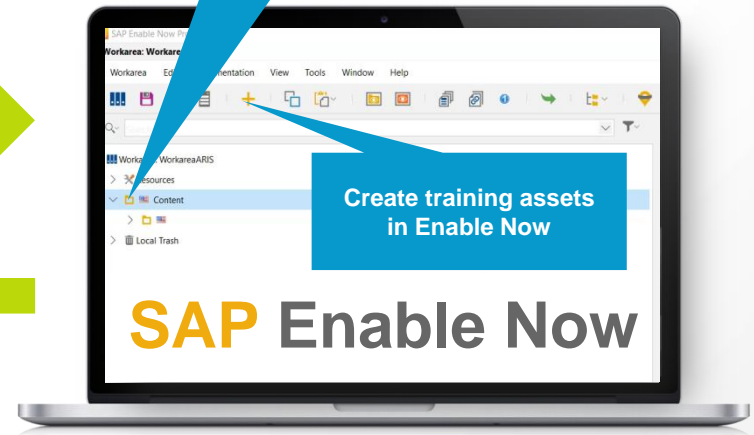

Easy creation of SAP training materials

Process Owners  
Training Manager

# PROCESS-DRIVEN MIGRATION TO SAP® S/4HANA

## ARIS IS WELL-ALIGNED WITH SAP ACTIVATE

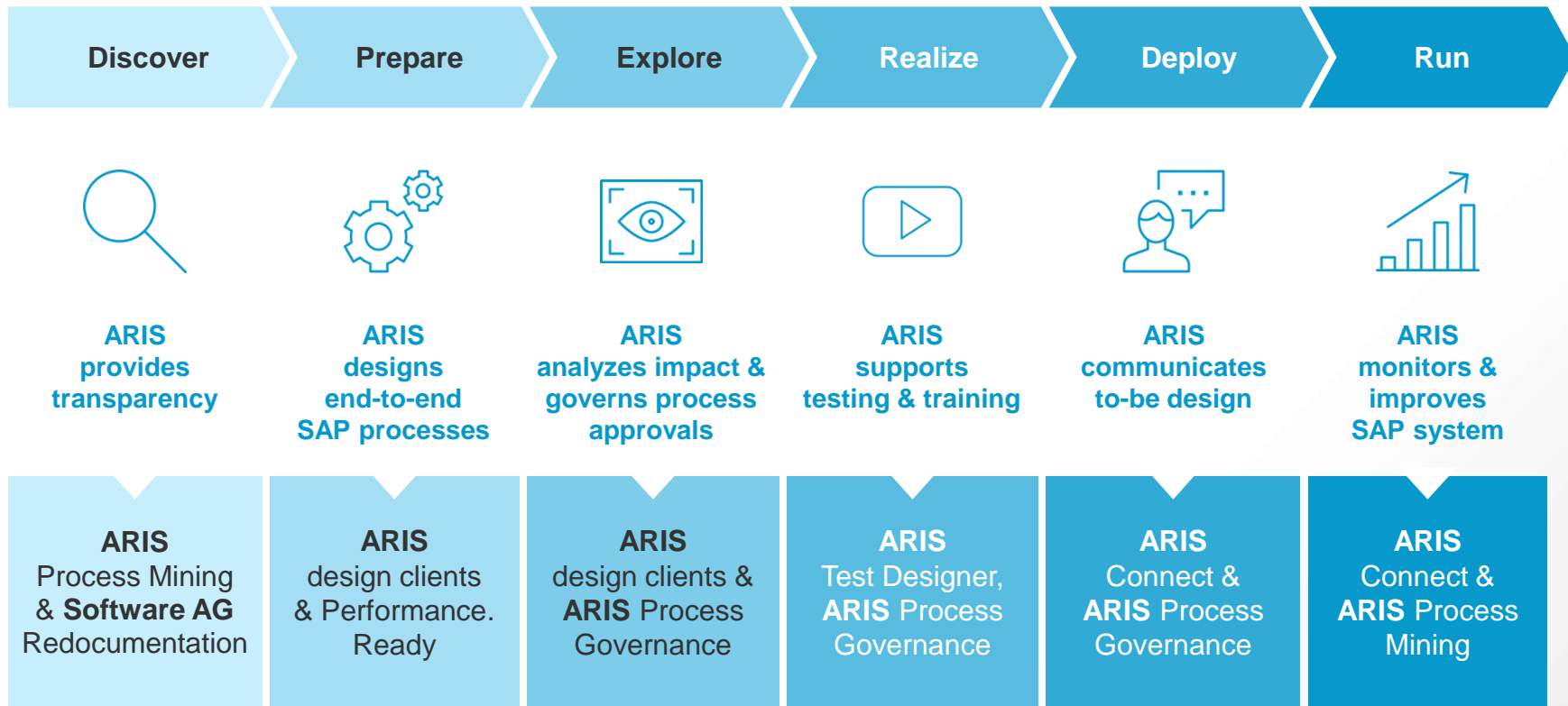

# PROCESS-DRIVEN MIGRATION TO SAP® S/4HANA

## ARIS IS WELL-ALIGNED WITH SAP ACTIVATE



### ARIS GUARANTEES

1. Transparency and understanding of status quo (processes, system)
2. The cornerstone of a successful migration to S/4HANA
3. Efficient SAP testing, training and operation



# PROCESS MINING

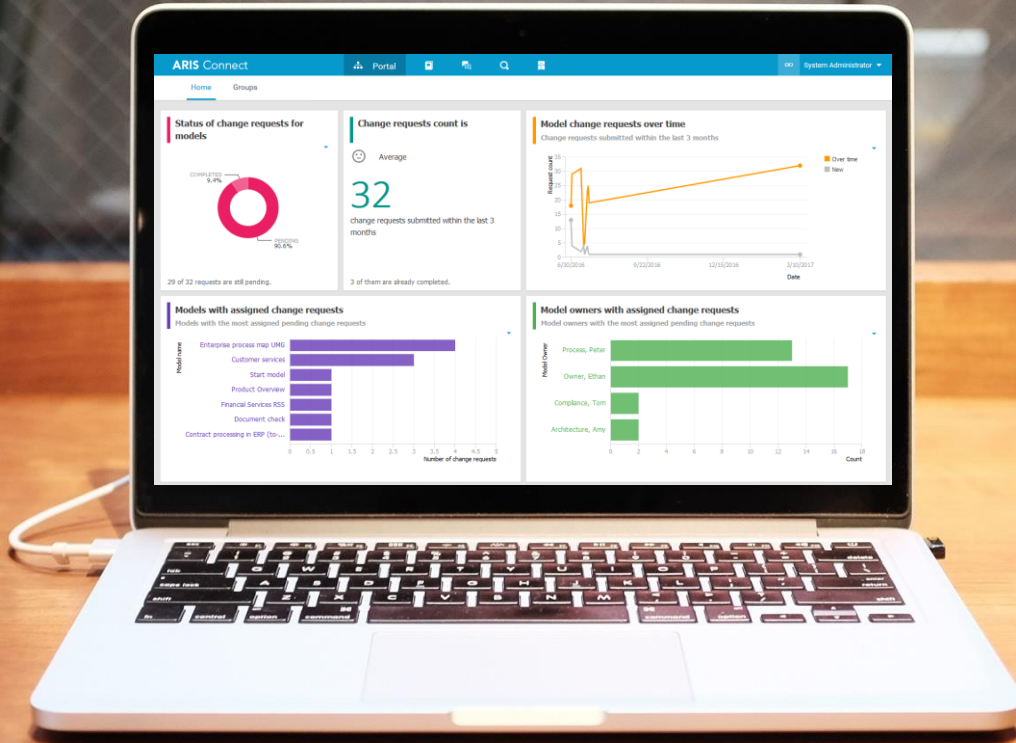

# ARIS PROCESS MINING

## INTEGRATED PROCESS MINING

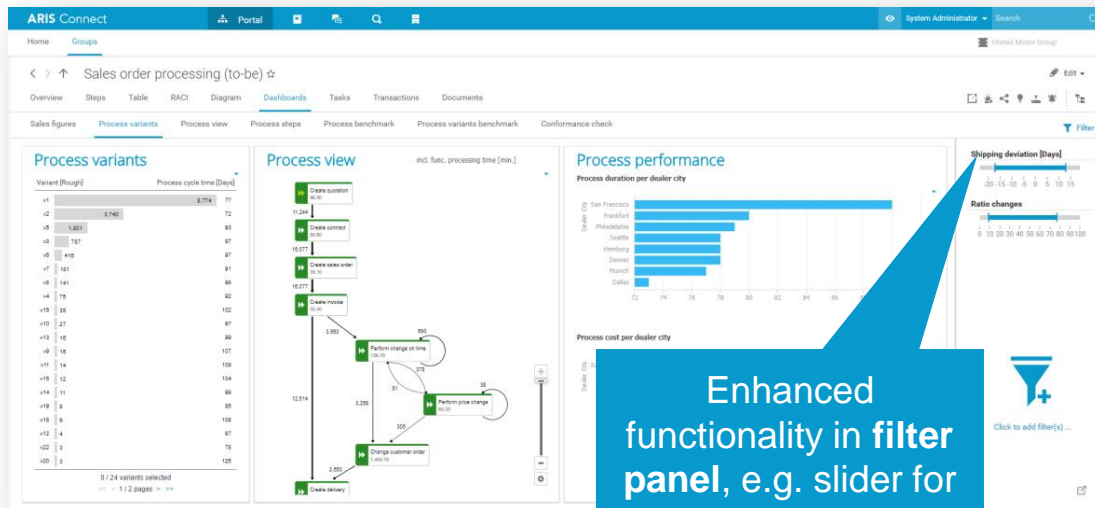

1

Enhancement in **process mining context** (e.g. slider-based filtering of process measures, exclude dashboard widgets from being filtered)

2

Enhancements in interactive **filter panel** (e.g. add dimensions at design time, slider widget)

3

Support of **process variants** in distributed systems

4

Exclude **ARIS functions** from conformance checking

Increased support for ad-hoc analysis in process mining dashboards

Process Owners  
LoB Managers

software AG

# ARIS PROCESS MINING ROOT CAUSE MINER

**1. Interactively specify symptoms in your dashboard for which root causes should be identified**

**2. Root Cause Miner will automate your process analysis**

**Root Cause Miner**  
Determine root causes for one filter set in the dashboard.

New Results

# ARIS PROCESS MINING

## ROOT CAUSE MINER

**Interactively specified symptom**  
for which root causes should be identified

Root Cause Miner

Symptom: **Process cycle time [Days]** is between 100 and 200  
16,077 instances in total, thereof 18% leading to symptom

Root causes promoting the symptom ▾

176	<b>Variant [Combined] is v5</b> 1,801 instances, thereof 37% leading to symptom
156	<b>Dealer City is San Francisco</b> 2,310 instances, thereof 33% leading to symptom
106	<b>Variant [Combined] is v6</b> 416 instances, thereof 43% leading to symptom
71	<b>Assembly location is Shanghai</b> 4,976 instances, thereof 22% leading to symptom

**Identified ROOT CAUSES**

Add selected root cause to filter panel and reset all remaining filters to the state when Root Cause Miner was started.

Apply Cancel

## Root Cause Miner

automatically identifies process root causes that influence KPIs, e.g.

**Symptom:** *processing time 100-200 days*

**Identified root causes:**

- *orders executed according to **process variants v5 or v6***
- *cars sold by dealers in “**San Francisco**”*
- *cars assembled in “**Shanghai**”*

will lead to significant higher customer complaints (*compared to “negative” influencer like London*)

## Automated root cause analysis

Process Owners  
LoB Managers

 software AG

# NEW USE CASES FOR ARIS AWARE

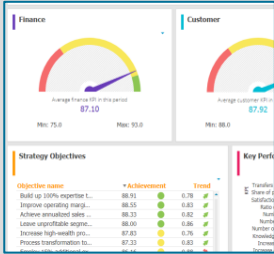

Strategy

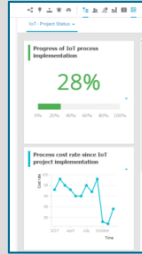

Internet of Things

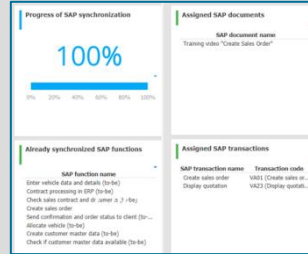

SAP Synchronization

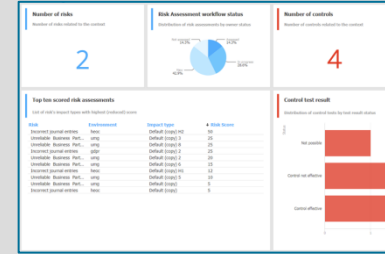

Risk & Compliance



Center of Excellence

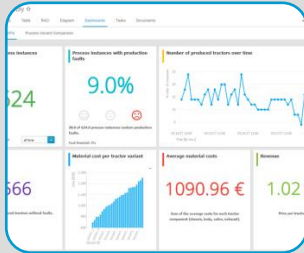

Process Performance

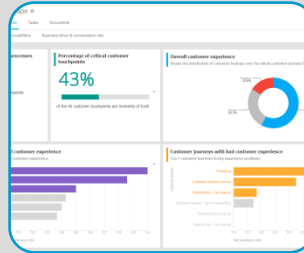

Customer Experience



Enterprise Architecture



Business Usage



# MANAGEMENT HEAT MAP

## BEST PRACTICE VISUALIZATIONS FOR RELIABLE DECISIONS

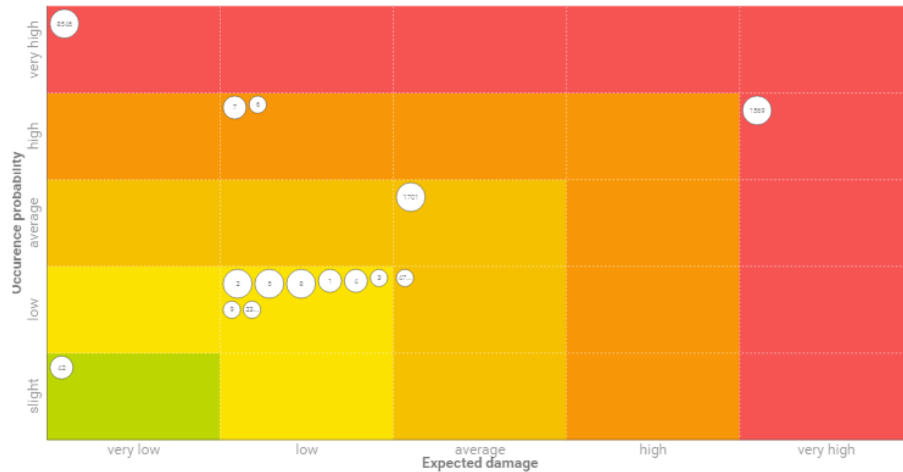

- 1 Visualize risks in three dimensions
- 2 Define your **individual** scales, colors & risk categories
- 3 Derive **actions** for critical risks – jump to ARIS Risk & Compliance Manager and proceed
- 4 Filter for specific risk categories and get the details

Intuitive & fast access to critical information  
Support reliable risk decisions

Risk managers

# GEO & VECTOR MAP

## BEST PRACTICE VISUALIZATIONS

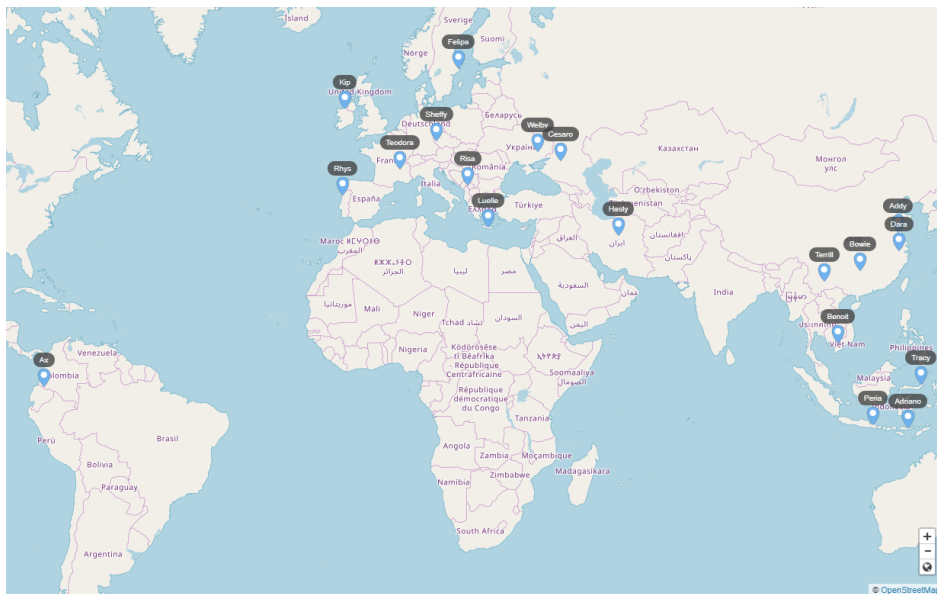

- 1 Interactive markers with KPIs in geo maps
- 2 Interactive presentation of **regions** & KPIs in vector maps
- 3 Filter on **regional** selection

Interactive world visualizations

Dashboard viewers

# DASHBOARDING WITH ARIS AWARE

## LOCALIZATION OF DASHBOARDS

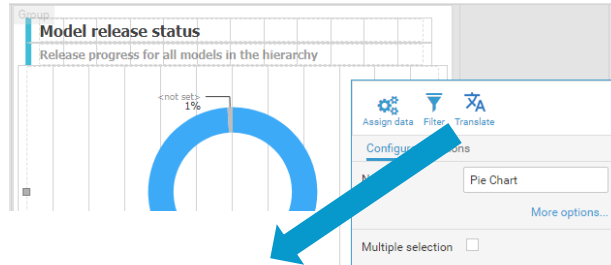

### Translations

To make the content available in different languages, select a language and translate the content of the respective table line.

Key	English(Default)	German
title	Pie Chart	Kuchendiagramm
categoryAxis.column.dis...	Status	Status
valueAxes[0].format	Auto	Automatisch
valueAxes[0].valueAxes[0]...	Percentage	Prozent
valueAxes[0].valueAxes[0]...	1234	1.234,00

Ok

Cancel

1

Improved **user acceptance** by **translating dashboards** into the user language

2

Define a **fallback language**

3

Add additional languages during your **translation projects**

4

Works for tabs, chart dimensions, etc.

Dashboard in my own language  
Intuitive & fast dashboard translation

Dashboard viewers  
Dashboard designers

# DASHBOARDING WITH ARIS AWARE FURTHER IMPROVEMENTS

## Configure axes presentation

The screenshot shows a configuration panel for a chart. At the top, there are icons for 'Assign data', 'Filter', and 'Translate'. Below these are tabs for 'Configure' and 'Actions'. The 'Configure' tab is active, showing a form with the following fields:

- Name: Column chart
- Multiple selection:
- Chart title: Please enter a chart title.
- Rotate x-axis labels:
- Legend position: None
- Axis: Show all
- Editing: Show all, Hide title, Hide all

A 'More options...' link is visible below the Name field.

Optimize charts for different  
screen resolutions

## Entering exact slider values

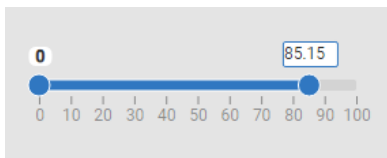

Some use cases require an  
exact definition of value  
ranges. The value slider now  
allows entering values  
directly on the range points.

## Dynamic images

### Select image source URL

Please select the image source URL

Source:    
Default Source:

Additionally you can define a dynamic URL using  
selections. You can also take a selection from a  
component on another tab.

1 |

Configure Input

Using dynamic URLs allow to  
flexibly change images based  
on particular selections.



# GDPR COMPLIANCE

# MAKE DATA PROTECTION PRACTICES A HABIT BEYOND THE DEADLINE OF GDPR

Data protection shouldn't end as a deadline met. Instead build a sustainable practice across your organization and turn data privacy protection into a competitive advantage:

- Establish data policies
- Evaluate the implications for your industry
- Build a record of processing activities
- Perform data protection impact assessments
- Implement risk mitigation measures
- Establish incident management
- Ensure sustainable compliance

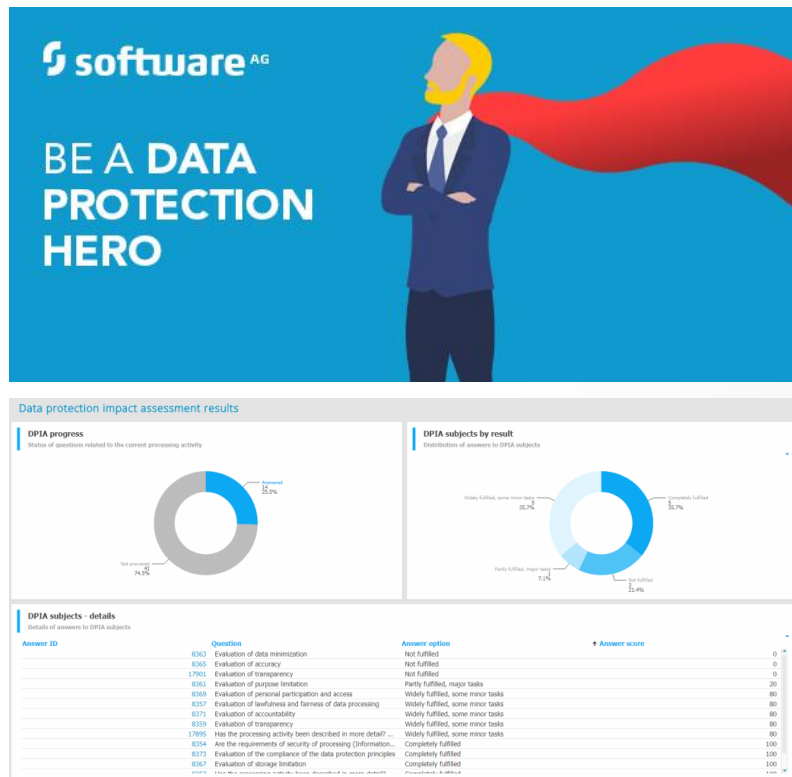

# GDPR AND BEYOND HIGHLIGHTS I

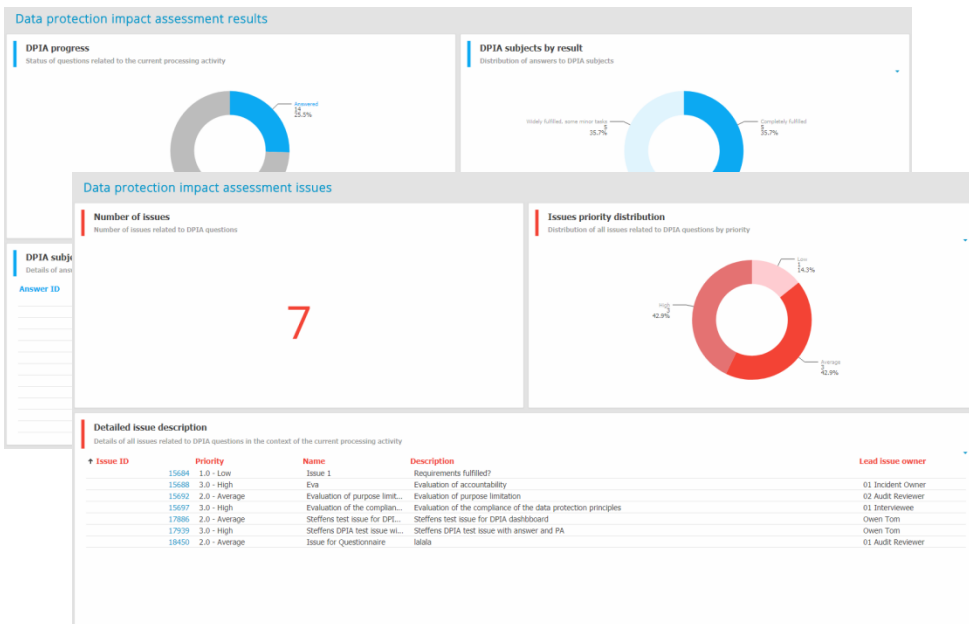





- 1 Questionnaire template for **Data Protection Impact Assessment (DPIA)**
- 2 **DPIA report**
- 3 **DPIA dashboard**
- 4 **Separate Processing Activity Documentation (PAD) questionnaire templates for controller and processor**

**Next steps to GDPR Compliance  
Improvements**

**Compliance Manager  
Data Protection Manager**

# GDPR AND BEYOND HIGHLIGHTS II

<input type="checkbox"/>	Name ▲
<input type="checkbox"/>	 GDPR application system qualification
<input type="checkbox"/>	 GDPR Data Protection Impact Assessment
<input type="checkbox"/>	 GDPR processing activity documentation (Controller)
<input type="checkbox"/>	 GDPR processing activity documentation (Processor)

- 1 Questionnaire template for application system **qualification**
- 2 Improved fact sheets for **control** and **function**
- 3 Reduced set of **mandatory** attributes

**Improvements**  
**Adjustments based on customer feedback**

**Compliance Manager**  
**Data Protection Manager**



# IMPROVEMENTS GRC: DATA ACCESS FOR ARIS AWARE HIGHLIGHTS

The screenshot displays the 'Answer (questionnaires)' configuration page in ARIS AWARE. The interface includes a sidebar with a tree view of navigation options: Administration, Risk Management, Survey Management (with sub-items for Answer, Data, Sections, and Data), Sign-off Management (with sub-items for Data), and Test Management (with sub-items for COSO components, Data, Execution, and Data). The main content area is titled 'Answer (questionnaires)' and features a 'Generate link' button. It is divided into two sections: 'General' and 'Answers'. The 'General' section includes a 'Language' dropdown set to 'English', a 'Sorted by' section with 'Object' (Answers), 'Attribute' (Environment), and 'Order' (Ascending) dropdowns, and a 'Result size' input field. The 'Answers' section includes three filter rows: 'Environment' (Equal to), 'ID' (Equal to), and 'GUID' (Equal to), each with a dropdown menu and an adjacent input field.

1

Access to **sign off**

2

Improved access to **hierarchies**

3

Access to **control execution**

4

Improved access to **surveys** and **questionnaires**

**Out-of-the-box**  
Full access to ARIS Risk & Compliance Manager data

Management  
Dashboard builders

# FURTHER GRC IMPROVEMENTS HIGHLIGHTS I

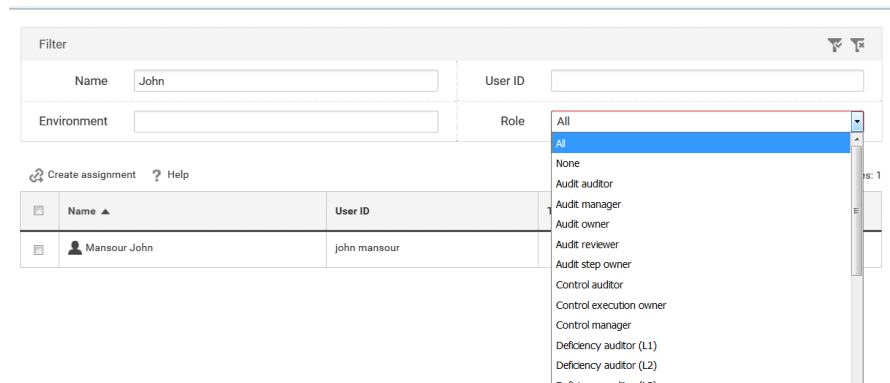

1

Control auditor role

2

Control execution tab added to hierarchies

3

Simplified user assignment to issues

4

Simplified/reduced set of mandatory attributes

Closer and more complete integration  
Ease of use

ARCM Users

# FURTHER GRC IMPROVEMENTS HIGHLIGHTS II

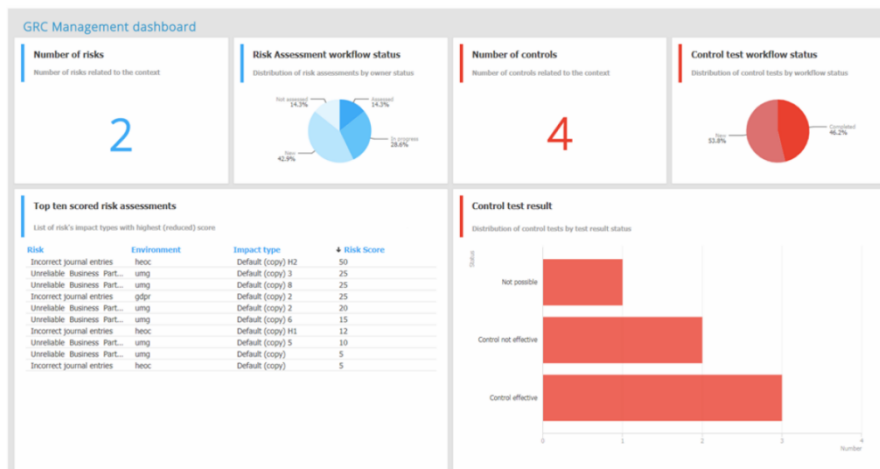

- 1 Import of **complete hierarchies** without having assigned GRC elements
- 2 Descriptive information for questions and answers available in **offline processing**
- 3 **Remark field** for every role
- 4 ARIS Aware **dashboard for GRC**

Improved information about business aspects  
Improved feedback for all users out-of-the-box

Operational ARCM users

